

# INDIA FIRST MAGLEV IAT-UNITY FEASIBILITY REPORT & BUSINESS PLAN



Chapters	Page No
1: PREFACE.....	3
2: ABOUT THE TRANSPORTATION PROJECT.....	4
3: ABOUT THE DIRECTORS OF THE COMPANY.....	7
4: WHY THIS IDEA?.....	8
5: WHY THIS PROJECT IN CHENNAI.....	9
6: EXECUTIVE SUMMARY MTC TRANS.....	10
7: SALIENT FEATURES OF THE PROJECT.....	14
8: CHENNAI INTRODUCTION.....	16
9: STATION.....	32
10: THE MAGLEV.....	62
11: OPERATIONAL.....	67
12: THE DEPOT.....	76
13: PILLARS.....	89
14: THE GUIDEWAY.....	99
15: POLYGON TYPE MID SPAN CONSTRUCTION.....	102
16: RENEWABLE ENERGY – OUR POWER SOUR.....	112
17: SIGNALLING AND TRAIN CONTROL.....	139
18: AUTOMATIC FARE COLLECTION.....	151
19: SAFETY & SECURITY.....	152
20: FUNDING.....	160
21: FINANCIAL VIABILITY, FARE STRUCTURE & OPTION .....	168
22: ECONOMIC APPRAISAL.....	175
23: ENVIRONMENTAL IMPACT ASSESSMENT.....	188
24: GLOBAL MULTINATIONALS AND MTC TRANS SYSTEM.....	212
WORKING MODEL – SNAPSHOTS.....	214
MTC TRANS RAPID SYSTEM MAIN PILLAR PLAN	
MTC TRANS MAIN STATION PLAN	
MTC TRANS INTERNAL STATION PLAN	
MTC STATION GROUND FLOOR PLAN	
MTC TRANS PLATFORM LEVEL 1 PLAN	
MTC STATION FIRST FLOOR PLAN	
MTC TRANS STATION PLATFORM 2 PLAN	
MTC TRANS RAPID SYSTEM	
DEPOT PLAN 2 ACRE LAND	



## **PREFACE**

The past two decades have seen a growth in population, increased urban sprawl, vehicle ownership, traffic volume and economy far greater than what was thought likely and it is fair, proper and reasonable to anticipate the concomitant transport problems such as congestion, pollution and environmental hazards. To solve the traffic and transportation issues, CMDA initiated the third comprehensive study viz. Chennai Comprehensive Transportation Study (CCTS) in the year 2007, designed to provide the broad parameters for the long term development of transport infrastructure setting objectives for the next two decades, with the horizon year as 2026, with a Vision as spelt out in the Second Master Plan by the Chennai Metropolitan Development Authority – “to make Chennai a prime metropolis which will be more livable, economically vibrant and environmentally sustainable and with better assets for the future generations.”

It has been our privilege to serve the interests of Chennai metropolis in meeting the travel demand envisaged in formulating this comprehensive transportation plan. The process of replicating the “real world” transportation system and forecasting the state of the system at some future time is the crux of transport demand modeling adopted in the study. Earnest attempt has been made in the formulation of proposals of the integrated transportation system capable of accommodating the projected travel demand by appropriate plans, policies, programmers, priorities and phasing. The goals set, took the inputs of the stakeholders in preparing the SMP that was in conformity with the guidelines of NUTP and approved by the committees constituted for CCTS. The mobility strategies developed have resulted in a number of transport proposals that are categorized into short, medium and long-term measures. The study has emphatically brought it to the fore that the long term goal of ensuring mobility lays in the development of appropriate modes of public transport system and more particularly in the provision of high order mass transit systems, to be in tune with the avowed policy of moving people rather than vehicles. The study addresses challenges arising from shortcoming in the existing transport networks as a result of limited investment over decades for want of financial resources. We have identified financial mechanisms that accumulate capital funding for deficit correction and expansion; including private participation wherever suitable. We have incorporated the latest study techniques and have put in our best efforts and in doing so, we believe that we have brought out recommendations, the translation of which into reality will set the pace for significant development of Chennai metropolis, contributing in no small measure in making it a preferred destination for major investments.



## 2 - ABOUT THE TRANSPORTATION PROJECT

The *MTC TRANS Rapid System* “MTC TRANS,” means Metropolitan Transportation Corporation, is a new, high-tech, maglev magnetic light rail based entity focused on zero-emission, self sustaining operations, with core competencies in urban planning, passenger transportation, and smart growth. With the support of world-class strategic partners, **IAT-INNOVATIVE ACCESS TEAM** has the potential to spawn a new, global high-tech industry with compelling appeal from both a financial and environmental perspective will provide a royalty perpetual license of its proprietary technology to MTC TRANS in exchange for such equity rights. All assets, infrastructure, marketing agreements, leases and easements will remain the property of *Unity Infra* initially, “MTC TRANS” will design, finance, build and operate a 41 km Sustainable Green Energy Transportation Systems utilizing licensed proprietary magnetic levitation (“Maglev”) technology to carry passengers between the Mamallapuram to Thiruvanniyur Bus Stand entrance. Serving both the patrons parking lots and the citizens of the surrounding will provide green, seamless connectivity for up to million riders per year replacing the dozens of diesel powered buses that currently operate along this corridor on a daily basis.

### **Who is Unity Infra Transit Project Implementers**

A transportation specific project implementers, has hunger in taking up more and more transportation projects in India. We are based in Chennai.

This enterprise was started in 2012.

We have 8 members in our team presently will grow as a major corporate in the years to come, headed by Mr. Dhoulat sah and Mr. Heeralal Bhora

**UITPI** engaged itself for preparation of the detailed project report for Over Head MMDDRTS System for rail system. This executive summary deals with MTC TRANS system only.

### **What is MTC TRANS?**

MTC TRANS is the name assigned for this particular transportation project which is likely to be started in CHENNAI. So, it is named as **Metropolitan Transportation Corporation**.

### **Maglev Magnetic Double Decker Rapid Transit System (MMDDRTS)**

MMDDRTS systems have been the subject of future-looking visions for many years. Maglev Magnetic systems do have a major drawback though; the trains can only run on the rail in one direction at a time, effectively meaning the construction and maintenance efforts for implementation take twice the cost and space.





Now, a German company, **INNOVATIVE ACCESS TEAM – (IAT- MAGLEV)** has the potential to spawn a new dynamic to the configuration that hopes to make the transportation system even more economical and greener. The Double Decker system proposed by **IAT-MAGLEV** even has one of the patent owners **IAT-MAGLEV** investing 100 million Euros to the first project that will tackle the construction of the system in the next two years - regardless of the country. The company is now looking for partners to make their revolutionary new traffic system a reality. Possibly even Elon Musk might like the idea as part of his Hyper loop concept.

The Double Decker, single-beam design runs with integrated implementation and locking solutions, and is intended for personal and freight vehicle traffic. Electronically controlled levitation magnets allow the railway to be suspended - without wheels, axles or overhead lines. The friction-less electro-magnetic system facilitates speeds that go beyond 40 up over 300 km/h - with maximum travel comfort. The “Double Decker **IAT-Maglev** Magnetic Trans System”, however, has huge advantages compared to the conventional Trans rapid system including CO<sub>2</sub> reduction, reduced sound emission (as there is no engine or friction noise). **IAT- MAGLEV** is also proposing along with personal transport. **IAT-MAGLEV** Trans could be installed with solar panels in each 100 km track length to enables us to make the maglev environmentally friendly and cost-effectively.

The developers also claim that improved safety will result due to their automatically-run system-security vehicles that travel ahead of every personal Trans, and connected to the control mechanisms to shut the system down in case of failure. Along with personal transport, **IAT-MAGLEV** is also actively promoting their solution for the freight and logistics industry. For corporations and governments, the implementation of the Magnetic Double Decker System investment in structural and operating costs will be markedly reduced suggests the company. This would be accomplished via the use of a beam in a Double Decker upper/lower carriageway system instead of the previous one-tiered system. **IAT-MAGLEV** also claims the **MTC TRANS Rapid System** build Double Decker **IAT-MAGLEV** Magnetic Trans that expensive tunnel and junction solutions would be minimized with their solution. Moreover, they say their Double Decker will substantially relieve freeways and roads, taking the strain off that area of infrastructure.

The **MTC TRANS Rapid System** build Double Decker **IAT-MAGLEV** system is our response. **UITPI** has proposed to build urban railway network as a backbone and to introduce nick named as **Parakkumbus** – 42km of new transit network in its master plan for year 2016 has developed a plan to improve the transport system by organizing systems. Development Institute has suggested designing an inner circular route to assist to supplement the current network, which is concentrated on all the direction. The inner circular route can connect internal trip, and reduce the use of private vehicles. The proposals of new transit system introduction and necessity have been discussed, however in conceptual level, and the feasibility of the new transit in terms of



economic and financial aspect has remained unstudied. Here, we define new transit as a transportation mode which has automatic guiding system with independent routes, **IAT-MAGLEV** Double Decker Trans System, and present a detailed proposal for the first phase which is to be built for 42kms.



***IAT- Maglev Magnetic Double Decker Transrapid System Ground Level***



### 3 - ABOUT THE DIRECTORS OF THE COMPANY

**Mr. M. Dhoulat Sah.**

**FOUNDER, DIRECTOR -UNITY INFRA PROJECT IMPLEMENTERS.**

Active member for the execution of projects under unity infra project implementers concern.

A very hardworking, effective team player, leader in real life.

Email: dhoulatsah@gmail.com

**Mr. B. Heeralal Bohra.**

**CEO - UNITY INFRA PROJECT IMPLEMENTERS.**

A very hardworking, effective team player, leader in real life.

Email: bheeralal@gmail.com

**Dr. Smarajit Roy. Ph.D(BRUNEL UNIVERSITY )**

**INTERNATIONAL PROJECT GENERAL CONSULTANT**

UNITY INFRA PROJECT IMPLEMENTERS.

He is heading this project and unity infra team. He is working as a director for City Wastes Bioenergy Solutions – UK lecturer in entrepreneurial management in London. Heads shows interest in executing and has sound knowledge about MANY BIOENERGY PROJECTS across the globe.

Email: ceo.cws@gmail.com

#### **OUR PRINCIPAL SHAREHOLDER**

**We sincerely thank the principal shareholder CEO Walter J. Neumann, Social Scientist, National Economist and Project Developer, President of The United Nations Millennium Project Germany, Chairman of IAT-MAGLEV Group**

and

**CTO Mr. Dieter Schramek, Founder of The IAT-MAGLEV TEAM, Chief Technical Officer Construction Development Engineer.**

The Technology is from “IAT-INNOVATIVE ACCESS TEAM (IAT-MAGLEV) – Germany”, patent rights holders for the “Maglev Magnetic Double Decker Trans System”, led by Mr. Walter J. Neumann and Mr. Dieter Schramek.

**We are grateful to INNOVATIVE ACCESS TEAM NRW from Germany for signing the MOU with us and cooperate in this green project implementation.**



**Mr. Walter J. Neumann**  
**CEO IAT - INNOVATIVE ACCESS TEAM**



**Mr. Dieter Schramek**  
**CTO IAT - INNOVATIVE ACCESS TEAM**



## 4 - WHY THIS IDEA?

Natural resources in India are very fast depleting by all means due to unplanned methodologies, fast growth in population, accidents etc. So, here is a time to make use of the more readily available renewable energy resource (we use solar power) available in abundance across the world, combining with the most innovative non-polluting, noise less technology (The Maglev) for minimal expenses and maximize profits and to provide the maximum safety in all fronts in this light rail system.

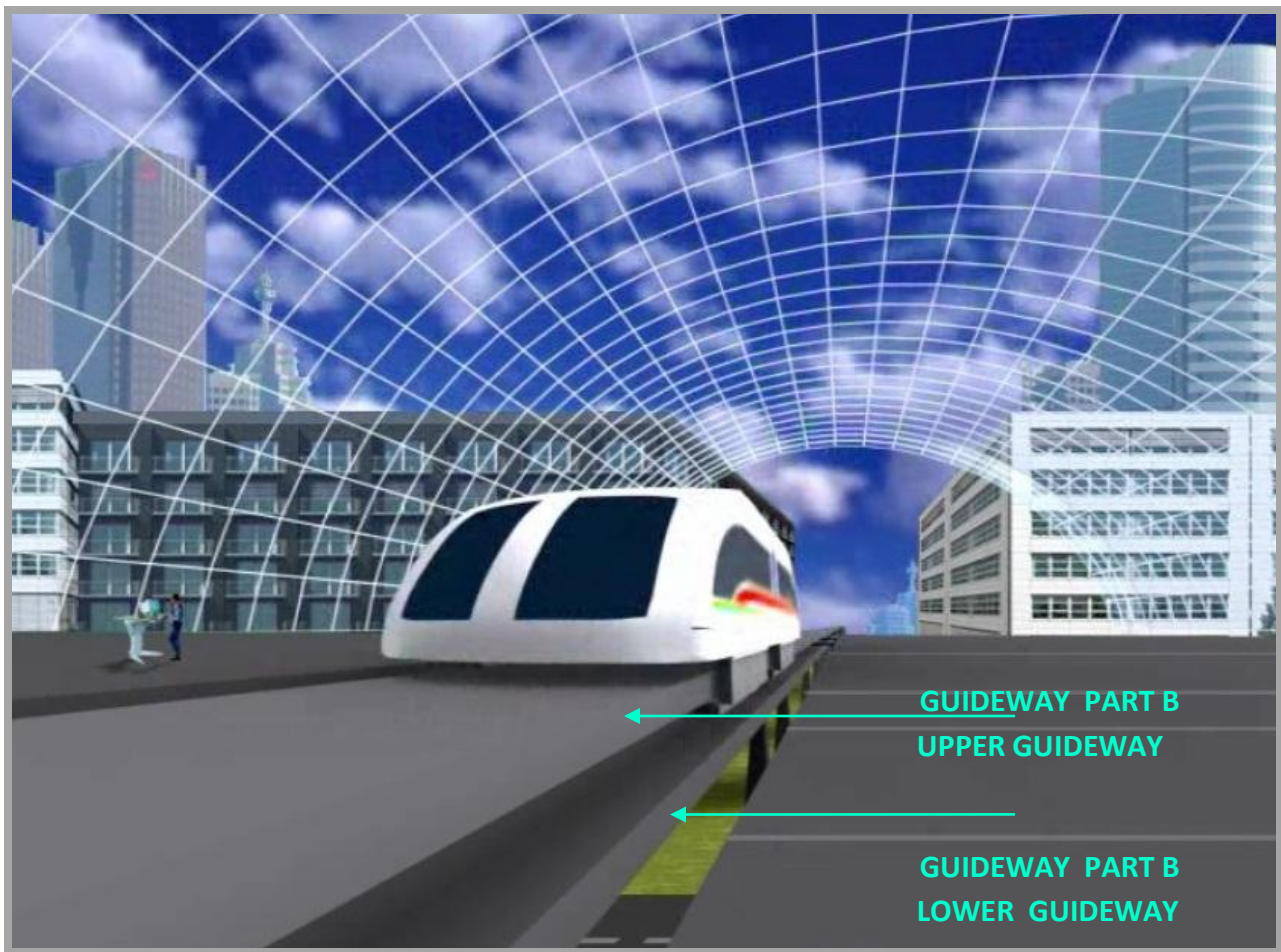

**IAT- Maglev Magnetic Double Decker Transrapid System Ground Level**





## 5 - WHY THIS PROJECT IN CHENNAI?

Chennai is a vast and fast developing city in all economic fronts with many natural resources readily available. Moreover, transportation plays a vital role in everyone's life in India. The population in India is heavily on the rise, where transporting people and freight by the safest means is an important challenge.

Maglev technology in rail transportation is the proven one across the world in safety, time saving, non-polluting and various other reasons at par making it the safest means of transportation in the world.

Other countries in the world have already changed or changing at a very fast phase towards tapping and using the different sources of renewable energies, one being the solar power.

While Chennai is just a starter on this front.

The Chennai city and its surrounding metropolitan area have a population of nearly 8 million. This generates about 11 million passenger trips a day, with about 6 million vehicular trips. The ever-growing vehicular and passenger demands, coupled with constraints on capacity augmentation of the existing road network, have resulted in significant road congestion during peak hours of the day. Most of the roads in Chennai's central business district are congested, and roads in older areas have inadequate or poor geometries. An inadequate orbital road system, with a lot of missing links, has put tremendous strain on the radial network.

There is a strong need for an efficient transportation system in the city, and the people of Chennai have long felt the need for an efficient, economic, and reliable rail-based mass transit system that would augment and complement the existing modes of public transport

This is the right time to combine the renewable energy resources (solar power in particular that is used in this project) and the most innovative, safe, technologically advanced transportation system to achieve the best in Chennai.

So, **Unity Infra Transit Project Implementers** have started the initial phase of combining these two into one namely "MMDRTS Rapid Transit System and very soon and the first of its kind to be implemented in India through **Unity Infra Transit Project Implementers** under the project name "MTC TRANS".





## 6 - EXECUTIVE SUMMARY MTC TRANS

- Unity Infra Transit Project Implementers executes the above rail transit project under the name “**MTC TRANS**”.
- **IAT- Innovative Access Team** is holding the patent rights for the “Maglev Magnetic Double Decker Rapid transit System will be partnering technical us to unity infra execute this project.
- Right of the way and depot land will be acquired from the Tamil Nadu Government for the depot. Additional land will be acquired from the government or private parties according to the requirements.
- Total number of **MTC TRANS** stations: 36. The main vehicle depot will be likely 500 meters from the **Mamallapuram To Thiruvanmiyur Bus Stand**, The route length is 42 kms.
- Powered and runs on solar power coupled with maglev (magnetic levitation technology).
- Land allotted for main depot = 2 acres for vehicle depot and 100 acres land for solar power plant to generate 20 MW DC power daily basis.
- 20MW DC power generated in the main power, system & station needs. 750 / 415 VDC power is separated from the 6MW and is totally used to run the system. The surplus power is sold to the Tamil Nadu Electricity Department.
- The Traction Power (used to move the 750 VDC is generated from the main solar power plant).
- A traction sub-station takes control of 4 **MTC TRANS** stations for maintaining the 750 VDC power for traction purpose throughout the route.
- There are 36 stations for which 4 traction sub-stations (TSS) will be installed, thus  $4 * 9 = 36$  stations. So, 4 sub-stations will be taking care of 4 stations to maintain 750 VDC power to keep the rail car moving along the total stretch.
- The Auxiliary sub-station (ASS) power (33 KV/110KV Alternate current) is used only for the station electrical utilities like AC's, Escalators, lightings etc inside and around the stations. This power is got from the Tamil Nadu Electricity Department grid station to all the stations through cabling.
- Solar panels will be installed at the top of station roof tops, depot and on the upper portion of the guideway upon which the system moves to generate additional DC power.
- UNITY INFRA Power Plant Farm is a 20 Megawatt electricity generation plant designed to produce electricity by solar energy in Chengelpet.
- The 20 megawatt power plant planed has is use of transit project is divided into 20 independent segments of each MW.
- Calculation of the consumed power in stations will be paid to the Tamil Nadu Electricity department by Net-Metering policy
- Batteries for storing the generated solar power will also be provided in the main solar power station itself.



- For safety and security reasons, SCADA systems will be installed in main depot, and stations, all substations (both Traction sub-stations and Auxiliary sub-stations) etc to provide the maximum safety.
- All essential places will have DC generator sets, switches, etc to prevent power failure.
- The frequency between each rail car will be around 6 minutes.
- The total car body is built with Aluminum.
- The Depot will have separate areas for servicing, separate rakes for stabling the cars.
- Safe and secure Depot Control Center (DCC),
- The car moves or travels along the Guideway, made up of Reinforced Metal concrete.
- This system is fully automatized with Signalling and pilot less car travel also.
- Automatic driverless trains depot use only diver handle the system
- Convenient services provided every few minutes in peak periods
- A stabling and maintenance facility at **Mahabalipuram at Poonjeri Entrance depot**
- Has a linkage with other forms of transport
- To provide fast, convenient, efficient, modern and economical mode of public transport system.
- To properly integrate with other modes of transport.
- To de-congest the ever growing road traffic.
- To provide reliable transport system with fixed travel time.
- To provide a reliable all weather, all season transport system with no need to worry about rain, water clogging, political processions, public meetings and human chains.
- To provide an environment friendly means of transport.
- New stops can be added easily after construction. Safety minimal disruption during construction takes minimal amount of road space can operate .since light rail runs on the street new stops can go just about anywhere along the street .but adding a MTC TRANS station stops requires constructing an
- Elevated platform with stairs and elevators Light Rail Transit is 60% cheaper
- Suspended Light Rail Transit low inertia trains can be accelerated and decelerated on a very rapid frequency service using relatively limited power.
- Fast Transportation every two - three minute passengers to get Air Conditioned up to 40 to 460 km/h speed travel facility, covering distances at about 45 km/hr. average speed.
- Minimal Land Acquisition Problem. In this new technology of `MTC TRANS system`, Minimal land acquisition will be required, except for providing for right of way on existing roadways.
- No capsizing If at all derails, cannot fall down coach keeps hanging.
- Hence no capsizing takes place as compared to railways and underground metros.
- No Pollution Aesthetically pleasing & no noise pollution, environment friendly.
- No waiting there is **MTS TRANS** every 3/6 minute.
- Tourism Enjoy the bird's eye view of your city.
- Completely automated with access control by means of electronic prepaid cards.



- Stations act as access facilities only and not as passenger holding areas.
- Double walled light shells with wide large windows are from **MTC TRANS** system bogies
- Air conditioned and with automatic doors
- Audio visual information to passengers
- Special 4m or 2x2m wide sliding doors for quick entry and exit of passengers
- Every vehicle will have two rail coaches with a capacity transporting.
- Each passenger's cabin can carry up to 120 passengers.
- Coaches running in upper of the guidway and another two rail coaches is suspended in same guidway in down side MTC TRANS's system.
- Amenity Senior citizens and differently enabled persons have lift facility.
- The MTC TRANS system consists of a concrete box structure carried over
- In the middle of roadway pile foundations support columns spaced at 15 m along the roadway in the median of the road.
- Luxury, Clean and comfortable cafes, business centers, restaurants and communication facilities with health parks made available on MTC TRANS STATION, thus adding to urban space.
- MTC TRANS will not impact the existing other modes of transport in any way.
- Thus, till the construction is over, other modes of transport like the railways and roadways will not be affected at all.
- The MTC TRANS System track derailment is impossible. So, the suspended rail is one of the safest modes of transport in.
- The ticket fares of the MTC TRANS will be very less.
- Thus, people will use the public transportation system instead of private vehicles reducing the burden on the roads With less traffic, roads will not remain crowded and traffic jams will be much less.
- To provide an efficient, hassle free, safe transportation alternative to a common.
- MTC TRANS is completely run in solar power operational on electricity
- Smooth operational efficiency and satisfactory working conditions, Secure stabling of the vehicle fleet, including any standby vehicles and dedicated service/maintenance machines, Depot buildings with workshop facilities for undertaking light, medium and heavy maintenance,
- Washing plant for exterior cleaning of vehicles,
- Safe and secure Operating Control Center (OCC),
- Safe and secure room to energize flexible power connection
- Safe and secure rooms for storing materials and supplies,
- Administrative support facilities and amenities for employees,
- A safe, pleasant and comfortable working environment,
- Road entrances and exits for heavy plant vehicles, delivery and emergency vehicle access,



- Additional space and service roads to load and unload supplies and equipment, Minimum environmental impact. All installations shall be in line with a Sustainable, Green and Environmental Friendly Depot concept.

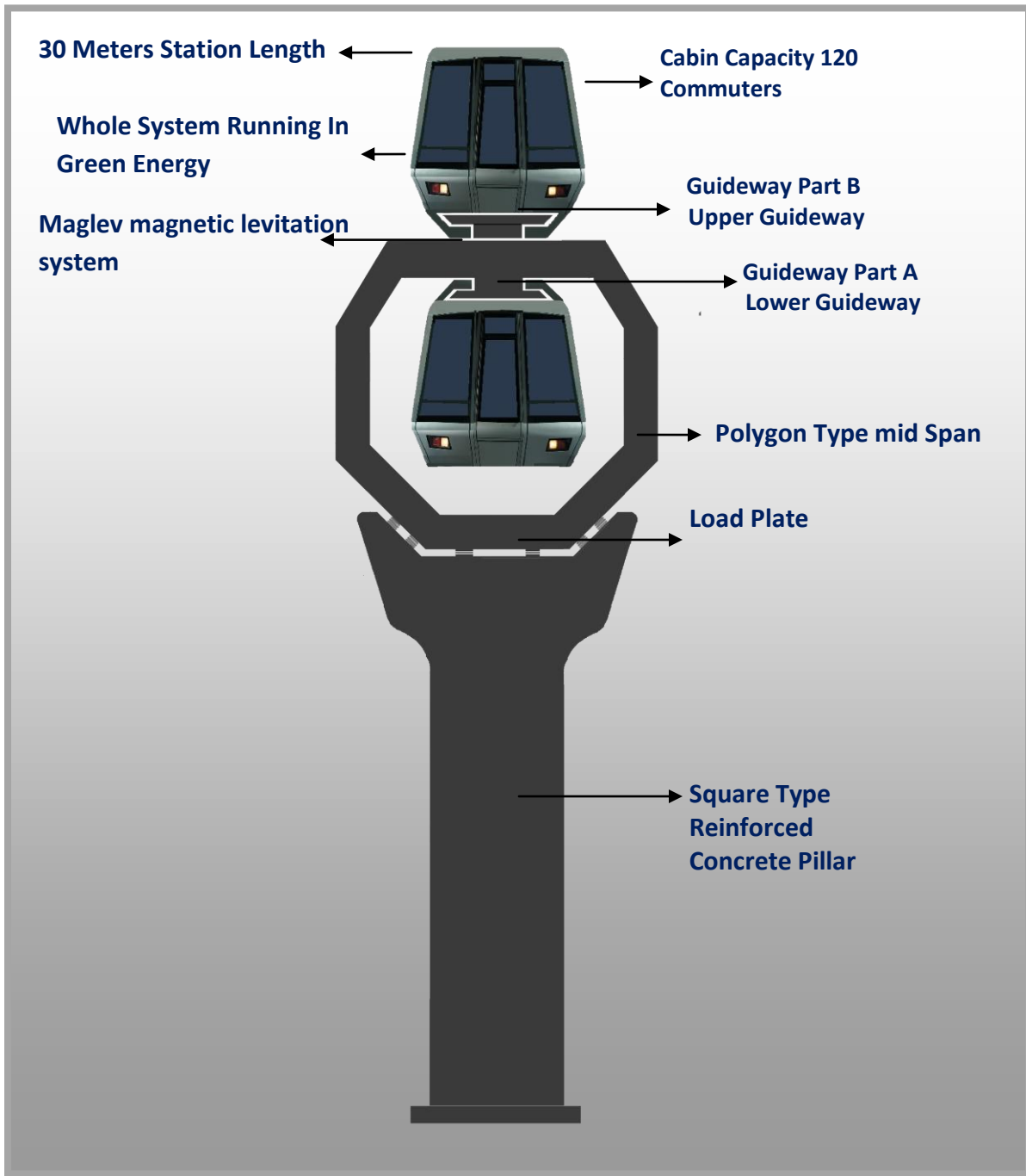

**IAT- Maglev Magnetic Double Decker Transrapid Elevated System**



## 7 - SALIENT FEATURES OF THE PROJECT

### Route length

Route Length	42 Km (Fully Elevated).
Number Of Stations	36 Nos. (All Elevated).
Track	Reinforced Metal Concrete Guideway.

### System Design

Station Dwell Time	20 seconds.
Train Composition	Two set rail car 24 coach (Aluminium).
Average Speed	30.0 Kmph.
Max. Speed	480 Kmph.

### Traction Power Supply

Power Supply source	20MW DC power generated from solar energy.
SCADA system	Provided.

### Financial Indices FIRR

Particulars	Completion Cost	\$	Firr%
Completion cost with taxes	4079.00	\$ 613 million	17.09%
Completion cost without taxes	3316.00	\$ 499 million	19.52%

### Estimated Cost (January 2015 prices)

Particulars	Estimated Cost (excluding IDC)	\$
Without Any Taxes	3316.00	\$ 499 million
With Central Taxes& State Taxes	763.00	\$ 114 million

### Signalling, & Train Control

a) Type of Signalling	Communication based train control with cab Signalling and ATO – Driverless Operation possible.
b) Telecommunication	Integrated System with Fiber Optic cable, SCADA, Train Radio, PA system etc.

### Maintenance Facilities

Maintenance Depot	Mahabalipuram at Poonjeri Entrance Ground Level Depot .
-------------------	---





### Rolling Stock

2.7m wide 3.9 metres high 12.5 length modern Maglev magnetic rail car.	Two rail coach.
Net load	Less than -15 ton.
Capacity of coach unit	50+80 passengers depending upon car configuration and seating & standing capacity to be discussed with the car manufacturer during final design.
Class of accommodation	One
Rake requirement in 2019	24 nos

### Completion cost INR & \$

<b>Completion Cost Estimate</b>	<b>INR Rupees</b>	<b>\$</b>
Total project Cost without tax	33,158,746,328.00	\$499,000,000
Details of Taxes and Duties	6,778,639,900	\$10,1383,373
Contingencies @ 3 %	941,788,728.00	\$14,253,867
After the completion the project expenses	136,080,000.00	\$2,059,096
After the completion the project revenue	2,759,400,000.00	\$41,757,446
Advertisement Revenue	2,880,000	\$43,586
ATM space in station Revenue	6,480,000.00	\$98,069
Shops	6,480,000.00	\$98,069
Admin executive's expenses	13,737,600	\$207,935

### Project Plan

- The detailed project report (DPR) is likely to be submitted very early pending approval of DPR by State Government of Tamil Nadu .
- Setting up an executing body which will take action regarding,
- Land acquisition. Preliminary planning.
- Getting legal status for project implementation.
- Seeking necessary Tax relieves and other clearances from the Central Government.
- Co-ordination with utilities and other Civic and Government Body.
- Engaging Consultants for preliminary design and Tendering.
- Fixing of BOOT concessionaire. Project & Construction Management (through Consultants).
- Act as Regulatory authority during Operation and Maintenance. Plan for future expansion.
- Approval of DPR by Central Government. The approval is required in principle to provide legal cover and tax concessions. Provide legal cover for the project.

The project can be implemented in 3 years after sanction of the project stated above. The preliminary works can be taken up immediately after approval of DPR by the state government. Actual execution of works can start in early 2015 and commissioned in phases.



## 8 - CHENNAI INTRODUCTION

Chennai is the fourth-largest city in India. It is a coastal city with the second largest beach in the world. The climate is hot and humid but the breeze blowing from the sea makes the climate bearable. It is India's major leather-producing center and the quality of leather compares with the finest in the world. The City with its present population of about 8 million generates about 11 million trips in a day, with about 6 million vehicular trips. The ever growing vehicular and passenger demands coupled with constraints on capacity augmentation of the existing network have resulted in chaotic condition during peak hours of the day.

### Population

The population of Chennai in 1639 was 40000 and today the city is estimated to have a population of 7.5 million, which gives a population density of about 6482 per sq. km. It is observed that with the population growth between 1921 and 1981 has been very rapid and similar trend continues.

Chennai is well connected by road, rail and air with all the main cities and towns in the country and its airport is one of the busy hubs on the world map. Chennai is situated centrally and is a gateway to various southern tourist destinations in Kerala, Karnataka and Andhra Pradesh. Well connected to other states in India – North, East and West, one can visit any corner of the country from Chennai. Chennai boasts of world class educational institutions. There is a lot of scope for higher studies and research for students. Chennai has a number of research institutes where a lot of new research is promoted. Institutes like the Central Leather Research Institute, Adyar, the Institute of Mathematical Sciences, DRDO, IGCAR and the M.S Swaminathan Research Foundation are some of the research organisations of great repute.

Chennai with its excellent linkages to major international and domestic destinations is the most preferred estimation for manufacturing and new economy industries. The City is home to major automobile majors and is also attracting substantial investments in this sector and other allied industries enhancing its competitive advantages in the region. The economic base of CMA is very strong and is poised to grow at a rapid pace with the development of specialized economic zones such as the IT corridor, IT Park at Siruseri, Mahindra Industrial Park Limited etc.

The increase in travel demand with population and vehicular growth, declining share of public transport, with considerably enhanced reliance on the personal motor vehicle has led to increased costs due to travel delays, loss of productivity, deteriorating air quality caused by automobile exhausts and an increased incidence of road accidents. While these are the problems of today, tomorrow's picture is more worrying. Chennai Metropolitan Area's increase in overall growth will require an adequate and efficient transport system to meet the anticipated population by 2026.



Existing transportation problems would get compounded and become chaotic if not adequately addressed. From the future needs apart from mobility corridors and transportation systems, intensive improvements are essential for correcting deficiencies. In the light of these trends, the current study provides optimal solutions, focusing on a larger comprehensive thought process and on policy issues on the need to ‘move people –rather than vehicles’.

### **Bus Transport**

The MTC operates approximately 640 routes with a fleet of about 3300 buses. The fleet strength is depicted in the Figure. During peak hours, the buses operate with more than 100 passengers per bus indicating substantial overcrowding. The MTC covers most of the CMA and even covers up to 50 km beyond the city.

### **Metro Railway**

A metro system is under construction to meet the future urban transport requirements. It opened its doors to the public on June 29, 2015. Totally 7 corridors have been proposed. In first phase, two corridors are under construction. Three corridors have been proposed in the second phase. There are also plans for extending Corridor 1 till Wimco Nagar.

Corridor 1: Washermanpet — Chennai International Airport (under construction)

Corridor 2: Chennai Central — St. Thomas Mount  
(under construction, Koyambedu to Alandur running)

Corridor 3: Moolakadai — Thiruvanmiyur (planned)

Corridor 4: Moolakadai — Mogappair (planned)

Corridor 5: Mylapore — Poonamallee (planned)

### **Rail Network**

The rail infrastructure in the Metropolitan area basically comprises of following sections of railway which are treated as suburban sections:

(I) North line towards Gummidipoondi (BG line)

(II) West line towards Arakkonam (BG line) and

(III) Southern line towards Chinglepattu

Chennai Central - Gummidipundi (48km, 16 stations) have been running on this line since 1985.

Chennai Central to Arakkonam (69 km, 29 stations) .Beach to Tambaram (30km, 18 stations) is the Chennai suburban system.

Apart from the above, a Rapid Transit System (RTS) on north-south corridor along Buckingham Canal alignment from Chennai Beach to Velachery also exists.

The Rapid Transit System from Chennai Beach to Velachery with a route length of 20 kms is designed as Broad Gauge Double Line with 25 kV AC Traction and with conventional EMU trains. The extension from Velachery to St. Thomas mount is sanctioned and is being taken up for execution.



### **Urban Transport Issues**

It is envisaged that by the year 2026, the population within the Chennai Metropolitan Area (CMA) will be approximately 12.6 million. This would translate into an estimated 17.3 million daily vehicle-trips in the year 2026, which will be about two times the present vehicle-trips. Motor vehicle population has increased at a phenomenal rate during the last few decades. Total vehicle population has increased to 56.14 lakhs (2015). Growth trend in vehicle acute shortage of parking supply is witnessed in commercial areas of Anna Salai, Periyar EVR Salai, T. Nagar, Purasawalkam, George Town, Nungambakkam, Adyar and Mylapore.

The haphazard parking has led to loss in the road capacity that ranges between 15% to 65%. The parking Index which is the ratio of peak parking demand to the supply at important locations The Chennai Metropolis is expected to become one of the Mega Cities in the world with more than 10 million population, in the next 10 years. The Chennai City Corporation with 176 sq.km area will accommodate about 59 lakh population while the rest of the Metropolitan Area with an extent of 1013 sq.km will accommodate about 67 lakh population by 2026 as indicated here under:

In spite of having committed schemes (from Second Master Plan) like MRTS, Metro rail, Suburban rail, Bypass road, Outer Ring Road, Elevated freight corridor etc., Chennai is expected to face severe traffic congestion in the coming years. The rapid economic growth will result in significant increase in traffic management problems. In the absence of properly planned mass transit systems, a disproportionately high share of trips will be carried by personalized modes of transport creating chaotic situation and causing over-strain on the existing infrastructure. To improve the situation, there is a dire need to come up with a comprehensive transportation management plan.

### **Population and Vehicular Growth**

The increase in travel demand with population and vehicular growth, declining share of public transport, with considerably enhanced reliance on the personal motor vehicle has led to increased costs due to travel delays, loss of productivity, deteriorating air quality caused by automobile exhausts and an increased incidence of road accidents. While these are the problems of today, tomorrow's picture is more worrying. Chennai Metropolitan Area's increase in overall growth will require an adequate and efficient transport system to meet the anticipated population by 2026. Existing transportation problems would get compounded and become chaotic if not adequately addressed. From the future needs apart from mobility corridors and transportation systems, intensive improvements are essential for correcting deficiencies. In the light of these trends, the current study provides optimal solutions,



Focusing on a larger comprehensive thought process and on policy issues on the need to ‘move people –rather than vehicles’. The CCTS, apart from formulating a transport improvement roadmap for Chennai for the future, includes an identified transport investment program containing short, medium and long term projects.

The broad objectives are given hereunder:

- Suggest policies, long-term strategies and programmes for the improvement of urban transport in Chennai for the horizon year 2026
- Develop an Urban Transport Planning Model using the state-of-the-art modeling technique appropriate to the conditions and planning needs of the study area
- Identify for all modes, a phased programme of appropriate investments and policy proposals up to 2026 through scientific analysis; and also integrate various modes of mass transit systems
- Identify a medium-term investment programme by prioritizing the identified investment proposals
- Suggest financing mechanisms which may include levy of dedicated taxes
- Suggest policies for Unified Metropolitan Transport Authority (UMTA) for Chennai to facilitate proper institutional mechanism
- Help strengthen the transport planning skills and transfer data/tools/knowledge obtained through the study to CMDA and other agencies.

<b>Population</b>	<b>2008</b>	<b>2026</b>
CITY	4746766	5855332
CMA	3520165	6726333
TOTAL	8266930	12,582,137

**Population**

It is estimated that CMA would house a population of 126 lakhs by 2026, of which Chennai City alone would account for 58 lakhs. The population projection of CMA is presented in Table below. In order to realize the vision of Chennai Master Plan 2026 in making Chennai more livable and economically vibrant the following strategies are proposed in respect of this sector:

To increase overall density of the Chennai Metropolitan Area from the present 59 persons per hectare to 105 persons per hect.; while doing so the density of Chennai will increase from 247 persons per hect. In 2001 to 333 persons per hect. In 2026, while in the rest of CMA the average density will go up from the present 27 persons per hect to 67 persons per hectare.

- To encourage high rise development along wider roads and larger plots; to allow multi-storeyed buildings in the rest of CMA also in order to have planned development with large open spaces on ground to allow higher FSI along the MRTS influence areas for residential developments with smaller dwelling sizes.





- To consider extension of the Transfer of Development Rights concept for lands taken over for development to solve problems of land acquisition for housing and infrastructure. Earmark adequate areas in the plan for employment generating activities.
- To provide better infrastructure facilities like roads, water supply, sewerage, etc. and provide better connectivity through rail and road transport network to the areas identified for development.
- To encourage development of Thiruvallur and Gummidipoondi as satellite towns as envisaged in the FMP by provision of adequate infrastructure like housing and other developments and providing better housing facilities at affordable cost; to develop new towns/ neighbourhoods near Tiruporur in the southern corridor along Rajiv Gandhi Salai and near Sriperumbudur, in the western corridor along GWT Road.
- To take up housing development near Mahindra Park SEZ either by provision of plots or by regulating layout development by private entrepreneurs.
- To encourage green building concept and provide special facilities to take care of the needs of the elderly persons whose population is likely to go up, e.g. more old age homes, low-floor buses, special seats in buses, special seats in toilets and ramps in public buildings.
- To provide for preservation and conservation of ecologically sensitive areas in CMA and to create more parks and playgrounds for recreation purposes.
- To encourage social housing provision by private developers of large group developments / multi-storeyed developments through Development Regulations.
- To encourage LIG housing by allowing additional FSI of 0.25 to private developers for such developments.

**Projected Population**

<b>Projected Population for CMA and Chennai City (In Lakhs):</b>									
No.	Description	Actual			Projection			Gross Density (Persons Hectare)	
		2001	2006	2011	2016	2021	2026		
		2001	2006	2011	2016	2021	2026	2026	
1	Chennai City	43.44	46.28	49.5	52.39	55.4	58.56	333	
2	Municipalities	15.81	18.52	21.75	25.6	30.2	35.69	149	
3	Town Panchayats	3.86	4.73	5.89	7.41	9.45	12.22	78	
4	Village Panchayats	7.31	8.7	10.59	12.96	15.99	19.88	32	
	CMA [Total]	70.41	78.96	88.71	99.66	111.97	125.82	105	



## **Economy**

Chennai is a major transportation hub for road, rail, air and sea transport connecting major cities inland and abroad. Chennai is one of the major educational centres in India with a number of colleges and research institutions. Recently it has also been emerging as an important health centre with a large number of super specialty hospitals.

Chennai has become one of the preferred destinations for IT / ITES companies. Tamil Nadu is the second largest software exporter in the country, and 90% of the export is from Chennai alone. A large number of IT / ITES developments are located along the Rajiv Gandhi Salai (OMR), the area popularly known as IT Corridor.

Chennai has also emerged as a major export hub in the South East Asia. International car manufacturers such as Ford, Hyundai, and General Motor etc. have established around Chennai their manufacturing bases to cater to domestic and international markets.

Chennai has a diversified economic base anchored by the automobile, software services, hardware manufacturing, health care and financial services industries. According to the Confederation of Indian Industry, Chennai is estimated to grow to a US\$100–billion economy, 2.5 times its present size, by the year 2026.

### **Land Use Density & FSI**

Chennai is one of the high-density cities in India. Its density varies from 180 persons per hec. in Saidapet and Mylapore Corporation zones and 368 persons per hec. in Kodambakkam zone within the Corporation limits and the gross density for Chennai City is 247 persons per hec. FSI is the main tool used in urban planning to regulate the densities of population with reference to infrastructure provision. Density of population needs to be regulated for various reasons including carrying capacity of infrastructure (existing as well as proposed), sociological reasons such as crime rate etc and other physical factors.

The existing developments in Chennai can be categorized as high dense medium raised developments mostly of buildings up to 15 m. heights. FSI allowed for such development up to 15 m. height presently is maximum 1.5. Multi stroeyed developments (high rise development) within CMA are very few; in order to encourage amalgamation of smaller plots into larger size and construction of buildings with large open space around, a higher FSI of 2.5/2.75 is allowed in multistoreyed developments.

The practice of increasing FSI under the disguise of high land cost needs to be discouraged. At the same time allowing higher FSI in the suburbs and lower FSI in central areas of the City also needs very careful consideration considering the carrying capacity of infrastructure, impact on environment including ground water and traffic volumes.



<b>Projected Daily Trips By Public Transport</b>		1991	2004	2006	2011	2016	2021	2026	
1. Population in lakh		58.07	75.61	78.96	88.71	99.62	111.98	125.82	
2. Daily per capita Trips		1.29	1.32	1.34	1.5	1.6	1.6	1.65	
3. Total Daily Person Trips in lakh		74.91	99.81	105.81	133.07	159.39	179.17	207.60	
Scenario 1 Modal Split %	Private	57	64.57	60.00	50	45	40	35	
	Public	43	35.43	40.00	50	55	60	65	
Total Daily Person Trips by Public Transport in lakh		32.21	35.36	42.32	66.53	87.67	107.50	134.94	
		By Rail %	9.25	14.54	16.00	20	25	30	25
		By Road%	90.75	85.46	84.00	80	75	70	75
Daily Trips in lakhs	By Rail	2.98	5.14	6.77	13.31	21.92	32.25	33.74	
	By Road	29.23	30.22	35.55	53.23	65.75	75.25	101.21	
Scenario 2 Modal Split %	Private	57	64.57	55.00	45	40	35	30	
	Public	43	35.43	45.00	55	60	65	70	
Total Daily Person Trips by Public Transport in lakh		32.21	35.36	47.61	73.19	95.64	116.46	145.32	
		By Rail %	9.25	14.54	16.00	20	25	30	25
		By Road %	90.75	85.46	84.00	80	75	70	75
Daily Trips in lakh	By Rail	2.98	5.14	6.77	13.31	21.92	32.25	33.74	
	By Road	29.23	30.22	35.55	53.23	65.75	75.25	101.21	
Scenario 3 Modal Split %	Private	57	64.57	55.00	45	40	35	30	
	Public	43	35.43	50.00	60	65	70	75	
Total Daily person Trips by Public Transport in lakh		32.21	35.36	52.90	79.84	103.60	125.42	155.70	
		By Rail %	9.25	14.54	20.00	30	35	40	45
		By Road %	90.75	85.46	80.00	70	65	60	55
Daily Trips in lakhs	By Rail	2.98	5.14	10.58	23.95	36.26	50.17	70.07	
	By Road	29.23	30.22	42.32	55.89	67.34	75.25	85.64	

Source: CTTS (MMDA, RITES, KCL & PTCS, 1992-95) & Short term study to update CTTS (1992-95)(CMDA, RITES & PTCS, 2004)

The Study provided the core inputs for predicting the future travel demand for the CMA. The travel demands in 2004, 2006, 2011, 2016, 2021 & 2026 have been projected on the basis of increase in per capita trips (from 1.32 in 2004 to 1.6 by 2016 and 1.65 by 2026). Table no. 5.01 gives 3 scenarios based on different modal splits between the road and rail system. The 3 scenarios have been worked out gradually increasing the share of the public transport between the public and private transport modes and also increasing the share of the rail transport between the bus and rail modes. Scenario 2 has been selected based on the following assumptions.



- i) The modal split between public and private transport will change from 43:57 to 35:65 (2004), 55:45 (2011) and 60:40 (2016), 65:35 (2021) and 70:30 (2026) in line with the trend in share of public transport increasing with City size.
- ii) The sub-modal split between bus and rail will have to change from 91:9 to 85:15 (2004), 75:25 (2011), 70:30 (2016), 65:35 (2021) and 60:40 (2026) if the road transport system is not to break down in the context of increased commuter trips.

### **Strategies – Traffic & Transportation**

The shelf of urban transport infrastructure projects, based on various studies, incorporated in the draft Master Plan II, has been publicly disclosed. A quick review of the shelf of projects, indicate that the targeted modal share of 70% by public transport is fairly realizable provided the metro rail network is implemented in full and the road network expanded by development of elevated highways.

The total person trips by motorised vehicles constituted 54.5% of all person trips made in the CMA in 2005 the target of 70% of these trips by the public transport (i.e 38.15% of all person trips by motorised vehicles) by 2026 works out to 7.9m trips / day. With the implementation of 46km of Metro rail which would carry not less than 0.4m trips / day, the MRTS together with the sub-urban network 0.8m trips / day and the MTC with the expanded fleet size of not less than 6000 and a network of BRT carrying about 7.0m trips / day, the target is fairly achievable (even though the rail transit is expected to carry as much as 6 m trips / day).As for the remaining person trips by motorised vehicles (i.e 30% of all person trips by motorised vehicles) works out to 3.4m trips per day by 2026. Implementation of the network of elevated highways, the network of BRT and the series of debottlenecking measures viz. underpasses / overpasses, flyovers, etc proposed in the shelf would assist in coping with these many trips by private vehicles.

### **Recommendations and Way Forward**

Chennai has one of the highest densities in the INDIA. The gross density in the urban areas has increased from 5,553 persons per sq km in 1991 to 7,037 persons per sq km in 2001. The increase in density is mostly due to natural increase and due to migration from nearby villages. The population density in municipal limits is 11,303 persons per sq km, which has now reached the saturation level. In future the population is expected to grow more in the outer areas gives the population density in Chennai urban area.



**Proposed Land Use Plan – 2026**

Proposed Land Use Plan – 2026				
	Chennai City		Rest of CMA	
	Extent in Hectares %		Extent in Hectares %	
Primary Residential use zone	5916.35	33.58%	32090.68	31.68%
Mixed Residential use zone	2426.9	13.78%	13503.1	13.34%
Commercial use zone	714.24	4.05%	880.35	0.86%
Institutional use zone	2868.97	16.28%	3888.85	3.83%
Industrial use zone	691.83	3.93%	7274.3	7.18%
Hazardous Industrial use zone	130.67	0.74%	3416.08	3.38%
Open Space & Recreational use zone	1000.65	5.68%	392.86	0.38%
Agriculture use zone			7295.81	7.20%
Non Urban	113.31	0.64%	2332.92	2.30%
Urbanisable hills			2075.89	2.05%
Others (Roads, water bodies, hills, Redhills catchments area, forests etc.,)	3754.79	21.31%	28147.55	27.79%
<b>Total</b>	<b>17617.7</b>	<b>100.00%</b>	<b>101298</b>	<b>100.00%</b>

**Growth of Travel Demand in CMA**

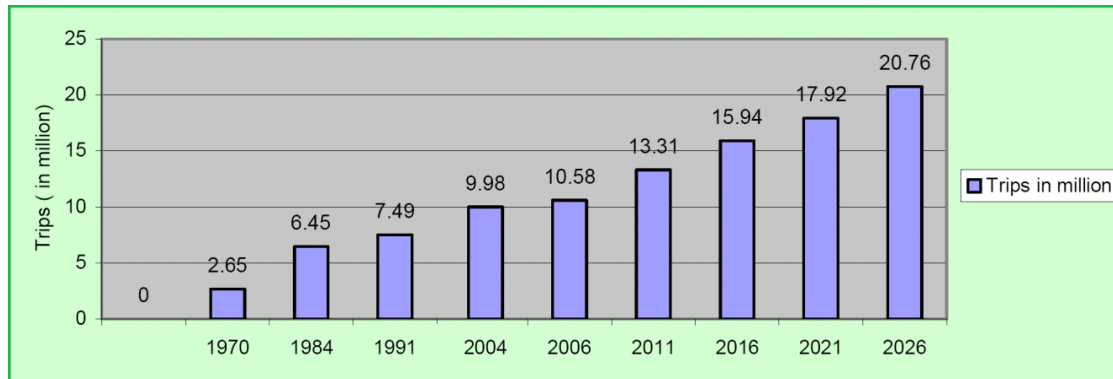

**Traffic & Transportation 2026**

Growth of Travel Demand (in lakhs)	2004	2026
Total Mass Transport Trips	35.36	145.09
Increase in 22 years	–	109.73
Total road (bus trips)	30.22	87.05
Increase in 22 years	–	56.83
Total rail trips	5.14	58.04
Increase in 22 years	–	52.9





Ward Wise Population Projection

Ward Wise Population Projection												Assumed Ward Growth	
Guidance: Yellow cells are to be suitably filled													
Ward No.	Area in hectare	Population 2001	Density 2001	Projected Population				Projected Population				Population Density	% Decadal Increase
				2011	2021	2031	2041	2011	2021	2031	2041		
1	275.75	12766	46.29	55.55	66.66	80.00	96.00	15319	18383	22060	26472	0-100	20.00%
2	62.67	9999	159.54	188.26	222.15	262.13	309.32	11799	13923	16429	19386	100-200	18.00%
3	9.71	6185	636.65	662.12	688.60	716.15	744.79	6432	6690	6957	7236	200-300	15.00%
4	109.22	8078	73.96	88.76	106.51	127.81	153.37	9694	11632	13959	16751	300-400	12.00%
5	22.78	5528	242.72	279.13	321.00	369.15	424.52	6357	7311	8407	9669	400-500	9.00%
6	293.40	14882	50.72	60.87	73.04	87.65	105.18	17858	21430	25716	30859	500-600	6.00%
7	157.11	20857	132.75	156.65	184.84	218.11	257.37	24611	29041	34269	40437	600-700	4.00%
8	26.32	7729	293.61	337.65	388.29	446.54	513.52	8888	10222	11755	13518	700-800	2.00%
9	13.37	5813	434.67	473.79	516.43	562.91	613.57	6336	6906	7528	8206		
10	22.38	7122	318.25	356.44	399.22	447.12	500.78	7977	8934	10006	11207		
11	68.36	11061	161.82	190.94	225.31	265.87	313.72	13052	15401	18174	21445	Assumed Maximum Dencity	800 persons/hactare
12	10.38	5852	563.95	597.79	633.66	671.68	711.98	6203	6575	6970	7388		
13	25.33	5002	197.47	227.09	261.16	300.33	345.38	5752	6615	7607	8749		
14	10.05	7253	721.62	736.06	750.78	765.79	781.11	7398	7546	7697	7851		
15	66.12	15563	235.38	270.69	311.29	357.99	411.68	17897	20582	23669	27220		
16	6.08	5140	844.99	800.00	801.00	802.00	803.00	4866	4872	4878	4885		
17	8.84	3438	388.96	435.63	487.91	546.46	612.03	3851	4313	4830	5410		
18	16.34	4745	290.47	334.04	384.14	441.76	508.03	5457	6275	7217	8299		
19	19.72	5671	287.56	330.70	380.30	437.35	502.95	6522	7500	8625	9919		
20	9.18	8713	949.50	800.00	800.00	800.00	800.00	7341	7341	7341	7341		
21	4.13	4798	1162.64	800.00	800.00	800.00	800.00	3301	3301	3301	3301		
22	28.95	4396	151.85	179.18	211.43	249.49	294.40	5187	6121	7223	8523		
23	48.33	6893	142.61	168.28	198.57	234.31	276.49	8134	9598	11325	13364		
24	33.46	5527	165.18	194.91	229.99	271.39	320.24	6522	7696	9081	10716		
25	33.31	7638	229.30	263.70	303.25	348.74	401.05	8784	10101	11616	13359		
26	7.92	5780	730.24	744.84	759.74	774.93	790.43	5896	6014	6134	6256		
27	14.39	5554	385.89	432.19	484.05	542.14	607.20	6220	6967	7803	8739		
HMC	1403.60	211983	151.03	169.3	193.3	221.3	254	237655	271291	310577	356502		
Outer Area	3229.4			12.54	29.01	52.12	84.18	40493	93675	168304	271850		
Total	4633						135.6	278148	364966	478881	628352		



Sl.	No.	Location Name	Peak Pedestrian Counting Numbers Hour	Total Count 12 Hrs
1		Aminjikarai Market Junction	3299	18966
2		Anna Nagar 2nd Avenue	2183	15372
3		Anna Salai near SIET College	3280	22241
4		Arcot Road near Meenakshi College	2434	18038
5		Arcot Road near Vadapalani Bus stand	3674	16543
6		Arcot Road Vs Jawaharlal Nehru Road	4369	31982
7		Broadway	10037	75665
8		Light House	913	6975
9		Doveton	2547	21943
10		Egmore Railway Station	4686	37224
11		In front of Parambur Bus Stand	2040	16939
12		Jawaharlal Nehru Road in front of central Mofussil Bus Terminus	1233	7849
13		Kamaraj Salai near Queen Mary's College	1058	4272
14		Kathipara Junction	2731	24992
15		Koyambedu Junction	1652	13645
16		Lattice Bridge Road near Thiruvanmiyur Bus Stand Junction	8631	47957
17		Luz Intersection	3777	26401
18		Periyar EVR Salai Vs Mint Street	6733	55782
19		Periyar EVR Salai Vs New Avadi Road	1110	9071
20		Periyar EVR Salai Vs Taylors Road	1566	10475
21		Periyar EVR Salai Vs E.V.K.Sampath Road	899	7402
22		In front of Raja Annamalai Mandram	2055	21025
23		Rattan Bazaar - Evening Bazaar Road Intersection	13888	128008
24		Royapettah High Road Vs Dr.Radhakrishnan Salai	1281	9396
25		Sardar Patel Road Vs Velachery Main Road	900	6860
26		Sterling Road Vs College Road	1031	7242
27		T.T.K. Road Vs Cathedral Road	569	4852
28		Tollgate near Thiruvottriyur	3215	24890
29		South Usman Road Vs Duraiswamy Road	9346	63007
30		South Usman Road In front of T. Nagar Bus Stand	11518	83074
31		Taramani Velachery Road Vs Velachery Main Road	3660	24803
32		Taramani Velachery Road Vs Velachery Bypass Road	5834	39027
33		Thiruvottriyur High Road near Wimco Nagar Railway Station	1362	10839
34		Poonamallee Trunk Road Vs Avadi Road Junction	699	3897
35		Arcot Road at Porur Junction	5622	34770
36		CTH Road in front of Ambattur Estate Bus Stand	3388	21227
37		CTH Road in front of Ambattur Bus Stand	3634	18876
38		CTH Road near Avadi Bus Stand	5613	41122
39		GST Road near Pallavaram Bus stand	3875	33008
40		GST Road near Tambaram Bus Stand	4179	34486
41		GST Road near Chromepet Bus stand	4781	31328
42		Kathivakkam High Road near Ennore Railway Station	870	6499
43		Mount Poonamallee Road in front of Iyyapanthangal Bus Stand	1254	7016
44		Mount Poonamallee Road Vs Mangadu Road Junction	4264	33298
45		Poonamallee High Road near Maduravoyal Market	1103	7182
46		Poonamallee High Road Vs Thiruverkadu Road Junction	880	7097
47		Thiruvottriyur Bus Stand Junction	2337	16139



**Peak Hour Traffic at Screen Line Locations**

No	Location	Peak hour PCU	Daily PCU	Peak Hour Factor (Peak PCU/Daily PCU) (%)
1	Durgabhai Deshmukh Road near Sathya Studio	11061	139633	7.9
2	Gandhi Mandapam Road near Adyar Villa	7039	86659	8.1
3	Anna Salai at Saidapet Maraimalai Adigal Bridge	13640	186419	7.3
4	Alandur Bridge near Guindy Industrial Estate	1096	14281	7.7
5	J.Nehru Road Crossing Adyar River near Ekkattuthangal	7429	116161	6.4
6	Kamaraj Salai at Napier Bridge	8548	96375	8.9
7	Anna Salai near Chindadripet Railway Station	8048	99413	8.1
8	Arunachala Street at St Andrew's Bridge	2,773	39264	7.0
9	Adithanar Road at Harris Bridge	7635	83149	9.2
10	Binny Road near Quaid -e- Millath College	8051	99735	8.1
11	Pantheon Road near Co- Optex	10070	109720	9.2
12	Mc Nichols Road crossing Cooum River	10750	146440	7.3
13	Harrington Road crossing Cooum River	2893	35287	8.2
14	Periyar EVR Salai near Aminjikarai Market	5656	82388	6.9
15	Anna Nagar 3rd Avenue near K3 Police Station	5927	79498	7.5
16	Bridge crossing Cooum River near Anna Adarsh College	2423	27789	8.7
17	Jawaharlal Nehru Road near Koyambedu	7841	107604	7.3
18	Rajaji Salai near Royapuram Railway Station	2050	25202	8.1
19	Mannarswamy Koil Street near Chetty Thottam	5351	73632	7.3
20	Monegar Choultry Road behind Stanley Medical college	1,644	20917	7.9
21	Thiruvottriyur High Road near Washermanpet Railway Station	5356	65335	8.2
22	Kathivakkam High Road near Harinarayanapuram Post office	2,610	30440	8.6
23	Erukanchery High Road near Venkateshapuram	4438	62126	7.1
24	Perambur Road near Vyasarpadi Jeeva Railway Station	5,072	64683	7.8
25	Perambur High road near Perambur Railway Station	4516	66751	6.8
26	Perambur Loco Works I near Jawahar Nagar	2337	26529	8.8
27	Perambur Loco Works II near Jawahar Nagar	2041	29052	7.0
29	TVS junction on Jawaharlal Nehru road	4276	56846	7.5
30	CTH Road near Agathiar Nagar	7294	111236	6.6
31	Nelson Manickam Road near Nungambakkam Railway Station	9294	118442	7.8
32	NSK Salai near Kodambakkam Railway Station	7970	105447	7.6
34	Duraiswamy Road subway	7091	89997	7.9
35	Madley Road Subway	5268	61611	8.5
36	Aranganathan Road Subway	5083	63154	8.0
37	Saidapet Market Road subway	5211	54965	9.5
38	Mount Poonamallee Road near MIOT Hospital	5131	80279	6.4
39	Causeway at Cowl Bazaar Road	339	4293	7.9
40	Bridge at Pammal Kunrathur Road	1572	19087	8.2
41	Golden George Rathnam Salai near Nerkundram	1692	20670	8.2
42	Causeway near MGR Engineering College	2169	26095	8.3
43	Bridge at Vanagaram - Ambattur Road	2336	29243	8.0
44	Thiruverkadu Causeway	1206	15406	7.8
45	Bridge at Avadi- Poonamallee Road	2,551	38719	6.6





**Rajiv Gandhi Salai** (also known as **Old Mahabalipuram Road (OMR)** or **IT Corridor**) is a major road in suburban Chennai, India, beginning at the Madhya Kailashtemple in Adyar in South Chennai and continuing south till Mahabalipuram in Kanchipuram district, ultimately merging with the East Coast Road. This is popularly called as the 'IT Corridor' because this stretch has become home to many IT/ITES companies. This road is State highway-49A.

### ***Project Implementation***

The IT Corridor Project, is an initiative of Government of Tamil Nadu to develop the Corridor as a world-class facility and to promote a progressive and IT/ITES friendly image of Tamil Nadu. TNRDC has incorporated a special purpose organization called 'IT Expressway Ltd' (ITEL) as a wholly owned subsidiary, for domiciling the IT Corridor Project. ITEL is an investment vehicle and the TNRDC is its Managing Associate. It is responsible for project implementation and operations and maintenance of the IT Corridor.

### ***Project Phases***

The IT Corridor Project is being implemented in two phases – Phase-I(20 km) between Madhya Kailash Temple Junction and Siruseri, and Phase-II(26 km) between Siruseri and Mahabalipuram. The 2.1 km long ECR Link Road connecting IT Corridor at Sholinganallur and East Coast Road at Kudumiyandithoppu is also included in Phase-I. As part of the Phase-II, two bypasses would be provided in Kelambakkam and Thiruporur. With the commissioning of Phase I, the travel time from Madhya Kailash to Siruseri has been reduced by half an hour.





## **Project Features**

The entire stretch will be built as 6 lane road with additional service roads and footpaths on the sides. In phase-I, the total right of way is 41 metres and the footpaths will be built over the ducts for sewerage, drainage and other service lines. This space constraint was one of the reason Phase-I works got delayed. TNRDC has proposed to keep the width of the second phase at 60 metres. The additional land is planned for separate space for pavements and ducts to enable the simultaneous development of work for ducts and pavements unlike in Phase-I.

## **Phase-I**

Though the IT expressway was to have been fully operationalised by March 2005, the road works ran into rough weather and suffered undue delay due to contractual problems and other issues, including shifting of service utility facilities and land acquisition. The actual inauguration of the six-lane main carriageway - and the 2.1 km link road connecting the IT corridor and ECR - happened on 29th Oct 2008. Starting 14th Dec 2008, TNRDC has started collecting toll, for phase-I of Rajiv Gandhi Salai (from Madhya Kailash junction to Siruseri). However (as per official acknowledgement), as of Feb 2009, the phase-I construction work is still not complete in all aspects - including work on service roads, footpaths and drains. As of Apr-2010, Service roads and footpaths along the IT Corridor are available for three km from Madhya Kailash to the SRP Tools junction. There had been no progress on the work on the remaining stretch, including the setting up of busbays, from previous six months (from Nov-2009 till May-2010).

**Phase-II** Acquisition of 156 hectares of land in 13 revenue villages, required for phase-II, is being done by the Kancheepuram district administration and was initially expected to be completed by the end of 2010.[9] However, the project was delayed and, it was only in 2011 that the state government decided to start works on the 25-km stretch from Siruseri to Mahabalipuram which will be taken up under viable financial format through the public private partnership model at a rough cost of ₹ 5,500 million. The land acquisition exercise costs ₹ 700 million.





In 2012, the state government sanctioned ₹ 2,600 million towards land acquisition for the widening of the second phase of the project. The project envisages widening the four-lane stretch with a median to a six-laned one. Phase II covers a 26.8-km stretch, which is under the charge of the State Highways Department, runs from Siruseri to Poonjeri, where it will join the East Coast Road. Two new by-passes have been planned to avoid urbanised areas with several buildings. The road will run through 13 revenue villages and nearly 200 acres of land are required to widen it. One by-pass, running to a length of 4.67 km, will come up in Padur and reach Thaiyyur-B village, by-passing Kelambakkam. Similarly, the other by-pass of 5.75 km will take off in Kalavakkam and join Vengaleri. It will by-pass Thiruporur and Thandalam. Widening the road to six lanes and strengthening it is imperative, as a lot of development is taking place beyond Siruseri, which has a SIPCOT park. A large number of residential complexes and several colleges too have come up to Thiruporur, which also witnesses a high volume of traffic.

### ***Project Cost and Rol***

Protracted delays led to a tripling of costs in the first phase - from Rs 130 crore to more than Rs 400 crore - and have hit the viability of the project. The impact of the cost escalation in the first phase means TNRDC will be unable to recover the project cost from the toll collections. The monthly revenue of Rs 2 crore from over 26,000 vehicles that use this stretch daily is barely enough to cover the interest costs and operation and maintenance of the road. Return on investment is unlikely

### ***OMR near kasturibhai nagar***

The initial estimates for the second phase also have almost doubled to approx. Rs. 550 crores from the Rs. 280 crores estimated during the earlier feasibility study.

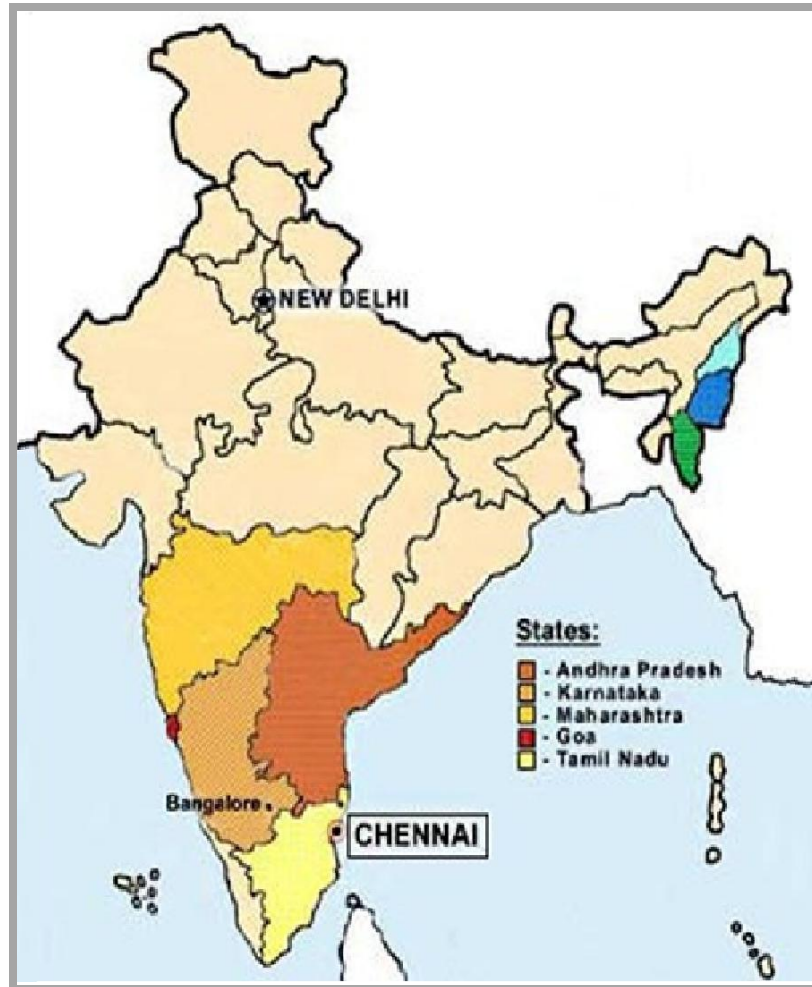

**The Location of Chennai in India**

### ***Chennai's Population & Governance***

Chennai, formerly known as Madras, is the capital city of the Indian state of Tamil Nadu on the Coromandel Coast of the Bay of Bengal. Chennai is the fourth largest Metropolitan City in India<sup>3</sup>. The Chennai Metropolitan Area (CMA) comprises the city of Chennai, 16 Municipalities, 20 Town Panchayats and 214 Village Panchayats in 10 Panchayat Unions. . As of 2009, Chennai city had a population of 6.6 million<sup>4</sup>, and the CMA has an estimated population of over 7.6 million<sup>5</sup>. The CMA's population has increased rapidly from 4.50 million in 1981 to 7.06 million in 2001, and has now reached 7.60 million<sup>6</sup>. The population density of the CMA is 24,000 people/square km<sup>7</sup>



## 9 - STATION

Operating plan "MTC TRANS" stations are planned to be located **Mamallapuram to Thiruvanmiyur Bus Stand** at 36 internal stations with one depot and main terminal at **Thiruvanmiyur Bus Stand**.

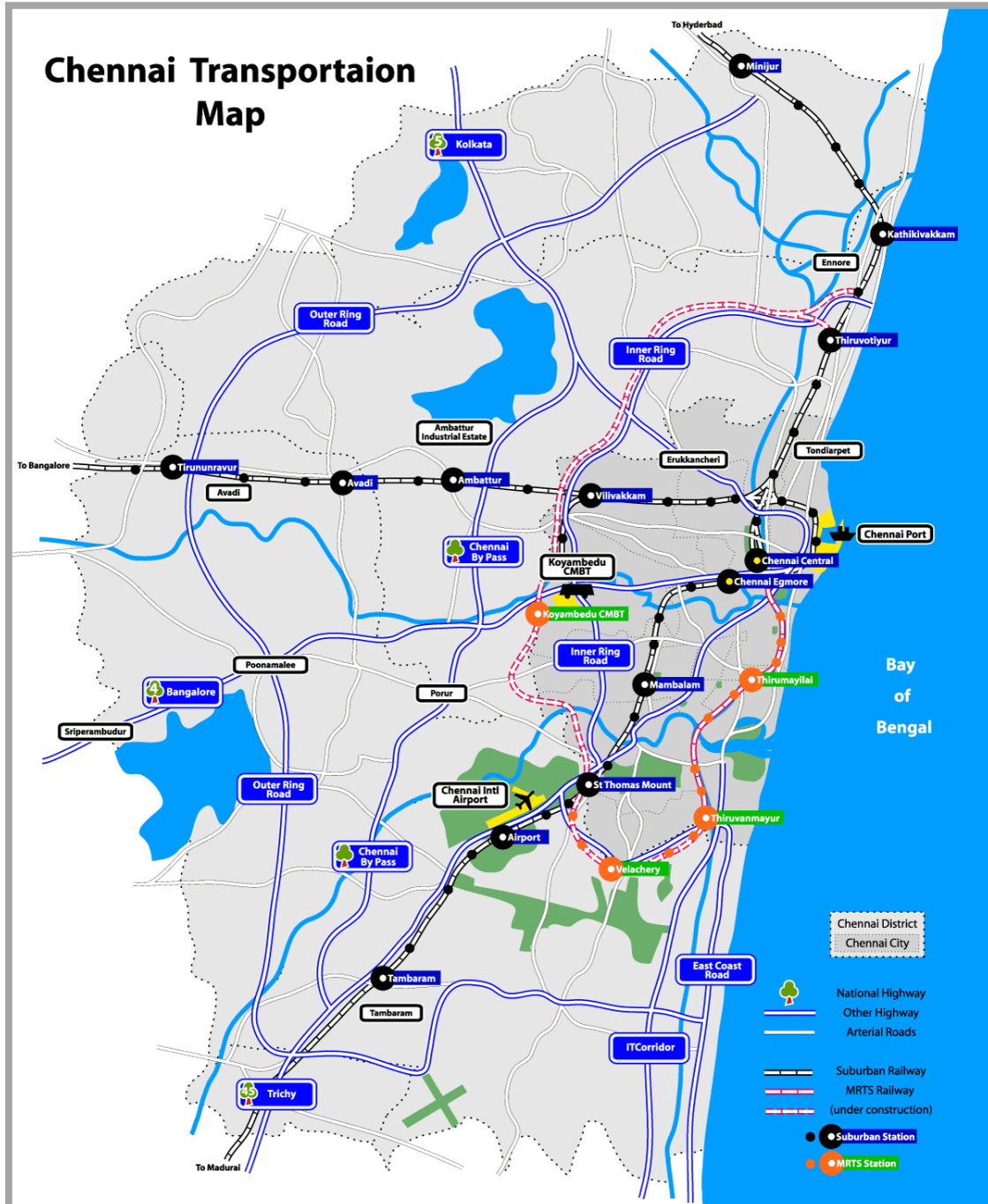





**The MTC TRANS service locations of the Target projects are as indicated**

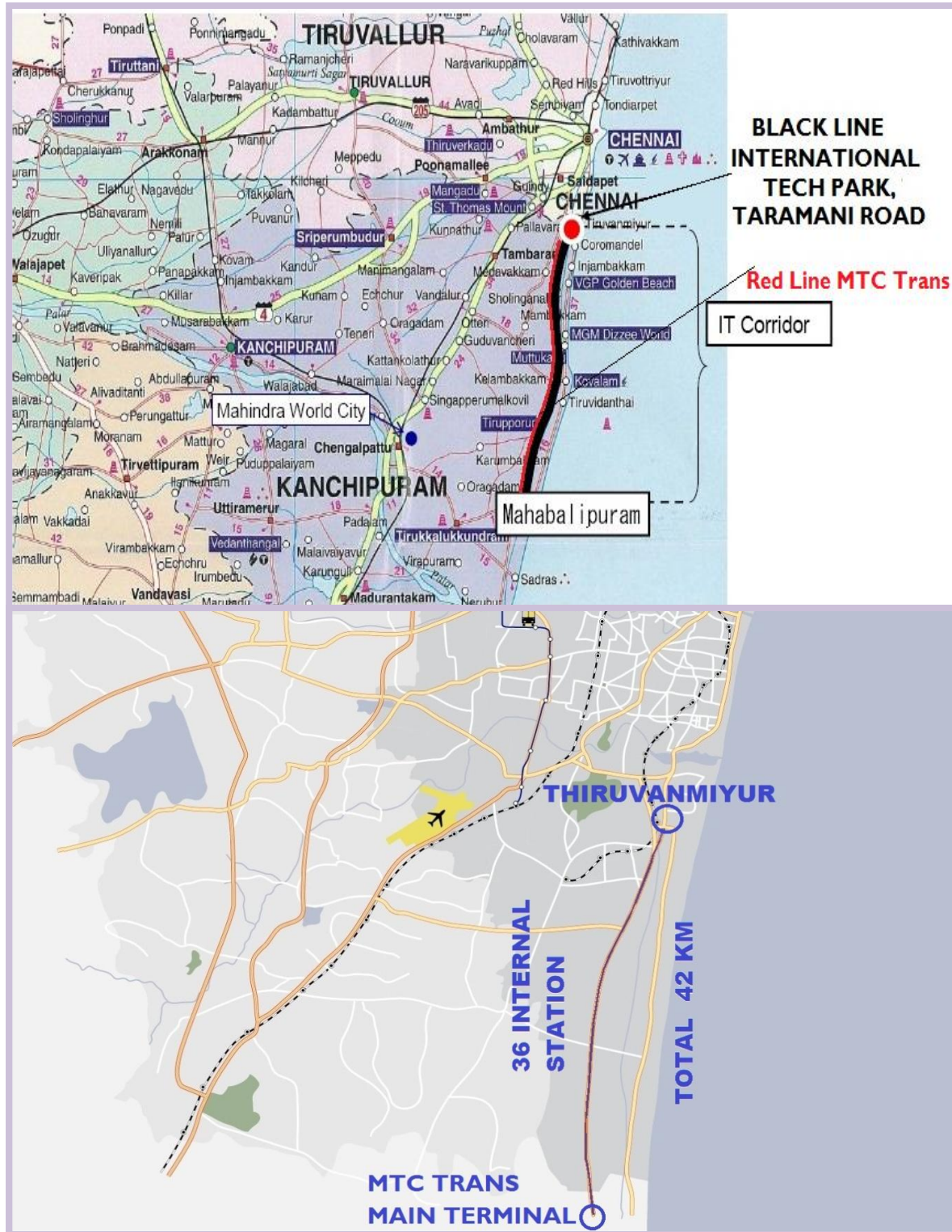



### MTC TRANS 36 Station 42 Km Marking Plan

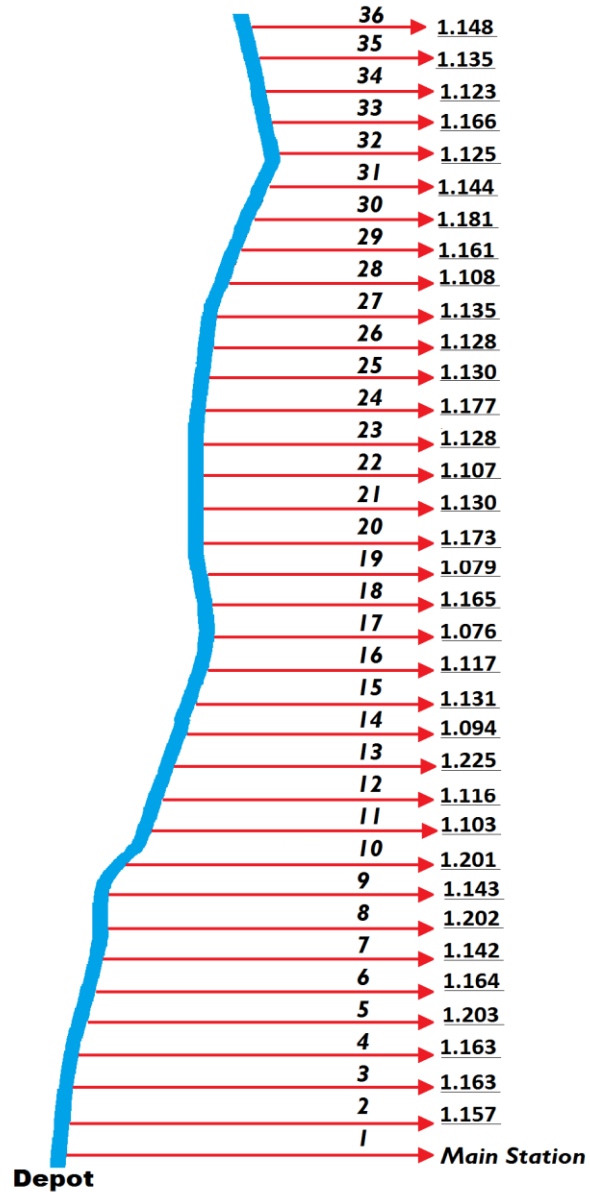
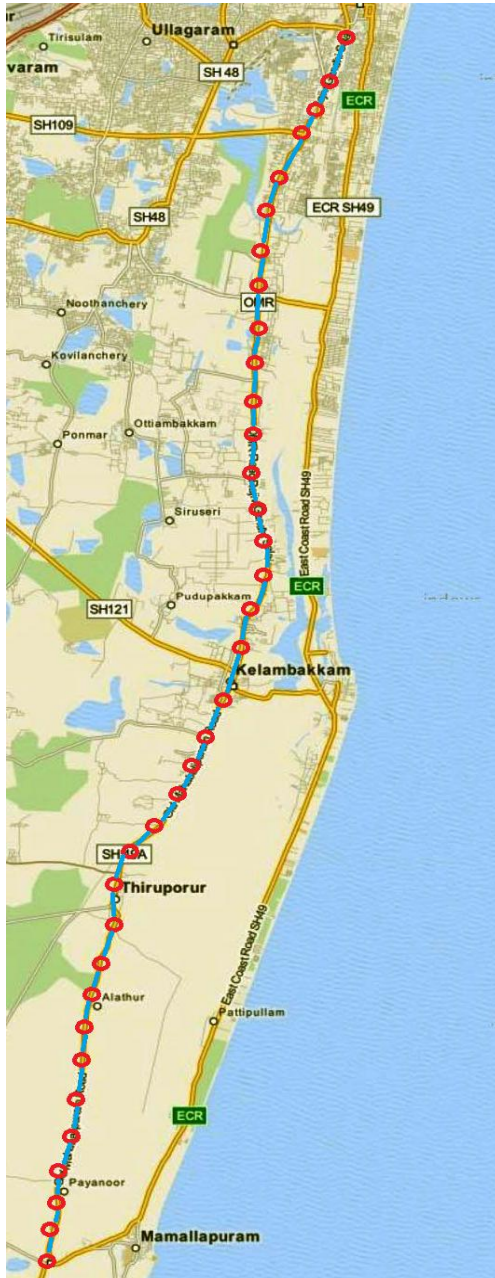

36 STATION 42KM

Alignment Chennai MTC TRANS Route Map





**Chennai Railway Network & Bus Interconnectivity and MTC TRANS connectivity Map**

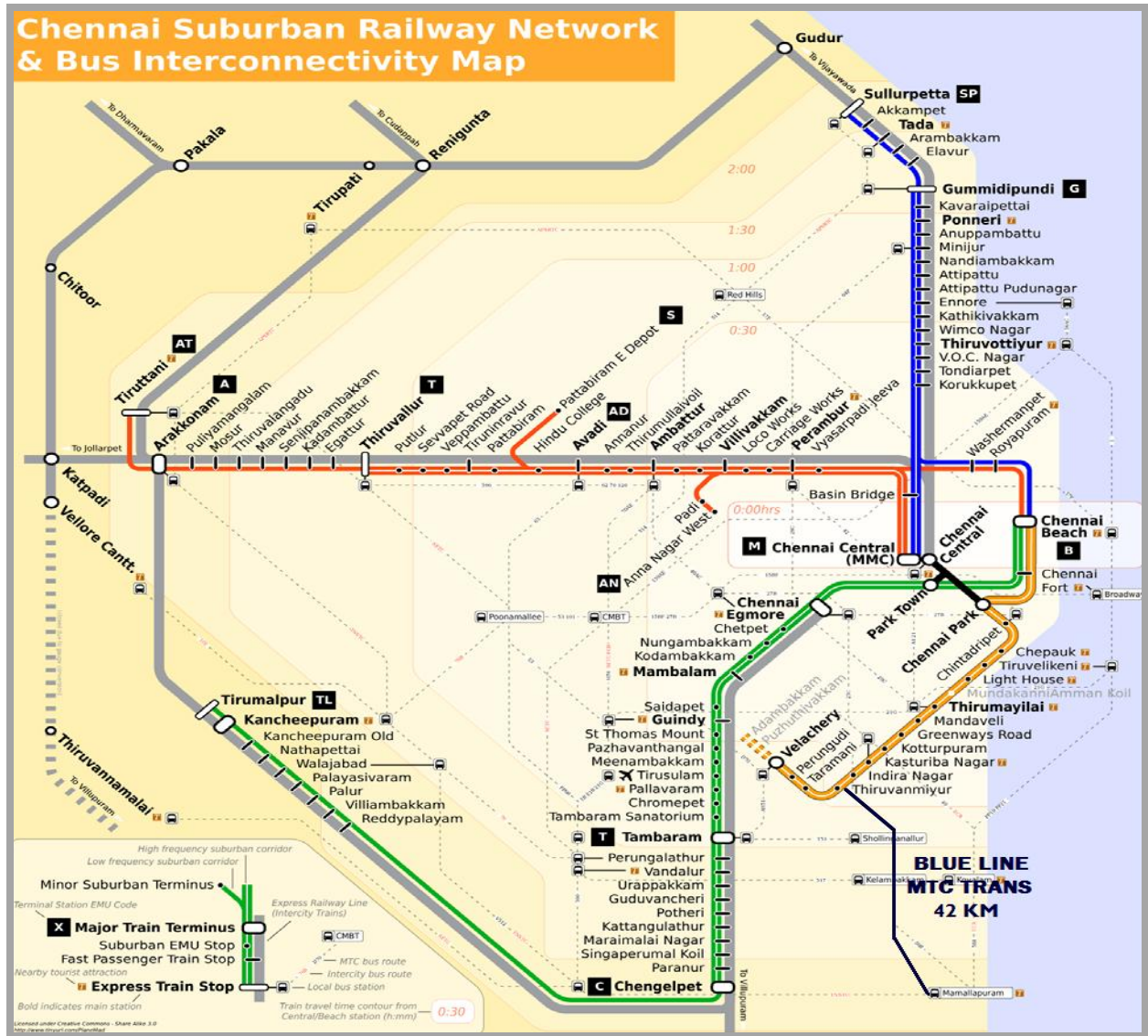

The Chennai city is lined with a number of software parks, the most famous among them being the Tidel Park. Major electronics manufacturers such as Dell, Nokia, and Samsung have their Indian manufacturing bases in the city. Car manufacturers like FORD, Renault-Nissan and Hyundai have established their base in and around Chennai; Ashok Leyland-Bus manufacturer is also based out of Chennai. In the financial services sector, renowned financial institutions like the World Bank, HSBC, and Citibank have back office operations in Chennai. Chennai's software and biotech sector has attracted businesses such as Wipro, Infosys, TCS, HCL, EDS, Accenture, Sun Microsystems and HP.



### MTC TRANS Selection of Corridors

A feasibility study was carried out in 2016 to select and prioritise the corridors for MTC TRANS on detailed traffic surveys, following corridors were recommended:-

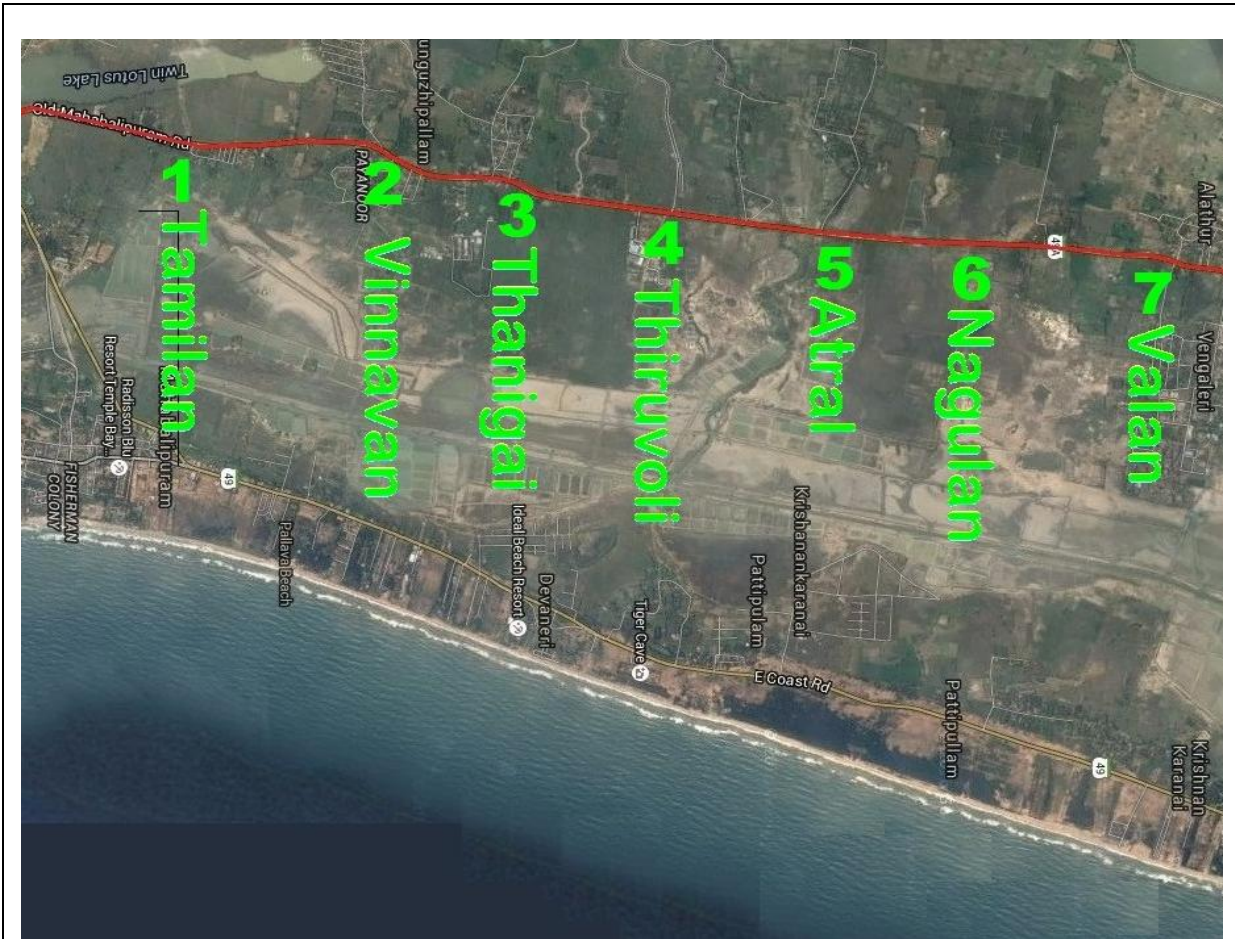

<b>Name of station</b>	<b>Tamilan</b>
Type of station	All Stations Elevated G+1 <sup>st</sup> +2 <sup>nd</sup>
Station location	<b>POONJERI MAIN STATION</b>
<b>Name of station 1</b>	<b>Vinnavan</b>
Station location	<b>Paynoor</b>
Chainage	1157
<b>Name of station 2</b>	<b>Thanigai</b>
Station location	<b>KARUNGUZHIPPALLAM</b>
Chainage	2320
Inter station distance	1163
<b>Name Of Station No 3</b>	<b>Thiruvoli</b>
Station location	<b>PAYNOOR ROAD</b>
Chainage	3483
Inter station distance	1163
<b>Name Of Station No 4</b>	<b>Atrai</b>





Station location	<b>OMEGA CITY</b>
Chainage	4686
Inter station distance	1203
<b>Name Of Station No 5</b>	<b>Nagulan</b>
Station location	<b>THANDALAM-1</b>
Chainage	5850
Inter station distance	1142
<b>Name Of Station No 6</b>	<b>Valan</b>
Station location	<b>THANDALAM-2</b>
Chainage	6992
Inter station distance	1142
<b>Name Of Station No 7</b>	<b>Aalavandan</b>
Station location	<b>THANDALAM-3</b>
Chainage	8194
Inter station distance	1202



<b>Name Of Station No 8</b>	<b>Nambi</b>
Station location	<b>KAKIYAMMAN KOVIL ST</b>
Chainage	9337
Inter station distance	1143
<b>Name Of Station No 9</b>	<b>Gnanam</b>
Station location	<b>THANDALAM ROAD</b>
Chainage	10538



Inter station distance	1201
<b>Name Of Station No 10</b>	<b>Cholan</b>
Station location	ESSER BUNK STOP
Chainage	11641
Inter station distance	1103
<b>Name Of Station No 11</b>	<b>Arul</b>
Station location	THIRUPOUR TEMPLE
Chainage	12757
Inter station distance	1116
<b>Name Of Station No 12</b>	<b>Inban</b>
Station location	KANAGAPATTU
Chainage	13982
Inter station distance	1225
<b>Name Of Station No 13</b>	<b>Pachai</b>
Station location	SSN COLAGE
Chainage	15076
Inter station distance	1094
<b>Name Of Station No 14</b>	<b>Anandam</b>
Station location	SENGANMAL
Chainage	16207
Inter station distance	1131



<b>Name Of Station No 15</b>	<b>Neelan</b>
------------------------------	---------------



Station location	<b>RAMALINGAPURAM</b>
Chainage	17324
Inter station distance	1117
<b>Name of station 16</b>	<b>Lingam</b>
Station location	<b>MADHA KOVIL ST</b>
Chainage	1165
Inter station distance	18400
<b>Name of station 17</b>	<b>Paari</b>
Station location	<b>PADUR ROAD</b>
Chainage	19565
Inter station distance	1165
<b>Name of station 18</b>	<b>Ponnadi</b>
Station location	<b>PADUR ANGALAMMAN KOVIL</b>
Chainage	20644
Inter station distance	1079
<b>Name Of Station No 19</b>	<b>Chemmal</b>
Station location	<b>KANNATHUR REDDY KUPPAM</b>
Chainage	21817
Inter station distance	1173
<b>Name Of Station No 20</b>	<b>Ambalan</b>
Station location	<b>KAZHIPATHUR</b>
Chainage	22947
Inter station distance	1130
<b>Name Of Station No 21</b>	<b>Vengai</b>
Station location	<b>METTU ST</b>
Chainage	24054
Inter station distance	1107
<b>Name Of Station No 22</b>	<b>Devaram</b>
Station location	<b>EAGTTUR BUS STOP</b>
Chainage	24054
Inter station distance	1128
<b>Name Of Station No 23</b>	<b>Ori</b>
Station location	<b>NAVALLUR MAIN ROAD</b>
Chainage	26359
Inter station distance	1177
<b>Name Of Station No 24</b>	<b>Arunan</b>
Station location	<b>SEMMANCHERI</b>
Chainage	27483
Inter station distance	1130
<b>Name Of Station No 25</b>	<b>Yaalvendan</b>
Station location	<b>THIRUVALLUVAR SALAI</b>
Chainage	28617
Inter station distance	1128



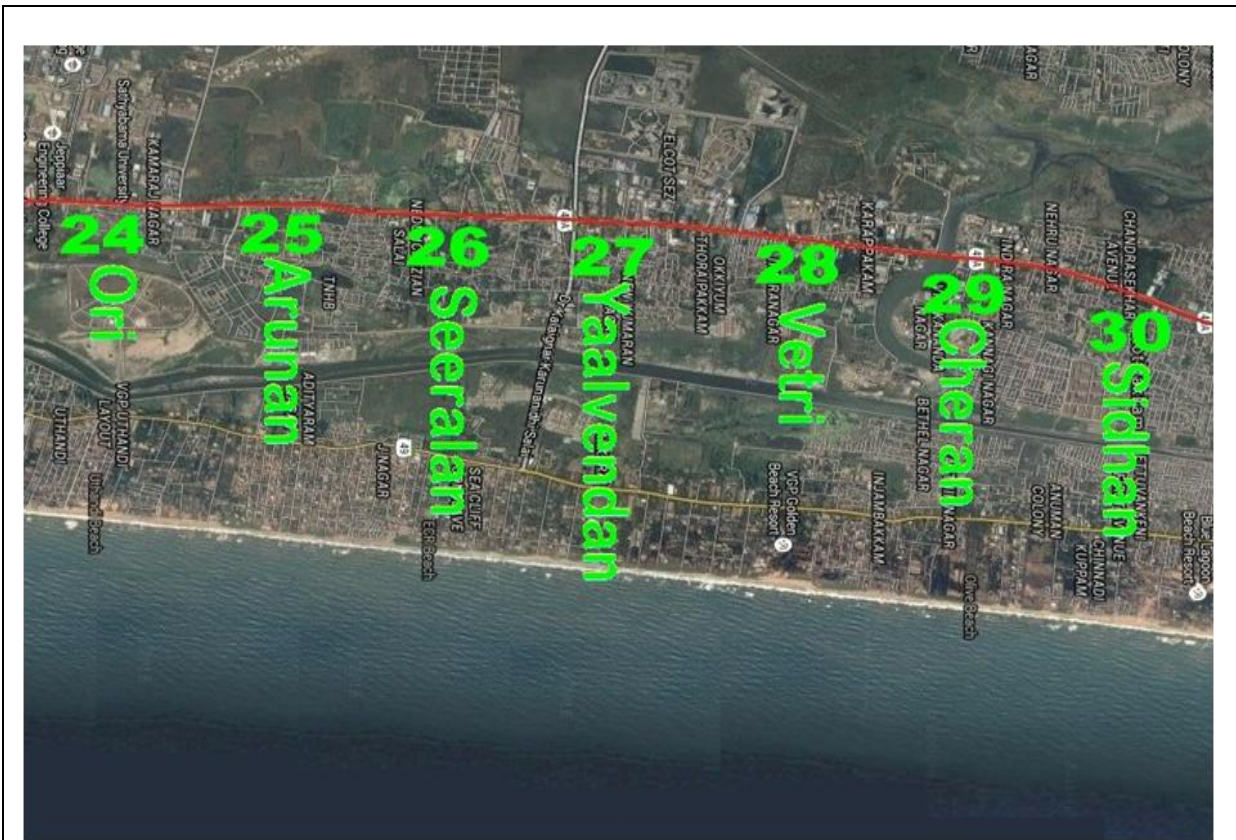

<b>Name Of Station No 26</b>	<b>Seeralan</b>
Station location	Kazhipattur
Chainage	29751
Inter station distance	1134
<b>Name Of Station No 27</b>	<b>Vetri</b>
Station location	Model School Road
Chainage	29751
Inter station distance	1161
<b>Name Of Station No 28</b>	<b>Cheran</b>
Station location	Karapakkam
Chainage	32020
Inter station distance	1.161
<b>Name Of Station No 29</b>	<b>Sidhan</b>
Station location	OKKIYAM THURAIPAKKAM
Chainage	33201
Inter station distance	1181
<b>Name Of Station No 30</b>	<b>Ulagan</b>
Station location	GANGAI AMMAN KOVIL ST
Chainage	34345
Inter station distance	1144

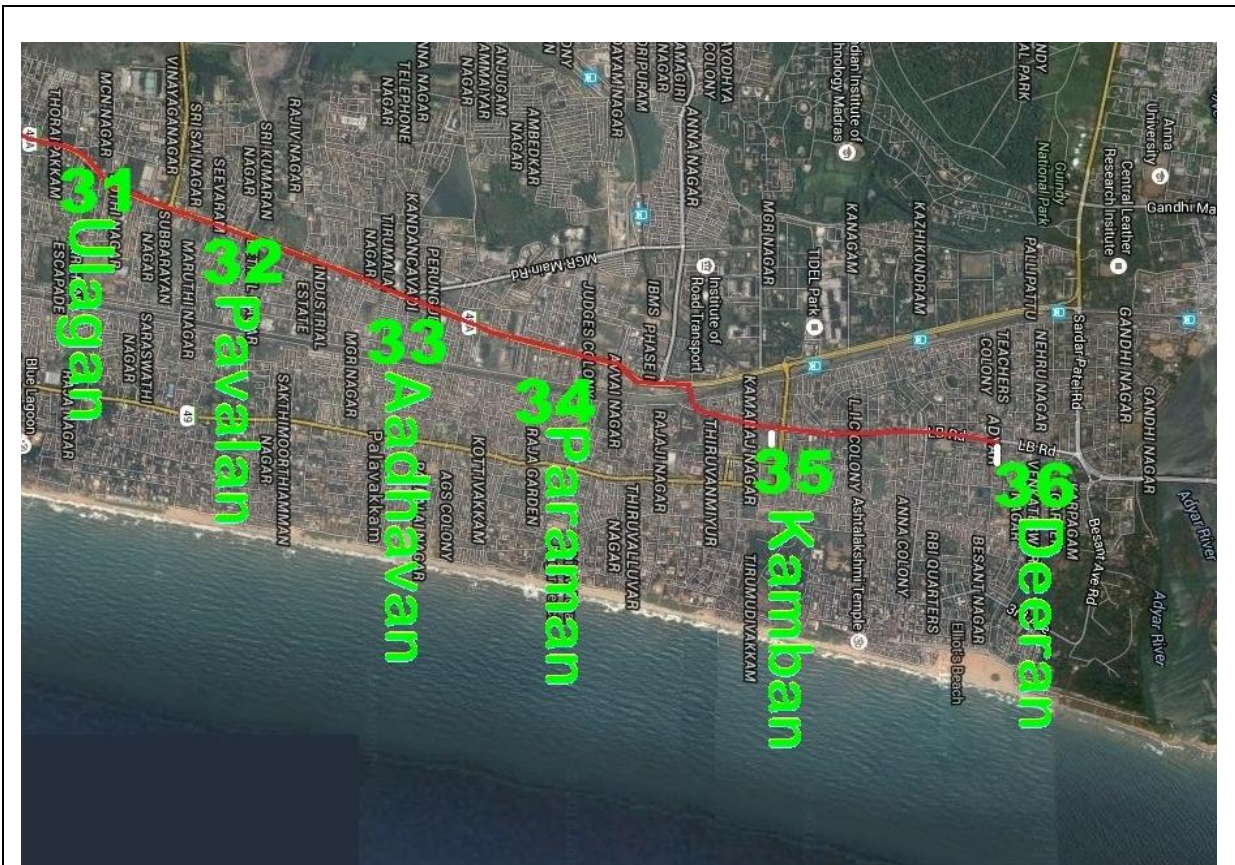

<b>Name Of Station No 31</b>	<b>Pavalan</b>
Station location	SAKTHI NAGAR MAIN ROAD
Chainage	35470
Inter station distance	1125
<b>Name Of Station No 32</b>	<b>Aadhavan</b>
Station location	NEW INDIA COLONY PERUNGUDI,
Chainage	36636
Inter station distance	1166
<b>Name Of Station No 33</b>	<b>Paraman</b>
Station location	SENTHIL NAGAR THURAIPAKKAM
Chainage	37769
Inter station distance	1133
<b>Name Of Station No 34</b>	<b>Kamban</b>
Station location	RAMALINGANAGR
Chainage	38904
Inter station distance	1135
<b>Name Of Station No 35</b>	<b>Deeran</b>
Station location	PERIYAR NAGAR
Chainage	40052
Inter station distance	1148





## **Station Planning**

Salient features of a typical station are as follows:

1. The station can be divided into public and non-public areas (those areas where access is restricted). The public areas can be further subdivided into paid and unpaid areas.
2. The platform level has adequate assembly space for passengers for both normal operating conditions and a recognized abnormal scenario.
3. The concourse contains automatic fare collection system in a manner that it divides the concourse into two distinct areas. The 'unpaid area' is where passengers gain access to the system, obtain travel information and purchase tickets. On passing through the ticket gates, the passengers enter the 'paid area', which includes access to the platforms.
4. The arrangement of the concourse is assessed on a station-by-station basis and is determined by site constraints and passenger access requirements. However, it is planned in such a way that maximum surveillance can be achieved by the station supervisor over ticket machines, automatic fare collection (AFC) gates, stairs and escalators. Ticket machines and AFC adequate circulation space.
5. Sufficient space for queuing and passenger flow has been allowed at the ticketing gates.
6. The DG set, bore well pump houses, ground tank and pump houses are located in one area at ground level.
7. The system is being designed to maximize its attraction to potential passengers and the following criteria have been observed:
  - Minimum distance of travel to and from the platform and between platforms for transfer between lines.
  - Adequate capacity for passenger movements.
  - Convenience, including good signage relating to circulation and orientation.
  - Safety and security, including a high level of protection against accidents.
8. Following requirements have been taken into account:
  - Minimum capital cost is incurred consistent with maximizing passenger attraction.
  - Minimum operating costs are incurred consistent with maintaining efficiency and the safety of passengers.
  - Flexibility of operation including the ability to adapt to different traffic conditions changes in fare collection methods and provision for the continuity of operation during any extended maintenance or repair period, etc.
  - Provision of good visibility of platforms, fare collection zones and other areas, thus aiding the supervision of operations and monitoring of efficiency and safety.
  - Provision of display of passenger information and advertising.
9. The numbers and sizes of staircases/escalators are determined by checking the capacity against AM and PM peak flow rates for both normal and emergency conditions. Lifts are provided for differently able commuters



10. In order to transfer passengers efficiently from street to platforms and vice versa, station planning has been based on established principles of pedestrian flow and arranged to minimize unnecessary walking distances and cross-flows between incoming and outgoing passengers.

11. Passenger handling facilities comprise of stairs/escalators, lifts and ticket gates required to process the peak traffic from street to platform and vice-versa (these facilities must also enable evacuation of the station under emergency conditions, within a set safe time limit).

The station is generally located on the road median. Total length of the station is 30 mts. All the stations are two-level stations. The concourse is divided into two parts located at either side of the road, with staircases leading from either side of the road to intermediate passage level and to platforms. The two halves are connected at intermediate level by a connecting passage which will facilitate crossing of road by others also.

Passenger facilities like ticketing, information, etc as well as operational areas are provided at the platform level. Typically, the concourse is divided into public and non-public zones. The non-public zone or the restricted zone contains station operational areas such as Station Control Room, UPS & Battery Room, Signalling Room, Security Room, Staff Toilets, etc. The public zone is further divided into paid and unpaid areas.

Since the station is generally in the middle of the road, minimum vertical clearance of 6.8-mts has been provided under the concourse. The Intermediate floor level is about 5.9-mts above the road. Consequently, platforms are at a level of about 11.5- mts from the road. .

With respect to its spatial quality, an elevated station structure makes a great impact on the viewer as compared to an *At-grade* station. Structures that afford maximum transparency and look similar to the surroundings have been envisaged. A slim concrete form is proposed with sloping tiled roof, as it would look compatible in both; the modern high-rise environment as well as the lesser-built, low-rise developments along most parts of the corridor. Platform roofs have been proposed to be of steel frame with tile cladding to achieve a look compatible with the traditional sloping roof structures around. Platforms would be protected from the elements by providing an overhang of the roof and sidewalls would be avoided, thereby enhancing the transparent character of the station building, while also allowing for the air flow required in the warm and humid tropical climate.

In order to allow unhindered traffic movement below the stations, the station structure is supported on a single column, which lies unobtrusively on the central verge.



### Passenger Amenities

Passenger amenities such as ticketing counters / automatic ticket vending machines, ticketing gate, etc. are provided in the concourse. The requirement of the facilities varies from station to station. The same applies to provision of platform widths and staircase /escalators.

### Concourse

Concourse forms the interface between street and platforms. In elevated stations, this is contained at single sides of the station. This is where all the passenger amenities are provided. The concourse contains automatic fare collection system in a manner that divides the concourse into distinct *paid* and *unpaid* areas. The '*unpaid area*' is where passengers gain access to the system, obtain travel information and purchase tickets. On passing through the ticket gates, the passenger enters the '*paid area*', which includes access to the platforms.

The concourse is planned in such a way that the station supervisor can achieve maximum surveillance over ticket machines, automatic fare collection (AFC) gates, stairs and escalators. Ticket machines and AFC gates are positioned to minimize cross flows of passengers and provide adequate circulation space. Sufficient space for queuing and passenger flow has been allowed in front of the ticketing gates.

### Ticketing Gates

Ticketing gates' requirement has been calculated taking the gate capacity as 20 persons per minute per gate. At least two ticketing gates shall be provided at any station even if the design requirement is satisfied with only one gate. Uniform space has been provided in all stations where gates can be installed as and when required.

### Ticket Counters and Ticket Issuing Machines (TIMs)

It is proposed to deploy manual ticket issuing in the beginning of the operation of the line. At a later stage, automatic TIMS would be used for which space provision has been made in the concourse. At present, ticket counters would be provided, which would be replaced with TIMS in future. Capacity of manual ticket vending counters is taken to be 10 passengers per minute and it is assumed that only 40% of the commuters would purchase tickets at the stations while performing the journey. The rest are expected to buy season tickets or prepaid card, etc. Accordingly, the requirement of ticket counters has been calculated and the same provided for in the plans.

### Platforms

A uniform platform width of 3.0-m wide excluding staircases and escalators in the end section is proposed for the elevated stations.





### **Stairs, Escalators and Lifts for Normal and Emergency Operations:-**

On each side of the station, one escalator and one staircase, 2.4 mts wide is provided connecting the platforms to the ground. These stairs and escalator together provide an escape capacity adequate to evacuate passengers in emergency from platforms to concourse in 7.5 minutes. While calculating the waiting passengers on the platform in emergency, 1 missed headway is assumed and the train arriving is assumed to be carrying peak sectional load.

### **Fire Fighting Measures**

Fire fighting provisions in metro stations are made in accordance with the “Chennai corporation Building Rules, according to which all requirements in respect of fire protection shall be in part IV, Fire protection in the National Building Code of India 1983 and amendment no. 3 under Fire protection Annexure II. National Building Code (clause 6.4.8). Fire protection and fire fighting system for metro stations stipulates: -

#### **Wet riser system**

- a. Main and diesel pump of 1800 l/min capacity to support 3 to 4 hydrant at a time [station building is split into two halves. It is presumed that fire will not break in the two parts simultaneously. There are 3 hydrants in one part. Therefore pump capacity as above are proposed
- b. Jockey pump 180 l/min shall also have DG back up.

#### **Internal Hydrant**

- The internal hydrant is provided with 2 nos RRL hose pipes of 38 mm Ø with 63 mm standard instantaneous coupling along with associated branch pipe and cabinet and a first aid hose reel of 25 mm Ø length 45m fitted with 6.5 mm nozzle.
- One hydrant each at ground level, passage level and platform level in each half of the station building and so located that every part of station is within 30 m radius.
- Sprinklers are provided in the property development area only. Additional sprinkler pump is not provided as these are not required being the integral part of the station. The two pumps already provided will take care of sprinkler flow requirements.
- Detectors are provided in the operational areas only and above false ceiling if the gap is 750 mm.
- One manual call box at each level in each half of the station building is provided.
- The HT panels, LT panels, main LT distribution board and essential power panels
- shall be provided with linear heat sensing tubes with CO2 cylinder.
- A two way fire brigade inlet at ground level on each rising main for hydrants is provided.
- Draw off connection is provided on the fire water tank for fire brigade.
- Water tank of 50,000 liters capacity is planned since commercial development is restricted to 250 sqm.



- Portable fire extinguishers (CO<sub>2</sub>) a set of two is provided in each of the equipment room. Summary of passenger amenities required and proposed at stations.

### **Signalling and Telecommunication**

The most advanced communication based train control (CBTC) system, generally conforming to IEE 1474 and ATS (Automatic Train Supervision) has been proposed. Signalling and train control system will be capable of running trains at operation headway up to 120 seconds (design headway of 100 seconds). Provision for automatic train operation as well as driverless train operation has been kept.

### **Driverless Train Operation**

In a driverless operation system, trains run without a driver in the cab. Train operation and status is remotely controlled and adjusted from the OCC based on the two-way Radio Frequency Communication Based Train Control (CBTC). This high-end system minimizes faults and operation delays through securing redundant systems and automatic route change functions. This operation system also ensures safety through minimizing human error, which accounts for the largest portion out of the cause of railway accidents. For certifying the Signalling system an independent safety assessor will be required to audit the Signalling system and suppliers process and approve the same for safety certification. The main bearer of the bulk of the telecommunication network is proposed with optical fiber cable system.

Considering the channel requirement and keeping in view the future expansion requirements a minimum 48 optical fiber cable is proposed to be laid in ring configuration with path diversity. There will be passenger announcement system, passenger information display system, centralized clock system and closed circuit Television (CCTV) system at all stations. In addition, there will be mobile radio communication between the trains and operation control centre (OCC).

### **Traction and Power Supply System**

They are renewably powered or run off the electric utility grid. It is a light rail system that is low cost and reduces energy requirements. This is due to the use of efficient traction energy, recapture of energy when braking for reuse when accelerating, and the re-arranged steel reinforced concrete track structure designed to simplify and reduce materials. Passenger rail cars can use light-weight composite materials as well. We use a standard innovative mix of rail and automotive components. These materials are long lasting, well tested, and require little maintenance. This further lowers energy demands, costs and effects on the environment.

Using renewable power sources that tend to be low in high power electricity output is now possible by capturing, condensing and storing this energy. The ET solution uses continuous power storage to overcome this lacking and has it available for the next arriving vehicle.



Upon sensing vehicle arrival at a station the ET system quickly transfers this stored power to the vehicle and stays connected for up to a minute using station power to accelerate the vehicle saving stored power already on the vehicle. Other criteria improved upon were the capture and rapid transfer to a secondary storage device onboard the vehicle that would make it possible to eliminate power source wires (catenaries) typically used over the whole route on other transit systems.

The use of quick charge power accumulators, the Ucaps, reduces the peak power from a source, decreasing size and cost of substations. Current systems use a substation costing over \$400,000 each connected to high voltage and power. These use high output for small durations of time causing variations of voltages of over +/-10% straining electrical components.

The ET enables the transit system to be more efficient and reduce energy usage and fluctuation. The team combined new and proven technologies into a well-integrated, efficient energy management system. The objective was to use renewable energy from solar panels to supply the on-board battery and Ucap storage system. Once the low power emitting solar energy was successfully captured it could remain in the Ucap storage unit for a very long time. Per their specifications the Maxwell Ultracapacitors uses will lose less than 1% of the stored power over a 24 hour period.

Traction current is carried through rails of suitable cross section fixed on both sides of the track beams. The traction voltage will be 750 V. D.C (+ 375V and – 375V). Two receiving sub stations have been proposed one in the car Depot and the other in the station in ground space. They will be of 2 x115 MVA capacities each. Traction sub stations have been proposed at 4 stations viz. Each station shall be provided with an independent Auxiliary Sub Station (ASS) to meet the power requirements of lighting, ventilation, air conditioning, for operation of lifts and escalators etc. Stand by diesel generating sets of 100 KVA to 125 KVA capacities will also be installed as a standby arrangement to cater for emergency requirements.

### ***Electric Power Tariff (Net Metering system)***

The cost of electricity is a significant part of operation & maintenance (O&M) charges of the Double Decker Maglev **MTC TRANS** System, which constitutes about 10-15% of total annual working cost for only the Auxillary Sub Station (ASS). The project makes use of the AC current supplied by the PEB (Tamil Nadu Electricity Board) only for the electrical utilities at each and every station premises. This is expected to be in the range of Rs. 3.50 – 4.00 per unit (This rate is also applicable at “The Delhi Metro”. The excess power that the Maglev magnetic system produces is exchanged with the PEB. All the stations have the Net Metering facility.



### ***Ticketing and fare structure***

MMDDRTS Systems handle large number of passengers. Ticket issue and fare collection play a vital role in the efficient and proper operation of the System. To achieve this objective, ticketing system shall be simple, easy to use/operate and maintain, easy on accounting facilities, capable of issuing single/multiple journey tickets, amenable for quick fare changes and require overall lesser manpower. In view of above, computer based automatic fare collection system is proposed. For Multiple Journey, the Store Value Smart Card shall be utilized and for the Single Journey, the media shall be Contactless Smart Token. AFC system proves to be cheaper than manual system in the long run due to reduced manpower cost for ticketing staff, reduced maintenance in comparison to paper ticket machines, overall less cost of recyclable tickets (Smart Card) in comparison to paper tickets and prevention of leakage of revenue. The AFC equipment shall be provided at each station at convenient locations and will be connected to a local area network with a computer in the Station Master's room.

Proposed fare structure for adoption in the year 2018 has been arrived at based on the existing bus fares (increased by about 1.5 to 2 times) and comparing with the fares adopted on the Delhi Metro Rail system. The initial fares to be adopted are indicated below:-

The following sections highlight the objectives of the station, including the urban design objectives. It also describes the architectural vision, site planning issues, opportunities and constraints, and station design.

### ***Entrances***

Station entrances will be located with particular reference to passenger catchment points and physical site constraints within the right of way allocated to the station. Integrated entrances

- provide highly visible station entrances and address,
- station entrances relate to existing pedestrian networks and nodes, to maximize connectivity,
- station entrance planning is sympathetic with existing urban context heritage structures and landscape element,
- Station Planning,
- station planning focuses on connecting with and enhancing the existing public domain,
- station planning facilitates future opportunities for connections with adjacent landowners,
- station planning to accommodate passenger forecast and incorporate flexibility for expansion,
- the concourse level planning provides direct and clear passenger flows with access to ticketing, station, public and retail facilities from passenger convenience and comfort,
- the design of the station layouts will serve and ensure passenger convenience, safety and comfort.





### **Station Accommodation**

Office accommodation, operational areas and plant room space is required in the non-public areas at each station. Wherever possible, emergency generators, transformers, pump houses, cooling tower plants, and water sumps will be located at ground level, preferably in one area of the station site.

### **Station Environment**

Customer ease of use will be a priority on a number of levels. The first level concerns the ability of the public to easily locate and access the station, including the wider precinct area; this will sit comfortably in its local surroundings approaching the station indicating the entrance. Readily available information will be provided regarding services and amenities in the station environs. A simple way-finding policy will deliver signage that is clear, easy to read and caters for all modes of arrival at the station, a range of languages spoken (Tamil, English, Hindi) and impairments. Advertising, retail and non-essential signage will not impair way-finding. Customers with reduced mobility will be able to access and use the station independently through the provision of lifts. Access to stations outside the city centre will be provided for with a hierarchy of priority according to the sustainability of the access mode. This places pedestrian access first with cyclists and other public transport users next and finally Kiss and Ride/Taxi drop off. The seamless transfer between transport modes at interchanges is a key feature of the experience.

### **Station Ambience**

The whole station environment will be attractive, welcoming, and easy to navigate and well maintained through the use of robust materials and the implementation of a station cleaning and maintenance regime that is regularly monitored and effectively managed. Building materials and finishes will be sustainability sourced wherever possible.

Efficient use will be made of resources such as water, electricity and natural light. In order to make an attractive transport option over alternative modes, customers should be comfortable throughout the journey. The thermal conditions in the station will therefore be controlled so as to be comfortable for the majority of passengers. There should not be a severe temperature difference when stepping between the air conditioned trains and the platforms, as it is large differences in temperature that particularly cause discomfort.

Crime risks will be mitigated by design including the provision of Ticket Gates to separate those who have business being from those who do not. All stations will be smoke-free supported by clear signage informing of the no smoking policy. There will be a zero-tolerance attitude to graffiti, meaning it will be removed from all stations (and trains) within 24 hrs. Those found guilty of applying graffiti will be prosecuted, as strong tactics will be required to overcome a problem that is endemic on other forms of public transport within CHENNAI Community art will be facilitated in designated areas on MTC TRANS property.



Litter bins will be provided and customers will be given the opportunity to recycle their rubbish through the use of separate bins. This will be subject to appropriate security measures such as transparent bins/bags and regular emptying. Waste storage areas will not be visible to customers, but will facilitate ease of collection.

### **The Station Experience**

#### **Shows the recommended alignment and stations**

Stations will be staffed during operational hours with a presence on the concourse and on the platform. During non-operational hours the stations will be secured by shutters or similar devices, with access made available for maintenance and cleaning staff. During the early operational phase, a prominent staff presence on platforms is important for passenger safety perceptions especially while boarding and alighting from the train. Staff will be able to override automatic Platform Screen Doors if necessary and deal with door obstructions in the train. A staff presence on the platform supports passenger security and provision of information especially if there are service disruptions.

Staff presence on the concourse is important to deal with any problem with the ticket gates, and in deterring fare evasion. Staff will also be available to assist customers becoming accustomed to the automatic ticket machines. An important factor in the recruitment of staff will be attitude towards customer service. Staff skills and competencies will be further developed for customer service, conflict resolution and safety as well as in specific job skills. Staff will have the knowledge to deal with enquiries about local destinations and connecting transport services.

A clear Position Description will accompany each role and staff will have structured opportunities to contribute to continuous improvement as well as receive performance feedback. Equipment required to carry out tasks efficiently and effectively will be provided and well maintained. This will include use of modern technology such as Personal Digital Assistants to keep the staff up to date on operational issues and to enable them to communicate with ease.

A culture of pride in customer service will be nurtured from induction which will be informed by Customer Service Vision and Customer Service Statement and will be developed through customer engagement will be used at all stations. They will be interlocked with the train doors and have the capability to detect obstructions for customer safety. Furthermore they will:

- Be configured to authorize doors opening where a train is within +/-400mm of its specified stopping point
- Fully open all doors within 60 to 90 seconds of train coming to a standstill
- Be designed to be up to 800mm wider than the train doors where this is necessary to achieve train stopping accuracy
- Only open when a stopping passenger train can be positively detected on that platform



- Interface with the train so that the PSDs will only open when the train door open signal is detected
- Allow viewing of the upper part of the train by the use of glass panels. Clear labeling will be used to indicate where the wheelchair and stroller spaces are located on the train
- Provide a complete barrier to the platform edge, sealed sufficiently to prevent significant air movement
- Provide diagnostic information on a range of health conditions of the PSDs
- Have a control point situated near the platform for use by train or station staff in times of degraded operation or emergency

Security cameras, automated and manual Public Address and customer information screens will be provided, all of which will be compliant with the Disability Discrimination Act and other relevant legislation. Staff on platforms will have mobile access on that platform. Customer toilets will be provided within the paid area of the station. Retail facilities will be provided in the stations where there is limited access to other opportunities to purchase newspaper or refreshment in the surrounding area.

### ***Access for All***

One of the unique features of this system is that the entire route will be fully accessible, enabling mobility impaired customers to travel independently if they so wish or to be provided with assistances required. This will be reflected in the Disabled People’s Protection Strategy together with provisions for other customers with special needs.

### ***The following Special Facilities will also be provided***

- Clearly labelled wheelchair positions inside each train,
- Dedicated train boarding areas for the access and egress of wheelchairs,
- Wide ticket gates, capable of self-closing with an electrically operated release, installed in the ticket barrier between the paid and un-paid areas,
- Priority seating on platforms,
- Customer Information Screens for hearing impaired passengers,
- Escalator audible devices for indicating the location of escalators,
- Passenger lifts with tactile landing buttons, handrails, and voice announcements.

### ***Customer Information***

The provision of accurate, high quality and simple to understand information is one of the most basic requirements for customers, especially during times of disruption and is a key issue that can determine the perceived quality of the customer experience. It will therefore be a priority for the MTC TRANS to provide:



- Clear, visible and audible train running information on entry to the land on platforms, which provides a countdown to the next 3 trains,
- A general statement of the performance of the network that day and running information for other services at interchange locations,
- A consistent quality of customer information even during periods of degraded service when manual announcements may be required,
- Accessible help-points to enable customers to contact staff in an emergency or to obtain train running information,
- Customer Service staff that are well informed and 'happy to help', and
- The majority of customer information will be automated. Standards will be set for the provision of information, announcements and printed information to ensure clarity and consistency.

### **Other Station Facilities**

A combination of all substation lifts, main station only escalators and stairs will be provided stations to cater for the needs of all users. Temperature and other conditions will be made comfortable for passengers in the station and on platforms. Seating will be provided on all platforms with a dedicated area for priority seating, so the staff can easily identify those customers that will need assistance. Designated boarding points for wheelchair users will also be clearly marked. Customer toilets in the paid will be made available at all times during the hours of operation and will include baby change facilities and disabled facilities. They will be clean and odorless and monitored by the staff on a regular basis. A number of the stations are located within easy reach of large retail facilities and so the provision of retail outlets within the station precincts needs to be appropriate to the local situation. Providing a basic level of retail services is seen as part of the customer service that the **MTC TRANS** offers passengers, and the revenue that such retail can generate is an important consideration. The safety measures for the customers, employees, to the working system are separately dealt in the sub-heading – safety and security of systems.

### **Ticketing, Fares and Revenue Protection**

The MTC TRANS will be gated and therefore all customers will be required to purchase a valid ticket to enter and exit the system, simplifying the revenue protection policy.

### **Station Services**

#### **Illumination**

The illumination level shall conform to Indian & International standards. Wherever traffic integration areas are provided on the station premises of **MTC TRANS** system, outdoor illumination either through poles or high masts, as appropriate, shall be provided.





### **Elevators**

Lifts for use by passengers specially for differently able persons shall be provided as planned as per norms adopted elevator will be required to be provided at the stations from ground to concourse and concourse to platform, the AFC gates to be planned accordingly.

### **Water Supply & Pumping**

Stations shall be provided with water supply for washing as well as for fire protection measures. Water supply & pumping services shall be provided.

### **Ventilation & Air-conditioning**

Elevated stations shall have normal ceiling fans and illumination for operational needs. VRV / VRF air-conditioning for signal and telecom and AFC equipment shall be provided according to need. The ECS (Environment control system) shall include the ventilation by exhaust fans of plant rooms and toilets etc.

### **Power Supply for Signals**

The primary source of power supply for signalling and telecommunication will be MTC TRANS Authorities 33 kV/415-volt 3-phase dc power distribution system.

### **Standby Diesel Generator (Dg) Sets**

In the unlikely event of simultaneous tripping of all the RSSs or grid failure, the power supply to stations as well as to trains will be interrupted. It is, therefore, proposed to provide standby DG set of 100KVA to 125KVA capacity at elevated/at-grade stations and 500 KVA capacity for Depot to cater the following essential services:-

- Lift operation,
- Essential lighting,
- Signalling & telecommunications,
- Fire fighting system.

Silent types of DG sets are proposed which have low noise levels and do not require separate room for installation.

The entire system of power supply (receiving, traction & auxiliary supply) shall be monitored and controlled from a centralized Operation Control Centre (OCC) through SCADA system being provided at Maintenance Depot near MAHABALIPURAM at Poonjeri. Modern SCADA system with intelligent remote terminal units (RTUs) shall be provided. Optical fibre provided for telecommunications will be used as communication carrier for SCADA system.

Digital Protection Control System (DPCS) is proposed for providing data acquisition, data processing, overall protection control, interlocking, inter-tripping and monitoring of the entire power supply system consisting of 66/33kV&I 10/33KV ac switchgear, transformers,



750V dc switchgear and associated electrical equipment. DPCS will utilize microprocessor-based fast-acting numerical relays & Programmable Logic Controllers (PLCs) with suitable interface with SCADA system.

### **General Criteria**

Certain general criteria for finish materials are indicated below to achieve the goals outlined above as well as those, which would result in a high level of illumination, good cleanliness levels, and the appearance of high cleanliness.

### **Surface**

Applied materials shall be hard, dense, non-porous, non-staining, acid and alkali resistant, of long life and low maintenance. Surfaces within reach of the public, up to 3 m above the floor level may be finished with applied materials.

### **Colour**

Colours shall aid maintaining high illumination levels, with sufficient contrasts and accents to provide visual interest and warmth and to conceal minor soiling.

### **Texture**

Smooth surfaces should be preferred over rough ones for ease in cleaning and being less prone to catch settling dust. Rough surfaces are desirable where a skid resistant feature is important, and are acceptable where surfaces are difficult to reach. A distinctive texture shall be provided at the platform edge when open or operable to the tracking to enable the blind to sense the platform edge.

### **Unit Size**

Unit should be large enough to reduce the number of joints yet small enough to conceal minor soiling and scratches and to facilitate replacement if damaged. Monolithic materials may be used if they have inherent soil hiding characteristics that can be easily repaired without the repair being noticeable.

### **Joints**

Joints should be small, flush, limited in number and using the best possible materials. Horizontal joints should not be raked but should be flush or tooled concave. Monolithic materials should have adequate control joints and expansion joints at the proper spacing in order to prevent surface cracking.



### **Cost**

Materials shall be selected for long life, low maintenance, easy to replace and overall aesthetic and functional qualities.

### **Availability**

Materials selected should be readily available. Domestic products shall be selected unless the product is not available within the country.

### **Proprietary Materials**

Proprietary items shall only be used where it is established that no other materials would meet the particular design requirements.

### **Installation Standards**

Materials shall be detailed and specified to be installed in accordance with industry standards and manufacturer's printed directions.

### **Flammability**

- Interior finishes including doors/ windows shall meet requirements of the code and the fire/life safety requirement,
- Finishes for all protected exit ways shall be Class A as defined by NFPA 101. Corridors, stairways, and vestibules shall be considered exit ways,
- finishes in all other areas shall be Class B as defined by NFPA 101, and
- Combustible adhesives and sealants may be used when they meet the requirements stated above.

### **Basic Requirements Safety**

Fire Resistance and Smoke Generation Use materials with minimum burning rates, smoke generation, and with less toxicity characteristics.

### **Fire/Life Safety requirements**

- Eliminate hazard from dislodgment due to temperature change, vibration, wind, seismic forces, aging, or other causes, by using proper attachments of adequate bond strength.
- Skid-resistant (for walking surfaces) Use floor materials with skid-resistant qualities. Entrances, stairways, platform edge strips, and areas around equipment should have flooring having high skid-resistant properties.
- The following static coefficients of friction shall be provided as a minimum,
- Coefficient of Friction ,
- Public horizontal surfaces-0.6,



- non-public horizontal surfaces, interior-0.5,
- non-public horizontal surfaces, exterior-0.6,
- stairs, ramps, sloping sidewalks-0.8, and
- Area around equipment-0.6.

### ***Durability***

Use materials with wear resistance, strength, and weathering qualities consistent with their initial and replacement costs, and their location in the Station. The materials must maintain good appearance throughout their useful life. Materials shall be colourfast.

### ***Ease of Maintenance and Cleaning***

Use materials which do not soil or stain easily, which have surfaces that are easy to clean in a single operation, and on which minor soiling is not apparent. Materials shall be cleanable with standard equipment and cleansing agents.

### ***Repair or Replacement***

Use materials which, if damaged, are easily repaired or replaced without undue interference with the operation of the System. Spare materials shall be available for tile and other unit materials. (Say a quantity of approximately two percent of the total used.).

### ***Aesthetic Qualities***

Create feeling of warmth, attractiveness, quality, and civic pride in the facility.

### ***CCTV***

Rolling stock and infrastructure condition monitoring and alarm systems.

### ***British Standards (BS)***

American Architectural Manufacturers Association (AAMA).

### ***NFPA Codes***

Landscaping at Elevated Station Complex and Guideway Alignment

Landscaping of all areas within the Rail System shall be undertaken in consultation with the Government.





**Stairs, escalators and lifts for normal and emergency operations Rail Car System Alignment**

- Suitable landscaping and appropriate vegetation along the route of the viaduct shall be provided to improve the aesthetic appearance.
- Shrubs, trees and ground cover suitable to their location and the city environment shall be provided within the full length of the central median to improve and soften the impact of the structure on the city scene after completion of construction.
- Watering points shall be provided at appropriate centres along the median.

**Facilities in and around Station Areas**

Appropriate planting should be provided to enhance and soften the appearance of the Station box, the approach structures and the inter change areas.

**Rain Water Harvesting & Fencing**

The rain water harvesting of the runoff water within the Station areas shall be planned as per the policy, rules, norms, requirements and methods of the State and the Central Government.

The Concessionaire shall provide appropriate vandal-proof perimeter fencing at suitable locations, determined in consultation with the IE, along the entire reserve boundaries at both sides of the Rail System including Depots, Stations, installations, buildings etc.

**Environmental Protection Requirements**

The Concessionaire shall implement the environmental protection requirements applicable to the Works.

**Noise**

- The design of the permanent works shall comply fully with the following requirements:
- All parts, including non-structural parts, of the structures shall minimize as far as practicable the radiation of noise due to vibration caused by the passage of Trains. Particular attention shall be paid to the minimization of noise at the low end of the acoustic frequency spectrum,
- Walls and slabs intended to contain airborne noise from the Trains shall be of concrete of 200 mm minimum thickness and shall be purpose-made, non-combustible and vibration absorbing / dampening, and shall utilize GRC panels or similar construction.
- Allowable Range of Noise levels:
- The allowable range of noise levels for different land uses are:  
Residential: 50 – 70 dbA  
Business and Commercial: 75 dbA  
Hospitals: 60 dbA  
Rural: 45 – 50 dbA



### **Provision of Noise barriers**

Noise shall be reduced to locally acceptable levels by provision of low vibration track forms, resilient base plates, design of parapet walls and treatment of their track side surface. They shall be supplemented by providing sound absorption material on sides of the viaduct superstructures. Additional noise barriers shall be provided in lengths of viaducts and bridges passing through sensitive residential or hospital zones. The choice of barrier type and their disposition along the parapet / railing shall be closely related to aesthetics of the structures.

### **Accommodating Structures**

The welded steel or reinforced concrete guideway beams way for geometric design, general features specifications and requirements for accommodating structures forming part of the **MTC TRANS**,

- The horizontal and vertical alignments of the shown in the DPR are for general guidance purpose. The Concessionaire shall design the engineering works to these alignments in general. However, minor changes to the given alignments may be made in consultation with the IE.
- Accommodating structures include all Structures/Buildings and E&Ms required for properly sheltering the Rail System including the maintenance equipment,

**Users and staff, and shall satisfy the following conditions:**

- Rail System shall function in accordance with the requirements specified.
- Staff shall fulfil their duties as per the operation plans in safe, healthy and efficient Conditions.
- The User flow can circulate in safe and comfortable manner even in case of Emergency.
- The accommodating structures shall allow the above mentioned functions for all operating conditions.

**Accommodating structures shall include, inter alia, the following:**

- Elevated guideway or viaduct.
- Bridges.
- Stations and auxiliary buildings.
- Depot area and buildings for maintenance facility.
- Other buildings/structures required for operation and maintenance.

### **Architecture**

The structures shall be aesthetically pleasing, sleek and be environment friendly, maximizing use of pre-cast structural elements.



### **Passage for Emergency Evacuation of Users**

A passage of width not less than 700 mm with safety railing shall be provided on each side of the double track all along the elevated corridor to facilitate evacuation of Users during Emergency.

### **Cable Ducts**

Provision shall be made in the design of the deck for ducts for laying electrical, Signalling and telecom cables.

### **Felling of trees**

Felling of trees shall be done only with the approval of the concerned authorities, and in compliance with all Applicable Laws.

### **Access Roads**

Construction of access road for vehicles, plant and machineries to approach the Site shall be with the approval of the concerned authorities.

### **Drainage Arrangements**

Properly designed drainage scheme for the elevated guideway structure, Stations and concourse and Depot shall be provided. All drains shall be of adequate size as per hydraulic calculations and shall be connected to the nearest underground drainage facilities or discharge facilities with the provision of sumps, man holes, cross drains etc. For fast track construction, use of pre-cast RCC standardized drain sections shall be adopted.

- Precaution against Flooding,
- Mitigating measures shall be taken in areas where flooding is likely to occur,
- Environmental Quality,
- The requirements of Environmental quality as per regulations shall be met,
- Elevated welded steel reinforced concrete guideway beams Structure – Features,
- Choice of Superstructure,
- The choice of superstructure shall be made keeping in view the ease of construction, fast track work and maximum standardization,
- Following types of superstructure are generally in use in India,
- Pre-cast segmental box girder using external un-bonded tendons, and
- Steel/concrete composite girders.

Any other type of superstructure found more suitable and appropriate for the site condition may also be adopted. In situ construction is not acceptable unless absolutely necessary in specific locations as reviewed by the IE.



### ***Sub-structure/Foundation***

Open or pile foundations may be adopted depending on the suitability of soil strata encountered. The pile cap/open foundation top shall be kept at least 500 mm below the road level so as to facilitate necessary drainage from the viaduct and crossing of utilities. For Rail bridges, foundation design shall take into account scour conditions in the river bed. For construction of pile foundations, rotary hydraulic drilling rigs with faster productivity shall be used.

### ***Deck Drainage and Waterproofing***

RCC surface drains at deck level shall be constructed along the viaduct route. Runoff shall be collected through surface drains that shall lead to down drains at the designated support columns and connected to a suitable drainage system. Provision for silt removal shall be made where necessary. All metallic components of the drainage system shall be seam welded for water tightness and given two coats of bituminous painting before placement. The whole assembly shall be placed in true position, line and level and held in place firmly.

### ***Roadway width during construction***

As most of the construction is to be carried out on the middle of the road, central two lanes including median will be required for construction activities. During piling and / or open foundation work, a width of maximum 8 m will be reserved for construction and the same shall be barricaded. It is essential that at least two lanes are always provided for traffic on either side of barricade during construction by widening of roads, if necessary. If site conditions do not permit the same, one way traffic may be resorted to in co-ordination with the traffic authorities. A detailed traffic management plan shall be prepared for each stretch of the route in consultation with the IE and shall be complied with.

### ***Barricades during construction and work site protection.***

- Barricades shall be erected and work site protected as per Specifications and Standards furnished.
- Housekeeping and Safety management at sites.
- Housekeeping of construction sites shall be professionally organized to render a neat and safe appearance at the sites. Suitable gaps (with lockable gates wherever feasible) in barricading shall be provided at planned locations to facilitate.
- Movement of cross traffic at junctions.
- Movement of construction materials and
- Security posts location.

The Concessionaire shall keep and maintain a well designed and detailed Safety Manual to be adopted at all his construction sites. Safety issues shall be given highest importance during





construction. Third party safety audits shall be conducted at maximum six months intervals at sites.

Necessary insurance policies (viz. comprehensive all risk insurance) shall be taken before start of site activities. Safety meetings shall be held at regular intervals with all stakeholders and state traffic police department.

**Accommodating structures shall include, inter alia, the following:**

- Elevated guideway or viaduct;
- Stations and auxiliary buildings;
- Depot area and buildings for maintenance facility;
- Other buildings/structures required for operation and maintenance; and
- Other civil works as required for proper functioning of the Rail System.

**Performance requirement**

All permanent and temporary civil works construction shall satisfy the major requirements of existing traffic flow. Normal traffic flow on the existing road at ground level shall not be disturbed until alternate and satisfactory arrangements are provided except during construction of foundations when road width shall be as per. Generally, no ground scaffold shall be erected for

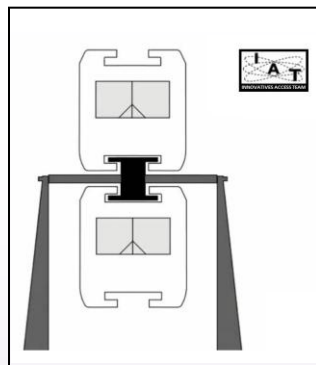

**World in balance**

- *Project 2015-25 (Future - Growth - Infrastructure / Logistics - Environment)*
- *Transportation Technology – Labour*
- *The better way THE FUTURE OF PROGRESS IAT "Double Decker Transrapid System"*
- *A revolutionary new traffic system in the near future*
- *Traffic Engineering our future*
- *Growth - Infrastructure - Logistics - Environment - Labor*
- *IAT provide more thousand new jobs*
- *Success with foresight*
- *Mass unemployment in many countries for decades may be considerably reduced.*
- *There is a way of avoiding a traffic collapse as it takes place right now in a lot of countries.*

*Transrapid, Double Decker Monorail, Proto-Type before Realization Inspiring the huge investment is the logical and efficient development of the well-known Transrapid system: with the Double Decker , single-beam monorail running with integrated implementation and locking solutions, personal and also freight vehicle traffic can be deployed, unhindered in two directions, using a revolutionary two-tiered, upper/lower carriageway system.*



## 10 - The Maglev

Magnetic levitation (maglev) is an innovative transportation and is a highly advanced technology. A further development of the system was through the **INNOVATIVE ACCESS TEAM IAT-MAGLEV** brought for patent maturity it is sometimes said to be the first fundamental innovation in the field of railroad technology since the invention of the railway. The most important usage of magnetic levitation is in operation of magnetically levitated trains. Magnetically levitated trains are undoubtedly the most advanced vehicles currently available to railway industries. The MMDDRTS train uses non-contact magnetic levitation, guidance and propulsion systems and has no wheels, axles and transmission. The replacement of mechanical components by wear-free electronics overcomes the technical restrictions of wheel-on-rail technology. Compared with traditional railways, MMDDRTS systems have features that could constitute an attractive transportation alternative, since Contrary to traditional railroad vehicles, there is no direct physical contact between MMDDRTS vehicle and its guideway. These vehicles move along magnetic fields that are established between the vehicle and its guideway. Conditions of no mechanical contact and no friction provided by such technology makes it feasible to reach higher speeds of travel attributed to such trains.

1. **High Speed**
2. **High Safety**
3. **Less Pollution**
4. **Low Energy Consumption**

### **Project Motivation**

Magnetism has fascinated humans for centuries. So we were looking for a project based on the concept of magnetism. The idea for this project came after discussing with the coordinators and reading a Scientific American Article that described proposed MMDDRTS systems around the world and their potential for future travel.

### **Our Project makes use of this technology**

#### **MMDDRTS**

MMDDRTS suspension system is divided into two groups of Electro Magnetic Suspension (EMS) and Electro Dynamic Suspension (EDS). There are varieties of vehicles that are manufactured based on these two types of systems. Vehicle path in EMS and EDS systems are called guideway and track, respectively. Basically, there are two main elements in a MMDDRTS system including its vehicle and the guideway. The three primary functions in MMDDRTS technology are levitation, propulsion, and guidance. Magnetic forces perform all of these. Magnets are used to generate such magnetic forces. For EMS systems, these magnets are located within the vehicle while for EDS systems magnets are located in the track.



### Electromagnetic Suspension Systems (EMS)

The electromagnetic suspension EMS uses attractive force system to levitate. The train's levitation magnet will be attracted to the conductors on the underside of the guideway. The attractive force between them will overcome the gravitational force. This will in turn levitates the train on the track.

The guidance magnet on the other hand guides the train so that the side of the track will not have contact with the train, creating friction and damages the train. The guidance magnets will also guide the train so that it will follow the direction of the guideway track.

### Electrodynamic Suspension Systems (EDS)

The electrodynamic suspension (EDS) train has been developed by Japanese engineers. It uses magnets that has same polarity (refer to figure above) to create repulsive force between levitation magnet and guideway magnet. This repulsive force then will be high enough to overcome gravitational force and allows it to levitate.

### EMS & EDS - Difference

The main difference between EDS maglev train and EMS maglev train is that EDS maglev train use super-cooled, superconducting electromagnets. This superconducting electromagnet can conduct electricity even after the power supply has been shut off for example in the event of a blackout. In the EMS system, which uses standard electromagnets, the coils only conduct electricity when a power supply is present. By chilling the coil at frigid temperatures, Japan's EDS system saves energy. However, the cryogenic system uses to cool the coils can be expensive.

An EMS system can provide both levitation and propulsion using an on board linear motor. The polarity of the stators (Figure 1) at the track will quickly change its polarity continuously to move the Maglev train. Stators at the sides are excited sequentially. The electromagnets onboard 'chase' the current forward along the track. The continuous magnetic field moving forward. Speed controlled by frequency of alternating current.

### Magnetic Levitation or Maglev Propulsion

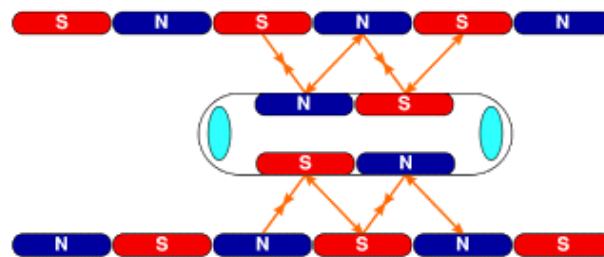



The process of propulsion for EDS is same as EMS except that the stators will stop for a moment after polarity change. Referred as "pull- then neutral- then push" system. Coils or Aluminum sheet at the sides. The direction of current of the particular segment is reversed. Polarity of that segment changes which causes repulsion.

Propulsion coils on the guideway are used to exert a force on the magnets in the train and make the train move forward. The propulsion coils that exert a force on the train are effectively a linear motor. The linear motor in the guideway functions just like a conventional electric motor with its stator cut open and stretched out over the length of the guideway. Instead of a magnetic rotary field, the current in the windings generates a magnetic field of travelling waves, which pulls the vehicle without contact. By changing the intensity and frequency of the driving current, speed and thrust can be continuously adjusted. When the motor is operated as a generator, the direction of the energy flow is reverted and used for contactless braking.

An alternating current flowing through the coils generates a continuously varying magnetic field that moves forward along the track. The frequency of the alternating current is synchronized to match the speed of the train. The offset between the field exerted by magnets on the train and the applied field create a force moving the train forward.

A linear motor or linear induction motor is essentially a multi-phase alternating current (AC) electric motor that has had its stator "unrolled" so that instead of producing a torque (rotation) it produces a linear force along its length. The most common mode of operation is as a Lorentz-type actuator, in which the applied force is linearly proportional to the current and the magnetic field ( $F = qv \times B$ ).

Many designs have been put forward for linear motors, falling into two major categories, low-acceleration and high-acceleration linear motors. Low-acceleration linear motors are suitable for maglev trains and other ground-based transportation applications.

The force is produced by moving linear magnetic field acting on conductors in the field. Any conductor, be it a loop, a coil or simply a piece of plate metal, that is placed in this field will have eddy currents induced in it thus creating an opposing magnetic field. The two opposing fields will repel each other, thus forcing the conductor away from the stator and carrying it along in the direction of the moving magnetic field.

Free body diagram of a linear motor. The view is perpendicular to the channel axis. The two coils at center are mechanically connected, and are energized in 'quadrature' (with a phase difference of  $90^\circ$  ( $\pi/2$  radians)). If the bottom coil (as shown) leads in phase, then the motor will move downward (in the drawing), and vice versa.





### **Advantages of maglev**

- High speed but, safe.
- It doesn't have moving parts as conventional trains do, and therefore, the wear and tear of parts is minimal, and that reduces the maintenance cost by a significant extent.
- There is no physical contact between the train and track, so there is no rolling resistance. While electromagnetic drag and air friction do exist.
- Absence of wheels, no deafening noise.
- Environment friendly, as they don't resort to internal combustion engines.
- Are weather proof, which means rain, snow, or severe cold don't really hamper their performance.
- Experts are of the opinion that these trains are a lot safe than their conventional counterparts as they are equipped with state-of-the-art safety systems, which can keep things in control under any situations.

### **Maglev in other countries**

- France: (Rail network name: Train a grand vitesse). Began operations in 1980s.
- Japan: (Rail network name: The shinkansen long distance trains-Bullet train).

Also US, Europe are the leading countries that are getting benefitted day by day by this innovative means of rail transportation system. With means of least number of accidents in the world and considered one of the safest means of transport in rail engineering.

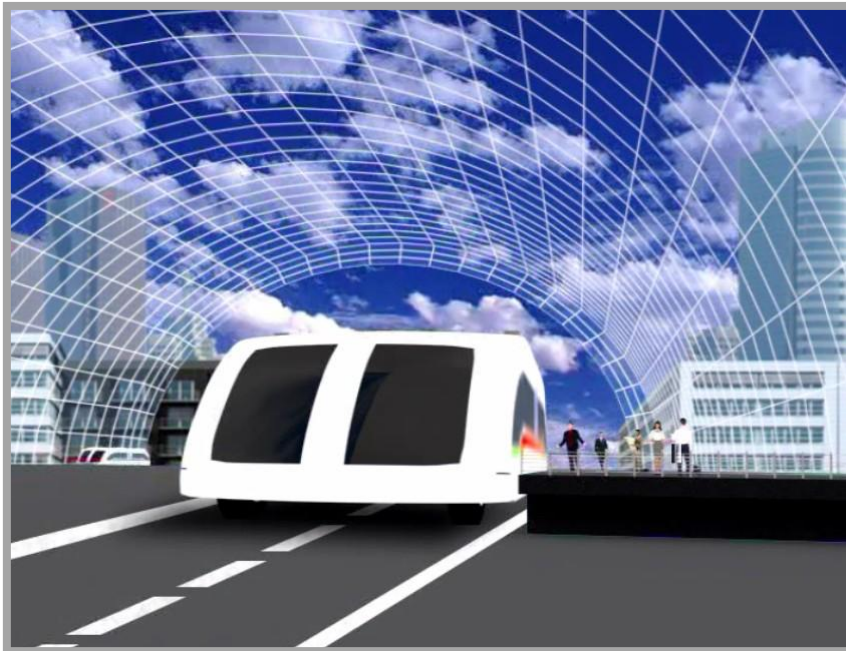

**The Coaches Will Be Moving on Wheel Support at Station near Ground Level**



### GUIDEWAY PILLAR AND POLYGON MID SPAN WITH VEHICLE SUSPENSION.

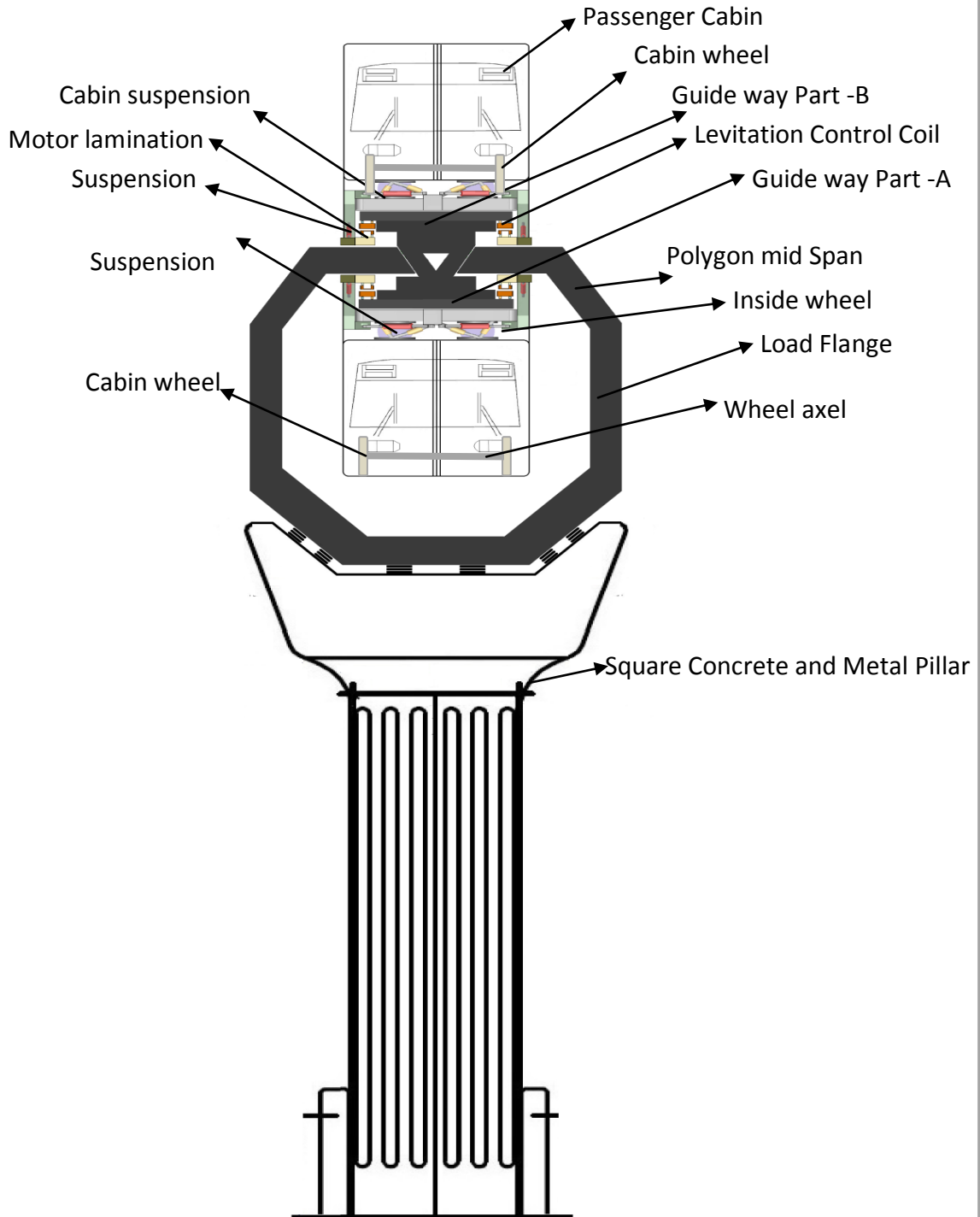

### IAT - MAGLEV MAGNETIC DOUBLE DECKER TRANSPRAPHIC SYSTEMATIC DESIGN



## **II - OPERATIONAL PLAN**

Choosing the **MTC TRANS** and the integration of transport systems with the advent of new and modern public transport systems, the authorities could rationalize on the suitability of the mode based on the cost to benefit analysis and the growth policies and strategies for the city. Although the city has the requisite density for all the three modes, other parameters such as road width, land acquisitions, political will, bureaucracy and policies creates discrepancies in making choices which would optimize the density and potential users.

Chennai people and a density of over 25,000 people per square kilometre. It has a rich colonial architectural history besides the native heritage buildings and a transforming skyline. The city is called the Detroit of the east as it is home to many leading automobile makers of the country. Since the Information Technology (IT) revolution it has become a favoured destination for education and opportunities which has resulted in the high growth rate. The city is ecologically sensitive as it comprises the Guindy National Park, Pallikaranai marshes, rocky hillocks and water bodies like the Adyar Estuary, Buckingham canal, Coovum River which are rapidly disappearing due to intense land pressure.

The city has a good network of public transport in bus and train. The Metropolitan Transport Corporation (MTC) provides the bus transport with 3464 buses plying on 732 routes carrying over 5 million people every day. The suburban train and the Mass Rapid Transit System (MRTS ) network links the city's centre with its periphery and carries approximately 1 million people every day. As per the State Transport Authority records there are about 3.4 million registered vehicles in Chennai as of April 2011 of which over 2.5 million are two wheelers. Due to the tumultuous growth of private vehicles and narrow roads of the city the congestion has increased and the volume to capacity ratio of roads has increased to 1.2 times.

Public transport makes up for a little over 28% of the trips in the city while almost 33% of the trips are being made by walk. With the growing average trip length the **MTC TRANS** surveys have suggested that will increase the public transport trip share from its current state to about 55% once the becomes operational.

Considering the increasing fuel cost and traffic congestion the shift in rider-ship is expected to happen in near future provided the government takes stringent steps to reduce the number of private vehicles on the road and the cost to benefit ratio for the commuter is higher using the public transport. To lure more rider-ship the mode of public transport should be consistently reliable, accessible, safe, cost effective and equipped with facilities keeping the future in mind.



**Station Names and Chainage Km**

<b>MTC TRANS Route Plan And Station Location Measurement</b>				
No	Station Names	Area Names	Length	Chainage
0	Tamilan	Main Station Poonjeri Enterance	0	
1	Vinnavan	Paynoor	1.157	1.157
2	Thanigai	Karunguzhipallam	1.163	2.320
3	Thiruvoli	Paynoor Road	1.163	3.483
4	Atral	Omega City	1.203	4.686
5	Nagulan	Thandalam-1	1.164	5.850
6	Valan	Thandalam-2	1.142	6.992
7	Aalavandan	Thandalam-3	1.202	8.194
8	Nambi	Kakiyamman Kovil St	1.143	9.337
9	Gnanam	Thandalam Road	1.201	10.538
10	Cholan	Esser	1.103	11.641
11	ARUL	Thirupour Temple	1.116	12.757
12	Inban	Kanagapattu	1.225	13.982
13	Pachai	Ssn Colage	1.094	15.076
14	Anandam	Senganmal	1.131	16.207
15	Neelan	Ramalingapuram	1.117	17.324
16	Lingam	Madha Kovil St	1.076	18.400
17	Paari	Padur Road	1.165	19.565
18	Ponnadi	Padur Angalamman Kovil	1.079	20.644
19	Chemmal	Kannathur Reddy Kuppam	1.173	21.817
20	Ambalan	Kazhipathur	1.130	22.947
21	Vengai	Mettu St	1.107	24.054
22	Devaram	Eagttur Bus Stop	1.128	25.182
23	Ori	Navallur Main Road	1.177	26.359
24	Arunan	Semmancheri	1.130	27.483
25	Yaalvendan	Thiruvalluvar Salai	1.128	28.617
26	Seeralan	Kazhipattur	1.134	29.751
27	Vetri	Model School Road	1.108	30.859
28	Cheran	Karapakkam	1.161	32.020
29	Sidhan	Okkiyam Thuraipakkam	1.181	33.201
30	Ulagan	Gangai Amman Kovil St	1.144	34.345
31	Pavalan	Sakthi Nagar Main Road	1.125	35.470
32	Aadhavan	New India Colony Perungudi,	1.166	36.636
33	Paraman	Senthil Nagar Thuraipakkam	1.133	37.769
34	Kamban	Ramalinganagr	1.135	38.904





35	Deeran	Periyar Nagar	1.148	40.052
36	Total Km	40.052km		

**Traffic Survey**

The above table reflects the data arrived at the actual passenger movement (locals, students, office staffs, labors, tourists and all walks of life across the prescribed places by various modes of transport (buses, cars, two-wheelers...etc.)

**Passenger Carrying Capacity**

Passenger Carrying Capacity (@ 6 persons per square meter of standee area) for a single coach train will be approx. in the range of 50 people configuration and seating & standing capacity to be discussed with the car manufacturer during final design. Passenger cabin is moving elevated and side road also, inside the cabin wheel attachable provide, they can used in end of the station and change the guideway parking on depot use only.

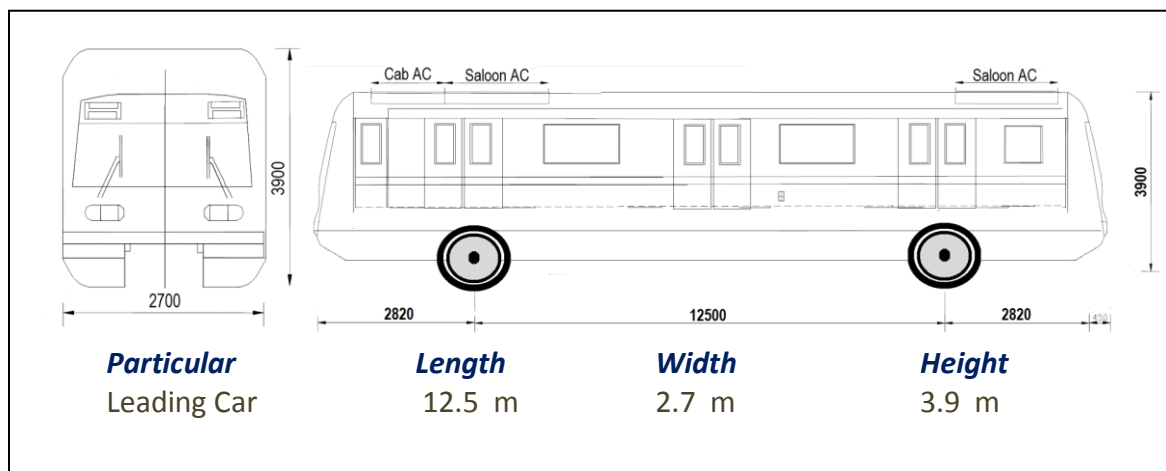

**Traffic demand**

The **MTC TRANS Rapid System Transit** peak hour peak direction passenger traffic PDPDT capacity for the year 2019 is estimated at 5500 in a two rail with headway of 5 minutes for the year 2016 is estimated at per hour two rail car.

**Train Operation Plan**

The following assumptions have been made in the preparation of Train operation Plan:

- Running of services for 17 hours per day (5.30 AM to 11.30) with a station dwell time of 30 seconds.
- Make up time of 5-10% with 8-12% coasting.
- Scheduled speed has been considered as 30 kmph.



- The Capacity can be varied by altering the rake composition or the headway.
- Based on the projected PHPDT demand, train operation has been planned taking the passenger capacity as 50 @ 6 persons per square meter of standee area for the year 2019, 2021, 2031 and 2041.

**Year 2019**

- 6 min Headway with single two rails coach , Available Peak Hour Peak Direction Capacity of 50 @ 6 persons per square meter of standee area.
- Available Peak Hour Peak Direction Capacity of 60 @ 8 persons per square meter of standee area under dense loading conditions.
- The maximum PHPDT demand of approximately 5500 is in the Section between ADYAR Stand
- Another PHPDT demand of approximately 6144 is in the Section between Bus Stand.
- With this planned PHPDT capacity, optimum utilization of Rolling Stock will be achieved and empty running of trains will be considerably reduced. However, the Rolling Stock is designed for carrying higher density loading @ approximately 8 standee passengers per square meter and in the sections in which PHPDT capacity exceeds the planned capacity, overloading during these periods will help in reducing the demand for increased deployment of Rolling Stock.

In future, the passengers regarding the PHPDT will be calculated depending upon the population increase in the future.

The PHPDT capacity provided in different years of operation is tabulated below:

**Capacity provided for MTC TRANS Mono Rail Transit System**

YEAR	2019	2021	2031	2041
Cars/trains	2	2	2	2
Headway (Minutes)	6.00	4.00	3.00	2.00
Max.PHPDT Demand	5500	6500	7200	10800

**Train frequency**

The train operation of MTC TRANS Rail Corridor provides for the following train frequency:

<b>2019</b>		<b>2021</b>		<b>2031</b>		<b>2041</b>	
Peak hour	lean hour	Peak hour	lean hour	Peak hour	lean hour	Peak hour	lean hour
6.00	10 to 30 min	4.00	8 to 20 Min	3.00	6 to 20 min	2.00	5 to 15 Min

No services are proposed between 00.00 hrs to 5.00 hrs. This period is reserved for maintenance of infrastructure and rolling stock.



### **Cost Estimate**

The estimated cost per coach at April '11-2016 Price level exclusive of taxes and duties may be assumed as INR 8 Crores per Coach. So, total 14 coaches are required in the year 2018 and the budget provision of INR 112 Crores is to be kept in the Estimate for Rolling Stock.

### **Braking System**

There are no wheels or brake shoes involved: An EDS system can provide both levitation and propulsion using an onboard linear motor. EMS systems can only levitate the train using the magnets onboard, not propel it forward. As such, vehicles need some other technology for propulsion. A linear motor (propulsion coils) mounted in the track is one solution. This linear motor operates to propel the train forward, and when it is necessary to stop the train, the linear motor acts in reverse. I can only guess that this reversing of the linear motor converts the energy of the train into electrical energy which is fed back into the electrical network. The major point is that there is no friction at all and no connection with the ground, so friction brakes are not possible. As far as I know the train is levitated even when stationary.

### **Interior and Passageway**

MTC TRANS Passenger capacity of a car is maximized in System by providing longitudinal seats for seating and utilizing the remaining space for standing passenger. Therefore all the equipments are mounted on the under frame for maximum space utilization. The interior is designed with the comfort and safety of passengers in mind. Hand rails and hand grips are placed within easy reach of all standing passenger. The number and location of the seats are selected to optimize the standing area for passengers.



The unobstructed passageways between cars are designed to give a wider space with easy and faster passenger movement from car to car and it also makes the train to train longitudinal evacuation possible in the event of emergency. Wider vestibules are provided to facilitate easy movement from one car to the other car.

### **Passenger Carrying Capacity**

In order to maximize the passenger carrying capacity, longitudinal seating arrangement shall be adopted. The whole train shall be vestibule to distribute the passenger evenly in all the coaches by providing wider vestibule.

Criteria for the calculation of standing passengers are 6 persons per sq m in crush state of peak hour. Depending upon the required passenger carrying capacity and car dimensions of specific supplier, following train composition is recommended: single coach Train:



Passenger Carrying Capacity (@ 6 persons per square meter of standee area) for a single coach train set (Indicative) will be approx 50 seating & standing capacity to be discussed with the car manufacturer during final design. Passenger Carrying Capacity (@ 8 persons per square meter of standee area) for a single coach train set (Indicative) will be & standing capacity to be discussed with the car manufacturer during final design.

### **Coach Design and Features of Rolling Stock**

The body shell will be in Aluminium so as to reduce the tare weight. Coaches will be fully air-conditioned with 2 doors on each side and with wide vestibules. Whether coaches will have single or bogie should be left to the manufacturers to achieve the most optimum power consumption, maintenance costs and manoeuvrability. Trains will be driverless but provision left for manual operations as well. Specifications in regard to noise levels inside and outside coaches, regeneration during braking, riding index etc are to be specified while inviting bids.

The important criteria for selection of rolling stock are as under:

- Proven equipment with high reliability.
- Passenger safety feature.
- Energy efficiency.
- Light weight equipment and coach body.
- Optimized scheduled speed.
- Aesthetically pleasing Interior and Exterior.
- Low Life cycle cost.
- Flexibility to meet increase in traffic demand.
- Anti-telescopic.

The controlling criteria are reliability, low energy consumption, lightweight and high efficiency leading to lower annualized cost of service. The coach should have high rate of acceleration and deceleration.

### **Passenger Doors**

For swift evacuation of the passenger in short dwell period, two doors of adequate width, on each side of the coach have been considered. These doors shall be of such dimensions and location that all the passenger inside the train are able to evacuate within least possible time without conflicting movement. As the alignment passes through elevated section above ground, automatic door closing mechanism is envisaged from consideration of passenger safety. Electrically controlled door operating mechanism shall be used. The door shall be of Bi- parting pocket sliding Type.





### ***Air-conditioning***

With heavy passenger loading of 6 persons/sqm for standee area and doors being closed from consideration of safety and with windows being sealed type to avoid transmission of noise, air conditioning of coaches has been considered essential. Each coach shall be provided with air conditioning units capable of cooling, heating and dehumidifying and thus automatically controlling interior temperature throughout the passenger area at 25°C with 65% RH all the times under varying ambient conditions up to full load. For emergency situations such as power failure or both AC failures etc, ventilation provision supplied from battery will be made. Provision shall be made to shut off the fresh air intake and re-circulate the internal air of the coach, during an emergency condition, such as fire outside the train causing excessive heat and smoke to be drawn in to the coach.

### ***Passenger Evacuation***

An emergency walk way in between two track beams at soffit level ensures safe passenger evacuation at any location along the alignment. This walk way will also help for the maintenance staff to reach a stranded train in the event of technical snags. Suitable ladders to be used by passengers for getting down to the emergency walk way will have to be stored in each coach

### ***Communication***

The cars are provided with continuous communication with base Operational Control Center and station control for easy monitoring of the individual train in all sections at all the time . Public Address and Passenger Information Display System is provided in the car so that passengers are continuously advised of the next stoppage station, final destination station, interchange station, emergency situations if any, and other messages. The rolling stock is provided with Talk Back Units inside the cars, which permit conversation between passengers and OCC in case of any emergency.

### ***Noise and Vibration***

The trains will pass through heavily populated urban area. The noise and vibration is an important criterion from public acceptance view point. The source of noise is aerodynamics noise generated from equipment like Blower, Compressor, air conditioner, door, Inverter etc.

- Maglev vehicles make no wheel or engine noise and very little wind noise at speeds suitable for urban transportation.
- Provision of skirt throughout the car encapsulating complete under frame.
- Provision of anti drumming floor and noise absorption material.
- Low noising air conditioner.
- Mounting of under frame equipments on anti-vibration pad
- Smooth and gradual control of door.



- Provision of sound absorbing material in the supply duct and return grill of air conditioner.
- Sealing design to reduce the aspiration of noise through the gap in the sliding doors and piping holes. The lower vibration level should be achieved with the provision of suitable secondary suspension.

### **Passenger Safety Features**

#### **CBTC based driverless control**

The rolling stock is provided suitable arrangements in accordance with international standards to ensure absolute safety in the train operation. It is an accepted fact that 60-70% of the accidents take place on account of human error. Adoption of driverless eliminates the possibility of human error. However suitable arrangements to be provided for control by a trained personal during contingencies.

#### **Fire**

The rolling stock is provided with fire retarding materials having low fire load, low heat release rate, low smoke and toxicity inside the cars. The electric cables used are also normally low smoke zero halogen type which ensures passenger safety in case of fire. Material used in the cars shall conform to fire safety requirement of NFPA 130 and ASTM-E-119 Standards or the latest edition of other equivalent international standards applicable for maglev trans .

#### **Crash worthiness features**

Initially the project kicks off with a single car only, if there is going to be additional card included then the rolling stock is provided with inter car couplers having crash worthiness feature which reduces the severity of injury to the passengers in case of accidents. This feature (adding more cars) will be practically implemented depending upon the passenger traffic.

#### **Passageway**

The unobstructed passageways between cars are designed to provide adequate space for movement of wheel chair and easy and faster passenger movement from car to car.

#### **Possible Suppliers**

Light rail system manufactured by these suppliers worldwide:

Hitachi, Japan, Bombardier, Transportation, Germany, Siemens. Different variants of rails are being manufactured for varied operational demands and specific requirements. However the car dimensions for each manufacturer is fixed and any change would lead to increased cost. Hitachi/Japan is the oldest manufacturer of different types of light rails. The cars are with double axel bogie with both the axles as motorized axles.



The car body and under frame is manufactured with Aluminum extrusion with hollow truss to save weight. Car length varies from 9.20meters. Car body is of Aluminum while under frame is of stainless steel.

**Future Additions**

Since platform lengths are fixed no further addition to the train length is envisaged. System capacity can be increased by reducing the headway. The CBTC system of signalling permits running of trains every 2 minutes which can give a capacity of 15750 PHPDT. This is considered enough for CHENNAI city for all time to come. The salient features of the proposed Rolling Stock are enclosed as Attachment-I

**The power plant**

The power plant is to be set up in 100acres will be allotted for power plant to install the solar panels to generate the necessary 20 MWDC power required for the system. 2 acres will be allotted for the depot. Backup generators and other necessary utilities will fill the area of the power plant.

The 20 acres area is to be provided by the Tamil Nadu government possibly near around 500 meters away from them.

**PREFABRACTION OF INDIVIDUAL COMPONENTS**

1. Magnetic the drive units in separate prefabrication are coupled, respectively, above the cabins
2. Which can be disconnected simultaneously for the stationary operation
3. Docked for the hanging operation again
4. So there is one way only one drive unit
5. The cabin units (terminal units +central parts +special parts etc) are therefore prefabricated without the magnetic –drive units.
6. When starting up the magnetic drive units, these are coupled respectively above the cabins

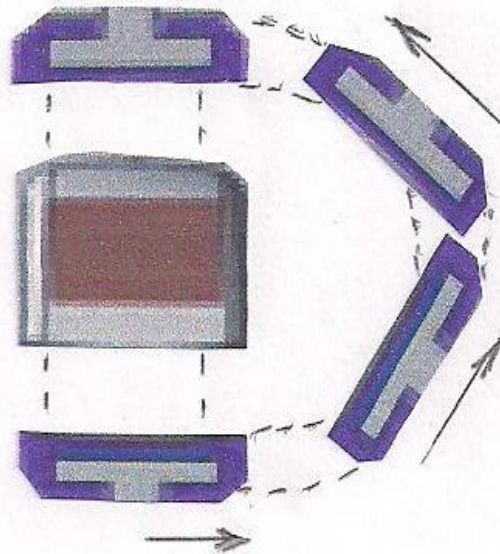



## **12 -THE DEPOT**

The Depot is located over a hectare land near Mahabalipuram at Poonjeri Village; hardly 500 meters for both setting up the Power plant and the Depot will have facilities for stabling the trains overnight, inspection facilities and workshop facilities. The operation central centre (OCC) is located in the Car (rail car) depot.

All inspection lines, workshop lines are designed to accommodate a single car at ground level itself. All inspection works under the rail car will be carried out from the basement level itself, thereby reducing the cost.

Single cabin to accommodate at ground level with wheel support, if connect to lines the coach will be support of lift.

All Stabling lines are designed to accommodate a single rail car each(In future it may be increased depending on the needs). So to accommodate a single rail car it will be 12.5 meters.

### ***Maintenance features @ the Depot***

The main components of the maintenance depot will have:

- Workshop and heavy cleaning shed for the Rolling Stock.
- Operational and functional safety requirements.
- Ancillary buildings for other maintenance facilities.
- Electrical & Mechanical Services, power supply and distribution system.
- Water Supplies, Drainage & Sewerage.

### ***Inspection requirements at depot***

Facilities for carrying out inspection activities shall be provided in the inspection bay for following Systems / Equipments of a train:

- Electronics; PA/PIS
- Mechanical components, couplers etc
- Batteries
- Air conditioner
- Brake modules
- Bogie
- Traction Motor
- Vehicle doors, windows and internal fittings
- Power system including converter, circuit breaker etc.
- Current Collector etc.





- These activities shall be grouped into “A” checks and “B” checks. The minor scheduled Inspections (“A” checks) shall be carried out during the day off peak and night. Since “B” checks take longer time, these cannot be completed in the off peak times. For “B” checks, separate line can be nominated where the rakes may be kept for longer time.

Another Inspection line can be used for minor repairs and for adjustment and testing after the IOH and POH.

### ***Design of Depot- cum- Workshop Facilities***

#### ***Stabling lines at depot:***

For the design of the stabling lines in the depot and terminal stations or elsewhere (as may be required), following approximates lengths have been taken in consideration:

#### ***Inspection Bay at Depot-Cum-Workshop***

##### ***Length of Inspection Bay***

Following approximates length have been taken in consideration for the design of the

##### ***Width of the Inspection Bay***

The width of the Inspection bay in computed as below:

Roof Inspection platforms and walkways for roof inspection supported on the columns shall be provided. Further, 5m cross pathways are left at each end for movement of material by fork lifter/Leister/Hand trolley. Power supply and Pneumatic supply shall also be made available on each inspection shed columns. Air-circulators shall be provided on each column. The inspection bay shall be provided with EOT crane to facilitate lifting of equipment. Roof and walls shall be of such design that optimum natural air ventilation occurs all the time and sufficient natural light is also available. Each Inspection bay will also have arrangement close by for cleaning of HVAC filter under high pressure water jet.

#### ***Workshop Shed***

(a) There shall be one bay comprising of two lines each. Size of the workshop bay is proposed to be size of train. The unscheduled lifting and heavy repair line shall be fitted with jack system capable to lift the car unit simultaneously for quick change of bogie, thereby saving down time of Rolling Stock. The arrangement of jack system shall be such that lifting of any coach in train formation for replacement of bogie/equipments is also individually possible. Each workshop bay shall be equipped with two overhead cranes, each spanning the entire length of the workshop bay.



(b) There shall be provided space for repairs of HVAC, Door, and Traction motor etc. repairs. Distinct spaces shall be earmarked for dismantling/repairs/ assembling and testing of each of these equipments. Related machinery for Overhauling / Repairs & testing activities of every equipment are also to be housed in the space earmarked.

(c) There shall be washing and cleaning equipments on the workshop floor. Suitable bogie test stand shall be provided in the workshop. Other heavy machinery shall also be suitably installed on the workshop floor. Air-circulators, lights, Powers supply points and compressed air supply line shall be provided on each workshop column.

(d) There shall be walkways on columns for roof inspections, along the workshop lines. These walkways shall not infringe with cars being lifted/ lowered by means of mobile jacks. Suitable space between the nearest exterior of a car and farthest edge of the walkway has to be ensured to avoid conflict in lifting and lowering of cars.

(e) The small component, bogie painting and battery maintenance cells will be located in the workshop with arrangement that fumes are extracted by suitable exhaust systems.

(f) Workshop will have service building with array of rooms along its length. These can be made by column and beam structure and architecture made of brick works. These shall cater for overhauling sections, offices, costly store item, locker rooms, toilets etc. Two opposite sides width wise shall be open to facilitate natural air circulation and cross ventilation besides the egress & ingress for coaches. The sidewalls shall also have sufficient width of louvers for providing adequate ventilation.

(g) There shall be space for bogie/ axle repair shop with necessary infrastructure for disassembly, overhead, assembly and testing of mechanical components of bogies/ axle. The repair shop shall be easily approachable from with the workshop for transportation of components.

***Following equipment repair/overhaul facilities are planned in the workshop***

- Body furnishing
- Bogie
- Traction Motors
- Axle Box and Axle Bearing
- Inverter, High Speed Circuit Breaker
- Battery
- Air Compressor



- Air-conditioner
- Brake Equipment
- Door actuators
- Control and measuring equipments
- Pneumatic/Hydraulic equipment
- Dampers and Springs
- Couplers/Gangways
- Coach Painting

### ***Minimum carriageway width***

Minimum carriageway width on the roadway at ground level during the entire period of construction shall be maintained on ground level pillar in the Depot at where the service staff can easily walk and work on the cabins.

### ***Traction Supply Arrangements in Depot***

In order to prevent leakage of return current to Depot area, and to ensure uninterrupted power supply to Depot in non revenue hours when power block is availed on the main line, Depot traction supply shall be isolated from main and on-line equipment rooms. Cable route diversification shall be provided. Line supply by providing a separate traction sub-station for Depot area. Tracks of Depot area shall be isolated from main line through insulated rail joints. Remote controlled sectionalizing switches shall be provided to feed power from Depot TSS to mainline and vice versa in case of failure of TSS. Track Earthing Panels (TEP) shall be provided at suitable locations in case the rail potential exceeds the prescribed limit of highest touch potential in Depot, which is 60V as per EN 50122-1. In areas where leaky conditions exist, (eg. washing lines, pit wheel lathe, etc.) insulated rail joints shall be provided with power diodes or equivalent devices to bridge the insulated rail joint to facilitate passage of return current. Stringer type/750V DC current collection system shall be provided in all Depots/workshops. Traction Return Circuit The running rails shall be connected to the common Traction Power System Neutral at each traction sub-station to provide the traction current return path. To limit the extent of conducted EMI, electrical connections with the guideway infrastructure metal reinforcements shall be connected to an Earth drain-wire

### ***Car Delivery Area***

There shall be connectivity between the Depot-cum- Workshop and mainline and all trains due for scheduled/ unscheduled works shall reach the depot-cum- Workshop by rail.

However in case of newly procured coaches, which are transported by road, these shall reach the Depot-cum Workshop by the road on trailers. To unload the coaches and bring them to the



beam, provision of space, along the side of shunting neck, has to be made for unloading of cars and other heavy materials. This area should be facilitating with the movement of road trawler, which brings in the cars. There should be enough space available for movement of heavy cranes for lifting of coaches. The unloading area should be easily accessible for heavy duty hydraulic trailers.

**Depot Equipment**

Emergency vehicles capable of working under ATP shall be provided in Depots for faster and efficient response in the event of breakdown of power supply.

**Operational Features**

The rake induction and withdrawal to main line will be primarily from the stabling shed. Further, provisions are preferred for direct rake induction and withdrawal to main line from Inspection Shed/workshop area. Movement from depot to the main line shall be planned that the headway of main line is not affected. The stabling lines would be interlocked with the main line thereby induction of train from the stabling would be safe and without loss of time. The proposition for a transfer beam on the incoming line as well as on the outgoing line to facilitate the movement of rake in the depot by Operation Control Centre (OCC) even though the further path inside the depot is not clear shall be explored in the detailed design stage depending on the actual availability of land. An emergency line is also provided from which an emergency rescue vehicle may be dispatched to main line in the event of emergency if necessary.

**Staff Quarters**

It is necessary to provide residential accommodation to certain categories of essential and breakdown staff for which a lump sum provision of Rs.20.0 crores has been kept.

**Rake Requirement**

Based on Train formation and headway as decided above to meet Peak Hour Peak Direction Traffic Demand, Rake requirements has been calculated and tabulated below.

YEAR	2019	2021	2031	2041
Head way(Min)	6Min	4 Min	3 Min	2 Min
No. of train car	2	2	2	

**Rolling Stock Maintenance Needs**

**Maintenance Schedule**

The following maintenance schedule has been envisaged for conceptual design of depots assuming approx. 2856 per running per train per day, taking in consideration of the passenger load.



<b>Type of Schedule</b>	<b>Interval</b>	<b>Work Content</b>	<b>Locations</b>
Daily	Daily	Check on the train condition and function at every daily service completion. Interval cleaning/mopping of floor and walls with vacuum cleaner.	Stabling Lines
“A”Service Check	5,000 Km (approx. 15 days)	Detailed inspection and testing of sub - systems, under frame, replacement/ topping up of oils & lubricants.	Inspection Bays
“B”Service Check	15,000 Km (approx. 45 days)	Detailed Inspection of ‘A’ type tasks plus items at multiples of 15,000 Km (‘B’ type tasks)	Inspection Bays
Intermediate Overhaul (IOH)	420,000 Km, (3and half Years approx.)	Check and testing of all sub-assemblies (Electrical + Mechanical). Overhaul of pneumatic valves, Compressor. Condition based maintenance of sub-systems to bring them to original condition. Replacement of parts and rectification, trial run.	Workshop
Periodical Overhaul (POH)	840,000Km, (7 Years approx.)	Dismantling of all sub-assemblies, rail car, traction motor, gear, control equipment, air-conditioning units etc. Overhauling to bring them to original condition. Checking repair and replacement as necessary. Inspection and trial.	Workshop
Heavy Repairs	-	Changing of heavy item such as cars, traction motor, axles, gear cases & axle boxes etc.	Workshop

The above Schedule may need slight revision based on the actual earned kilometers per train and the specific maintenance requirements of Rolling Stock finally procured.





**Washing Needs of Rolling Stock**

Cleanliness of the trains is essential. Following schedules are recommended for Indian environment

**Requirement for MTC TRANS rapid transit system**

YEAR	2019	2021	2031	2041
Head way (Min)	6.00	4.00	3.00	2
Total No. of cars	24	24	30	30

**Rolling Stock requirement in TOP is tabulated below:**

S.N.	Kind Inspection	Maint. Cycle	Time	Maintenance Place
1.	Outside cleaning (wet washing on automatic washing plant)	3 Days	10 mins.	SinglePass through Automatic washing plant of Depot
2.	Outside heavy Cleaning (wet washing on automatic washing plant and Front Face, Vestibule/Buffer area.Floor, walls inside/outside of cars and roof. Manually)	30 days	2 – 3 hrs.	Automatic washing plant & cleaning & washing shed

**Rail car**

**Following Safety Features Should Be Incorporated In the Design of the Maintenance Depot-Cum-Workshop**

- EOT cranes in the inspection bay should be interlocked with 750V dc in such a way that, the cranes become operational only when the Power supply is isolated and grounded.
- Red flasher lights should be installed along the inspection lines at conspicuous location to indicate the DC power supply system is 'Live'.
- TM stacking arrangement should be an inbuilt feature at the end of Workshop Lines.
- Pillars in the inspection bay & workshop should have provision for power sockets.
- Placement of rakes from inspection/workshop lines on to washing lines for interior cleaning on their own power should be possible. Linking DC power supply system its isolation at the cleaning area should be provided. Necessary requirements of safety should be kept in view.
- The roof inspection platform should have open-able doors to facilitate staff to go up the roof for cleaning of roof. Suitable safety interlock should be provided to ensure maintenance staff are enabled to climb on the roof inspection platform only after the DC power supply system is isolated.



- Control Centre, PPIO & store depot must be close to Workshop.
- Width of the doors of the sections wherein repairs of equipments are done should be at least 2 meters wide to allow free passage of equipment through them.
- Provision of water hydrants should be done in workshops & stabling yards also.
- Compressed air points along with water taps should be available in interior of buildings for cleaning.
- Ventilation arrangement inside the inspection shed and workshop should be ensured.

Arrangement for natural cross ventilation from one side to another of inspection & workshop bays to be incorporated along with optimum availability of natural light at floor level.

**Plant and Machinery**

The Plant and Machinery should be provided suitable for MTC TRANS .

<b>Schedule Of Depot Equipment</b>		
No.	Items	Q'ty
1	Scissor Lift	2 units
2	Scissor Lift	2 units
3	Notebook PC Type Plug-in Diagnostic ATC/TD Testing Equipment	1 set
4	Notebook PC Type Plug-in Diagnostic VVVF Testing Equipment	1 set
5	Notebook PC Type Plug-in Diagnostic Brake Control Testing Equipment	1 set
6	Stepladder	8 pcs
7	Bogie Drop	1 unit
8	Overhead Traveling Crane	1 unit
9	Car body Support Stand	1 set
10	Tyre Changer	1 unit
11	Hoisting Tool for Running Tyre (Tyre Lifting Jig)	1 set
12	Temporary Bogie	1 set
13	Nitrogen Gas Cylinder Setting Frame	1 set
14	Traverser	1 unit
15	Automatic Car Body Wash Plant	1 unit
16	Overhead Travelling Crane	2 units
17	Car Body Lifting Jib	2 sets
18	Car Body Stand	16 units



19	Bogie Lifting Beam	1	unit
20	Wheel Centre Dismantling Jig	1	unit
21	Axle Bearing Dismantling Jig	1	unit
22	TD Coupling Centering Tool	1	unit
23	TD Coupling Dismantling Jig	1	unit
24	Guide/Stabling Tyre Changer	1	unit
25	Bogie Lifting Jig	1	unit
26	Magnetic Flaw Detector	1	unit
27	Hydraulic Press Brake	1	unit
28	Shrinkage Fitting Device	1	sets
29	Traction Motor Disassembling Jig	1	unit
30	Traction Motor Testing Stand	1	unit
31	Air Brake Testing Stand	1	unit
32	Ultrasonic Cleaning Unit	1	unit
33	Train Vibration Measurement Device	1	set
34	Noise Meter	1	set
35	VVVF Test Bench	1	set
36	Air Compressor Facility	1	unit

### Infrastructure Facilities

#### Stabling Lines in Depot

- A part of the stabling siding in the depot shall be covered with a roof in order to
- facilitate testing of air conditioning of trains and their pre-cooling under controlled condition of temperature.
- Separate toilets adjustment to stabling lines shall be provided with small room for keeping cleaning aids and for utilization by the working staff.

#### Automatic Coach Washing Plant (AWP)

Provision to be made for Rolling Stock exterior surfaces to be washed using a fully automated Train Washing System, with a throughput capacity of approximately ten trains per hour. The AWP shall be situated at such a convenient point on the incoming route so that incoming trains can be washed before entry to the depot and undesirable movement/shunting over ingress and egress routes within the depot is avoided. Additional space for plant room for AWP system shall be earmarked.



### **Train Operators Booking Office**

Suitable office facility adjacent to the stabling lines at each depot should be provided so that the train operators reporting 'On' duty or going 'Off' duty can obtain updates regarding 'Special Notices', 'Safety Circulars' and other technical updates/information in vogue. These offices should have an attached a cycle/scooter/car stand facility for convenience of the train operating staff.

### **Test Beam**

A test beam in length duly fenced should be provided beside workshop in the depot. It shall be equipped with signalling equipments. It shall be used for the commissioning of the new trains, their trials and testing of the trains after the IOH and POH. Entry into the test beam shall be planned for a car train. In compliance to safety norms, the boundary of the beam shall be completely fenced to prevent unauthorized trespassing across or along the beam.

### **Heavy Cleaning Shed**

Heavy cleaning shed for cleaning of interior walls, floors, seats, windows glasses etc, outside heavy cleaning, Front/rear Face, Vestibule/ Buffer area, outside walls and roof. A line adjacent to inspection shed should be so provided that placement of rakes is possible from workshop or inspection lines & vice – versa conveniently and with ease.

### **Power Supply**

Auxiliary substations are planned for catering to the power supply requirement of the whole depot and workshop. Details of connected load feeder shall be worked out. Taking diversity factor of 0.5 the maximum demands shall be computed. Two Auxiliary substations are proposed, as the demand by machines in Workshop area would be very large. The standby power supply is proposed through DG set with AMF panel. The capacity of DG set will be adequate to supply all essential loads without over loading.

### **Compressed Air Supply**

Silent type compressor units shall be suitably installed inside the depots at convenient location for the supply of compressed air to workshop and Inspection sheds. Thus, the pneumatic pipeline shall run within the workshop and inspection bays as to have compressed air supply line at all convenient points.

### **Water Supply, Sewerage and Drainage Works**

In house facilities shall be developed for the water supply of each depot. Sewerage, storm water drainage shall be given due care while designing the depots for efficient system functioning. Past records of Municipal Corporation shall be used to design the drainage system. Rainwater harvesting would be given due emphases to charge the underground reserves.



### **Ancillary Workshop**

Arrangement for repairs of Shunters and other ancillary vehicles will be provided. These vehicles will also be housed here itself. Heavy lifting works can be carried out in main workshop. Ancillary workshop will be used for storing parts and their maintenance/ repair for restoration of 750 V dc feed system.

### **Watch Towers**

There shall be provision of adequate number of watchtowers for the vigilance of depot boundary.

### **Administrative Building**

An administrative building close to the main entrance is planned. It can be suitably sized and architecturally designed at the detailed design stage. A time and security office is also provided close to main entrance. It shall be equipped with suitable Access control system for all the staff working in the complex.

### **Parking Facilities**

Ample parking space shall be provided for the two wheelers and four wheelers at the following points.

- Close to the depot entry.
- Close to the stabling lines.
- Close to the Workshop/IBL.
- Space for parking of road and re-railing equipments.

Enough space for parking of road vehicle/ trailers/ trucks etc. Enough space will also have to be earmarked adjacent to workshops. Similarly, provision of space for parking of re-railing equipments will have to be made close to the main exit gate of the Depot.

### **Shed and Buildings**

The shed and buildings should be provided in the depot with their sizes and brief functions suitable for Maglev Magnetic Double Decker Rapid Transit. At the detailed design stage depending upon the land availability, the decision to locate these buildings can be taken. These can then be architecturally and functionally grouped.





**Salient Features Of Rail Rolling Stock For**

Features Of Rail Rolling Stock For <b>MTC TRANS Rapid Transit System</b>		
S.No.	Parameter	Details
1	Traction system	
1.1	Voltage	750 V dc
1.2	Method of current collection	+ve and -ve dc rails
2	Train composition	
2.1	Single Car	Two rail Car only
3	Car Body and under frame	Aluminum car body with stainless steel/ corrosion resistance steel under frame
4	Coach Dimensions	
4.1	Width	upto 2.7 m
4.2	Height	upto 3.9 m
4.3	Length	upto 12.50 m
5	Designed - Passenger Loading	120
6	Carrying capacity (Indicative)	
6.1	Two Car train sets (@ 6 persons per square meter of standee area)6*32sq=	Seating capacity: 50. Standing capacity: 100.
6.2	Single car train (@ 8 persons per square meter of standee area)	Approx. 60 depending upon car configuration and seating & standing capacity to be discussed with the car manufacturer during final design
7	Axle load(T)(@ 8 persons per sqm of standee area)	System should be designed for 12.5T axle load
8	Speed	
8.1	Maximum Design Speed	4500 Kmph
8.2	Maximum Operating Speed	30-80 Kmph
9	Noise Limits (ISO 3381 and 3095 - 2005)	
9.1	Stationary	
9.1.1	Internal (1.4 m above floor, along centre line)	68 dB(A)
9.1.2	External (7.5 m from centre line on the axle centre line height)	67 dB(A)



9.2.1	Internal (1.4 m above floor, along centre line)	72 dB(A)
10	Acceleration on level tangent track	1.0 m/sec <sup>2</sup>
11	Deceleration on level tangent track	1.2 m/sec <sup>2</sup> ( not less than 1.3 m/sec <sup>2</sup> during emergency)
12	Secondary Suspension springs	Air
13	Coupler	
14	Detrainment Door	Front / side
15	Type of Doors	Pocket type
16	Passenger Seats	Longitude seat & cushioned
17	Inverter & SIV	Self/Forced
18	TM	Self ventilated / suitable cooling
19	Control System	Train based Monitor & Control System (TCMS/TIMS)
20	Traction Motors	3 phase VVVF controlled/ Rotary Permanent Magnet Motor
21	HVAC	Cooling, Heating & Humidifier (As required)
22	PA/PIS including PSSS (CCTV)	Required
23	Passenger Surveillance	Required
24	Battery	Storage Battery
25	Headlight type	LED
26	Maximum gradient	6%
27	Minimum Horizontal Curve Radius	50m



## 13 - PILLARS

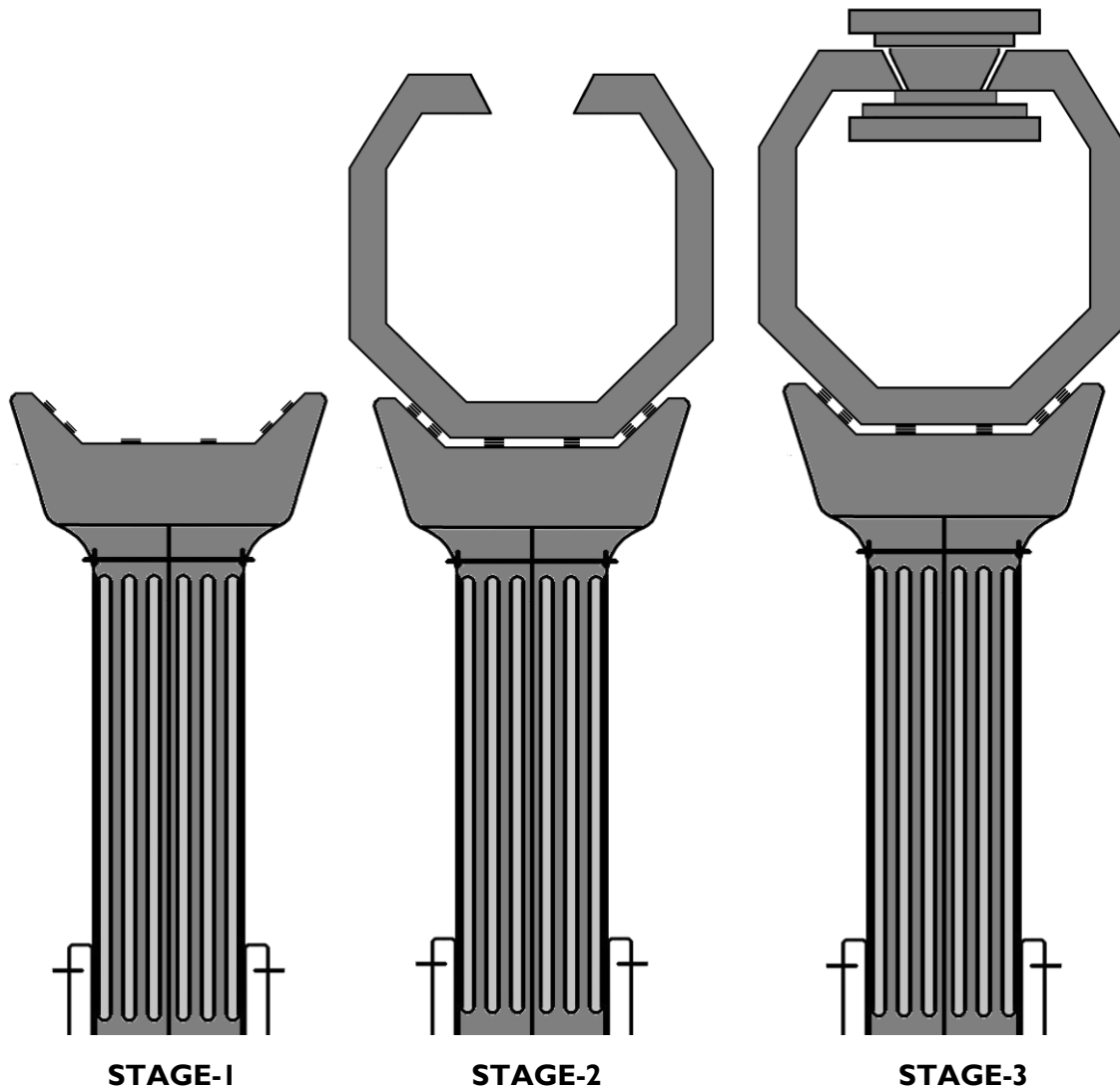

### IAT –MAGLEV MAGNETIC DOUBLE DECKER SYSTEMATIC PILLARS DESIGN

#### *Planning and Design parameters*

With EMS designs the vehicles must either be supported by an overhead rail or use a type of construction with the vehicle wrapped around the beam and magnets moving under the suspension rails the design parameters related to the MTC TRANS system described herewith have been worked out based on a detailed evaluation, experience and internationally accepted practices. Various alternatives were considered for most of these parameters but the best-suited ones have been adopted for the System as a whole.



## General

The entire stretch of alignment is elevated, carried on single pillars generally located along the median of the road at the Mamallapuram to Thiruvanmiyur Bus Stand road Entrance of the whole route no 1680 pillars in median of the road.

## Concrete Pillars

The columns will be 1" (meter) square concrete with steel pillars erected generally on piled foundations at approximately 15 meter centers generally in the median strips. Based on the geometry of the road at certain locations cantilever piers are found necessary and at some locations the metal guideway track are carried over portals the track beams which are hollow in the centre portion. As a general rule there are few services in these median strips, hence minimal changes to existing infrastructure will be required with the resultant cost and time benefits. The minimum clearance under the track will be 10 meters.

## Horizontal Alignment

For the MMDDRTS system with a maximum speed of 40 to 470 kmph, minimum Horizontal curve radius of 30 m is considered desirable with allowable Cant (Ca) = 7.33 % and cant deficiency (Cd) = 5.67 %. However, such radius is not achievable on the proposed corridor. At certain locations, radius of 50 m may also require due to existing road geometric. At such locations reduction in permissible speed will be necessitated.

## Horizontal Curves

- Desirable Minimum curve radius in mid-section : 40 m
- Absolute Minimum curve radius in mid-section : 30 m
- Permissible cant (Ca) : 7.33 %
- Cant deficiency (Cd) : 5.67 %

## Transition Curves

- Desirable length of Transitions of Horizontal Curves : 6.599 Ca/Cd (Whichever is more) (Ca/Cd in %age)
- Minimum length of transition curves : 15 m
- Minimum straight length between two Transition Curves : 15 m or NIL
- Minimum curve length between two Transition Curves : 15 m or Nil
- Curve Overlap between transition curves and vertical curves are permitted but will require casting/fabrication of beam to required profile. However, it may not be possible to provide a transition curve of desirable length due to constraints of circular curve length or otherwise. At such locations the permissible speed may be restricted due to comfort parameter.



## Elevated Sections

The guideway on Elevated Section should be such that a vertical clearance of 15m above road level is maintained. Actual guideway top level shall depend on type of structure adopted. The reinforced concrete guideway structure will hold the box type pillar.

## Track Centre

Minimum distance from the centre of the reinforced concrete guide (track) and the wall of the guideway shall be 2.2 m.

## Cantilevered columns

The MTC TRANS guideway or running surface will be suspended by any desired means, such as portals, columns or cantilevered columns, ceilings of building, suspending beams, or girders as is typical suspension methods

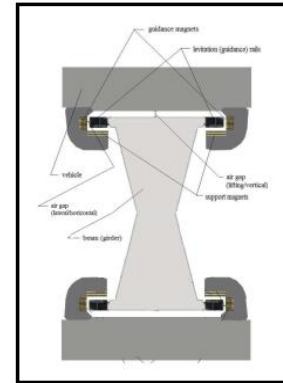

The guideway is the structure that maglev vehicles move over it and are supported and guided by it. Its main roles are: to direct the movement of the vehicle, to support the vehicle load, and to transfer the load to the ground. It is the function of the guideway structure to endure applied loads from the vehicle and transfer them to the foundations. Maglev suspension systems are divided into two groups of Electromagnetic Suspension (EMS) and Electrodynamic Suspension (EDS). There are varieties of vehicles that are manufactured based on these two types of systems. Vehicle path in EMS and EDS systems are called guideway and track, respectively. Basically, there are two main elements in a maglev system including its vehicle and the guideway. The three primary functions in maglev technology are levitation, propulsion, and guidance. Magnetic forces perform all of these. Magnets are used to generate such magnetic forces. For EMS systems, these magnets are located within the vehicle while for EDS systems magnets are located in the track. Performance of EMS system is based on attractive magnetic forces, while EDS system works with repulsive magnetic forces. In EDS system, the vehicle is levitated about 1 to 10 cm above the track using repulsive forces as presented In EMS system, the vehicle is levitated about 1 to 2 cm above the guideway using attractive forces as presented In EMS system, the electromagnets on the vehicle interact with and are attracted to levitation rails on the guideway.

Electromagnets attached to the vehicle are directed up toward the guideway, which levitates the vehicle above the guideway and keeps the vehicle levitated. Control of allowed air gaps between the guideway and vehicle is achieved by using highly advanced control systems the components of the guideway and track including levitation and guidance systems in the mentioned maglev systems.





Upon entering a curve at the appropriate speed, centrifugal force can hold the body outwards from the track by  $10^\circ$  in addition to the  $10^\circ$  of super-elevation, so that effectively the body can be swung out to a total  $20^\circ$ . Guideway provides guidance for the movement of the vehicle, to support the vehicle load, and to transfer the load to the ground. In maglev guideways contrary to traditional railroad tracks, there is no need to ballast, sleeper, rail pad and rail fastenings to stabilize the rail gauge. A guideway consists of a beam (girder) and two levitation (guidance) rails. Guideways can be constructed at grade (ground-level) or elevated including columns with concrete, steel or hybrid beams. Maglev elevated guideways minimize land occupation and prevent collision with other forms of traffic at-grade intersections.

In recent years, with increasing traveling speed of the rail systems, aerodynamic load problems became very important. From the system point of view, aerodynamically topics which affect and define the interface between rolling stock, infrastructure and operation are of paramount importance and the corresponding loads increase with the vehicle speed. If maglev vehicles pass in close proximity to each other or move close to fixed objects such as barriers or buildings, the aerodynamic interactions can produce significant loads on the vehicle or the fixed object. The magnitude and duration of the load depends on the velocity and geometry of the vehicles and also on the ambient wind speed and direction.

Longitudinal force can be applied to the guideway through braking and acceleration of the vehicle, vehicle weight when the guideway has a longitudinal slope, and air pressure(aerodynamics). Since maglev vehicles have no wheels, axles and transmission, they weigh less than a conventional railroad train. The lack of wheels also means that there is no friction between the vehicle and the guideway. These factors result in a reduction in energy consumption. Therefore, the vehicle requires a lesser force for braking and stopping it.

Magnetic levitation is caused by magnetic forces that transmit to guideway by maglev vehicle. In fact, these forces are the consequence of interactions between vehicle and guideway caused by magnets. For EMS systems, these magnets are installed within the vehicle. The forces are of attractive magnetic forces. Lifting magnetic forces due to interaction of guideway and support magnets cause the levitation of the vehicle. Support magnets are located on both sides along the entire length of the vehicle. The attractive force produces inherently unstable vehicle support because the attractive force increases as the vehicle/guideway gap decreases.

### **Design of Guideway**

Guideways are designed and constructed with concrete or steel girders. Concrete guideway girders can be as reinforced or pre-stressed. Guideway girder is evaluated for different load cases. As example, the Shanghai guideway girder was evaluated with respect to as many as 14,000 load cases by consideration of the deflection, dynamic strength and thermal expansion.



The most important task or essential aim when designing the alignment is to specify the geometry of the guideway's functional planes so that the passenger travelling in the vehicle on the guideway experiences optimum comfort during the journey. The geometry defines the limit values for accelerations in the three spatial directions (X, Y, and Z direction). However, apart from the acceleration, the consideration of the change in acceleration (jerk) is also an important aspect for comfort. Therefore, various mathematical formulae were discussed for the transition curves and lengths, with the result,

- the horizontal transition curves are designed as sinusoidal curves and,
- The vertical transition curves are designed as clothoids. An exception are the track switching devices which is based on beam theory,
- Designed using clothoids for the horizontal transition curves in the turn-out position. The alignment is designed and the space curve established taking into consideration the aspects given above as well as the system characteristics, e.g
- climbing capability up to 10% and
- Can't (super elevation) in curves up to 12%.
- The fact that maglev do not touch the guideway also has other advantages: faster acceleration and braking; greater climbing capability; enhanced operation in heavy rain, snow, and ice; and reduced noise. Maglev systems are also energy-efficient on routes of several hundred kilometers' length; they use about half as much energy per passenger as a typical commercial aircraft. Like other electrical transport systems, they also reduce the use of oil, and pollute the air less than aircraft, diesel locomotives, and cars.

The space curve data are used in the next design phase as the design criteria for,

- specifying the substructures,
- Height of the columns,
- Geometry of each individual beam,
- Location of the track switching devices and for the precise location of the functional components on the beam.

The reductions in speed in the track course result from slopes, where the residual acceleration abilities do not maintain a high speed. Based on faster acceleration, the operation speed of the maglev can be smaller than that of the ICE3 in order to achieve the same running time. The primary energy demand that is relevant for the comparison between different means of transport averages under the examination of the current power mix as 2.5 times the secondary needs.

### **Safety life-cycle**

The risk analysis pertaining to the safety concept for maglev vehicles, which is a keydocument, is an important criterion in the implementation process for the entire project in accordance with the DIN EN 50 126 life-cycle model, The European railway lifecycle standard DIN EN 50126 defines a process, based on the system life-cycle including RAMS management.



It is applicable to modifications of existing systems in operation prior to the creation of the standard, although it is not generally applicable to other aspects of the existing system. An OCS may only be approved by the safety authority and accepted by the maglev transport authority if both the generic subsystem and the corresponding application data have successfully passed the safety life-cycle, including.

1. Verification - to determine by analysis and test that the output of each life-cycle phase meets the requirements of the previous phase
2. Validation - to demonstrate by analysis and test that the system meets in all respects its specified requirements
3. Safety assessment.

With a typical spring effect, a restoring force is created, tending to return the body to a neutral position as described with reference again to. This may not be desirable. As a result, embodiments of the present invention provide for a change in lengths of the suspension member without developing restoring forces. The weight of the body is carried below, while presenting equal distribution of loading. This allows the body to swing freely outwards solely under the gravitational and centrifugal forces.

This transverse movement or tilt may be augmented by adding a force to stimulate the tilting motion early as in a tilt train mechanism in the case where curves do not allow a long enough transition segment. The assembly of the car body 20 and the carrying vehicle 72 together allows the center of rotation for the outward swing to be located at the highest point above the center of gravity of the car body, which is most desirable for performance in curves.

Relatively high super elevation is permissible for the system 10. In bottom-supported systems, super elevation usually is limited to  $6^\circ$  by comfort conditions in case a vehicle becomes stationary on a curve. These considerations of comfort in vehicles stationary on curves do not apply to overhead-suspended systems. In case of a suspended vehicle stopping on a curve the suspended car simply returns to the vertical position. The limit on super-elevation depends upon the friction between the vehicle and the track, such that the downward force of gravity should not cause the vehicle to slip sideways down towards the lower side. The coefficient of friction of steel wheels on steel rails is known to be greater than the selected super-elevation would require. Laboratory experiments using  $\frac{1}{8}$ -scale models were performed by tilting the track with steel-wheel trucks on steel rails to measure the angle of super-elevation when the wheels first slipped across the track. The results measured this angle to be not less than  $16.23^\circ$ . The diagrams and calculations in this submission are based conservatively upon the admissible super-elevation being  $10^\circ$ , approximately 10 inches on standard gauge of  $56\frac{1}{2}$  inches.

Operating up to  $10^\circ$  of super-elevation uses only 62% of this range. If at any time the angle of slip might be exceeded, the flanges slide towards the rail and the slip controlled by the flanges of the wheels. Although rail stability must be taken into account, in view of the margins in angles of slip found in this experiment, it is quite reasonable to continue using  $10^\circ$  for planning purposes. Apparently using  $10^\circ$  for super-elevation and for outward swing is quite conservative.



High swinging out of the car body will be permissible. Centrifugal force creates an outward force on the truck and track. The limit is to prevent the wheels from sliding sideways up towards the high side. The value presently adopted is the same: 10° of outward swing in addition to the super-elevation of the track, allowing a total 20° of outward swing, equivalent to a centrifugal force of 0.34 G. The accepted value of outward swing governs the limit of speed and comfort on a curve. General Formation

- The Site shall be formed to the levels agreed upon with IE.
- The Site shall be surfaced in a manner, compatible with their intended use, and, in particular, footpaths and roadways and connecting facilities shall be clearly defined. Measures shall be taken to ensure that all areas are properly drained and kept free of static water.
- The removal, diversion or reinstatement elsewhere as may be required of any existing works or installation whatsoever within the Site shall be carried out to the satisfaction of the IE.

### **Roads and Parking**

- Space shall be provided within the Site for parking, loading/unloading and manoeuvring of motor vehicles.
- Any damage done to the adjoining public roads and fixtures and properties (public or private) shall be made good by the Concessionaire to the satisfaction of the IE.

### **Drainage and Sewerage**

- All storm or rainwater from the Site including any access roads thereto shall be conveyed to the nearest stream course, catch-pit, channel or storm water drain as required. All temporary and permanent works shall be carried out in such a manner that no damage or nuisance are caused by storm water or rain water to the adjacent property.
- No drain or watercourse shall be used without approval.
- Damages or obstructions caused to any watercourse, drain, water- main or other installations within or adjoining the Site shall be made good to the satisfaction of the IE.
- Treatment and disposal of sewage and wastewater from the Works area shall be provided to the satisfaction of the IE.

### **Buildings**

- No permanent structures other than those required for the permanent works shall be permitted on the Site.
- Electricity, water, telephone and sewerage shall be provided by the Concessionaire, as required, for all temporary buildings.
- No potable water from the local authorities shall be used for heating, cooling and humidification purposes, or vehicle washing without the written consent of the authority concerned.



**Pedestrian Access**

Every existing pedestrian access throughout the Site shall be maintained in a usable condition at all times including lighting, signing and guarding.

**Fencing** The Site shall be secured against unauthorized access at all times. In particular fencing or the like shall be maintained, removed and re-erected in the new location wherever and whenever a Works area is relinquished in stages.

**Work on Site**

The Concessionaire shall nominate a representative whose name and qualifications shall be submitted in writing to the Independent Engineer for review not later than 4 weeks before his appointment and who shall be solely responsible for ensuring the safety of all temporary electrical equipment on Site. The Concessionaire shall not install or operate any temporary Site electrical systems until this representative is appointed and has commenced duties. The name and contact telephone number of the representative having been reviewed by the IE shall be displayed at the main distribution board for the temporary electrical supply so that he can be contacted in case of an emergency. Schematic diagrams and the details of the equipment for all temporary electrical installations shall be submitted by the Concessionaire, and these diagrams together with the temporary electrical equipment shall be submitted to the IE for his review.

All electrical installation work on Site shall be carried out in accordance with the requirements laid down in BS 7375. All works shall be supervised or executed by qualified and suitably categorized electricians, who are registered as such under the Electricity Ordinance 1990/Electricity (Registration) Regulations 1990.

**Rolling Stock Cost**

The estimated cost per coach at April'1 Price level exclusive of taxes and duties may be assumed as INR 8 Crores per Coach. With single car train sets, total 10 coaches are required in the year 2019 and the budget provision of INR 112 Crores is to be kept in the Estimate for Rolling Stock. Coach manufactures is in India to reduce the custom duty tax cost.

This rate has been considered excluding the taxes.

Performance of EMS system is based on attractive magnetic forces. While EDS system works with repulsive magnetic forces. In EDS system, the vehicle is levitated about 1 to 10 cm above the track using repulsive forces. In EMS system, the vehicle is levitated about 1 to 2 cm above the guideway using attractive forces as shown in the figure.

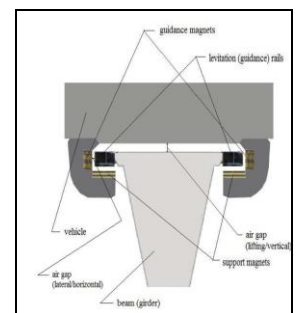
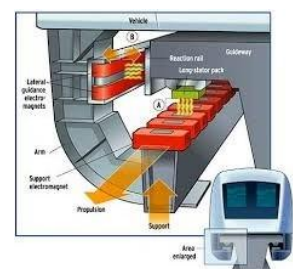





The electromagnet, initially when the train is started will in all probability not be perfectly lined up, so there will be a net force downwards. Also, if the train has some velocity, the train will have enough inertia to move to this point where it will feel the net force downwards, and will thus continue to move even faster downwards. Furthermore, the train will be in the magnetic field - which is the field due to the set of permanent magnets directly below the first set and the fields are pointing in the same direction, so there is an attractive force downwards (and by the same symmetry arguments used above, the train is also accelerated downwards by this set of forces as well).

When the train moves to the next set of magnets – the ones that it is attracted to – there will be an attractive force that resists motion. However, a sensor in the circuit senses the change in magnetic field, which sends a signal that causes the current to reverse. Thus the magnetic field of the electromagnet is in the opposite direction, the attractive force becomes a repulsive force, and the propulsion cycle continues.

To create levitation, a magnetic repulsion force is used to counteract the force of gravity. The right magnetic material must be used to achieve levitation. Magnetic materials are classified into three categories: paramagnetic, diamagnetic, and ferromagnetic. Among the three diamagnetic is the best option to go with since it repels the permanent magnet placed near it.

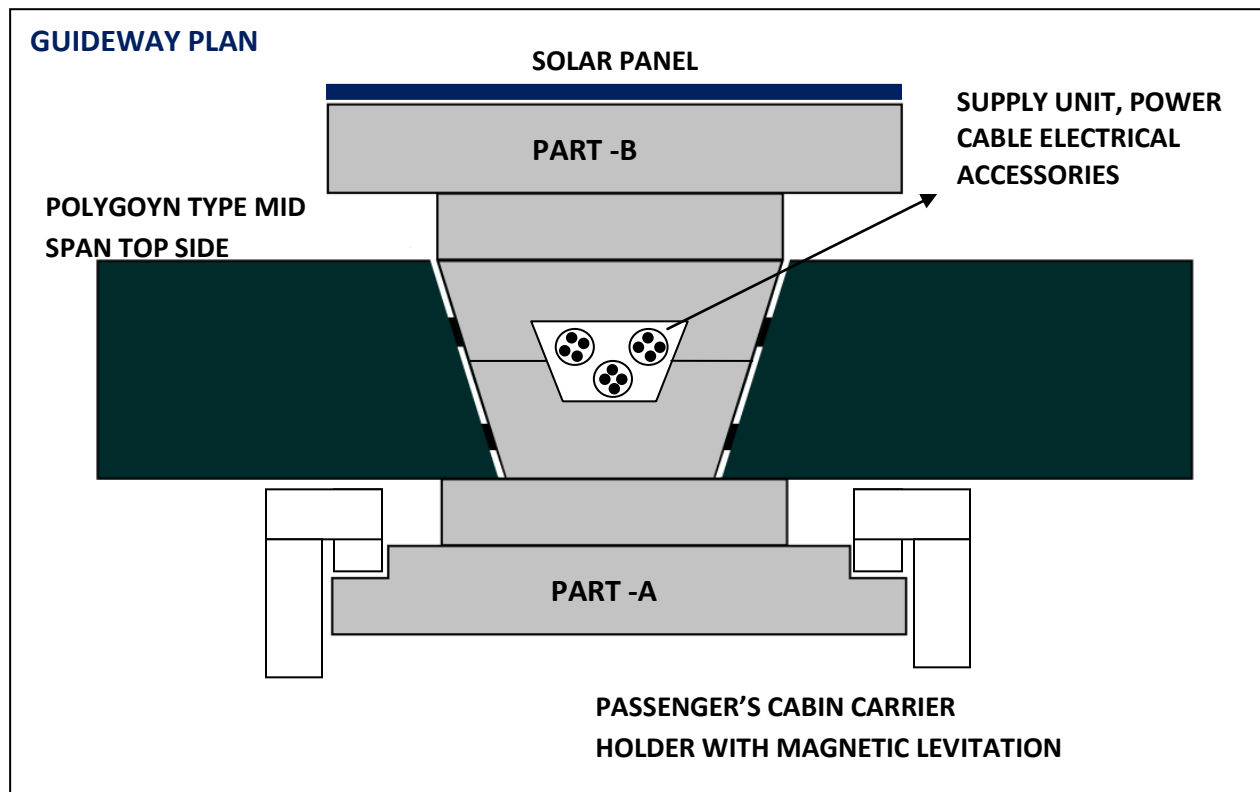



**Square Type Pier**  
**Pillar details (approximately)**

<b>Properties of Concrete</b>	
Compressive Strength of Concrete	60 N/mm <sup>2</sup>
Density of Reinforced Concrete	24 kN/m <sup>3</sup>
Elastic Modulus of Concrete	36000 N/mm <sup>2</sup>
Poisson's Ratio	0.15
Thermal Expansion Coefficient	1.17 x 10 <sup>-5</sup> /0C
<b>Properties of Reinforcing Steel</b>	
Yield Strength of Steel	500 N/mm <sup>2</sup>
Young's Modulus of Steel	205,000 N/mm <sup>2</sup>
Density of Steel	78.5 kN/m <sup>3</sup>
Poisson's Ratio	0.30
Thermal Expansion Coefficient	1.2 x 10 <sup>-5</sup> /0C

**Single Pier Structural System**  
**Reinforced Concrete Pier**

The behaviour factor of pillar structure's elastic response strength, the idealised yield strength, the first significant yield strength and the allowable stress design strength, therefore accounts for the inherent ductility, over the strength of a structure and difference in the level of stresses considered in its design. in force-based seismic design procedures. It is generally expressed in the following form taking into account the above three components, the ductility dependent component also known as the ductility reduction factor, is termed the allowable stress factor. Which the actual force-displacement response curve is idealized by a bilinear elastic-perfectly plastic response curve, the behaviour factor parameters may be defined as. The performance parameters of the section designed using force based design shows that the behaviour factor.

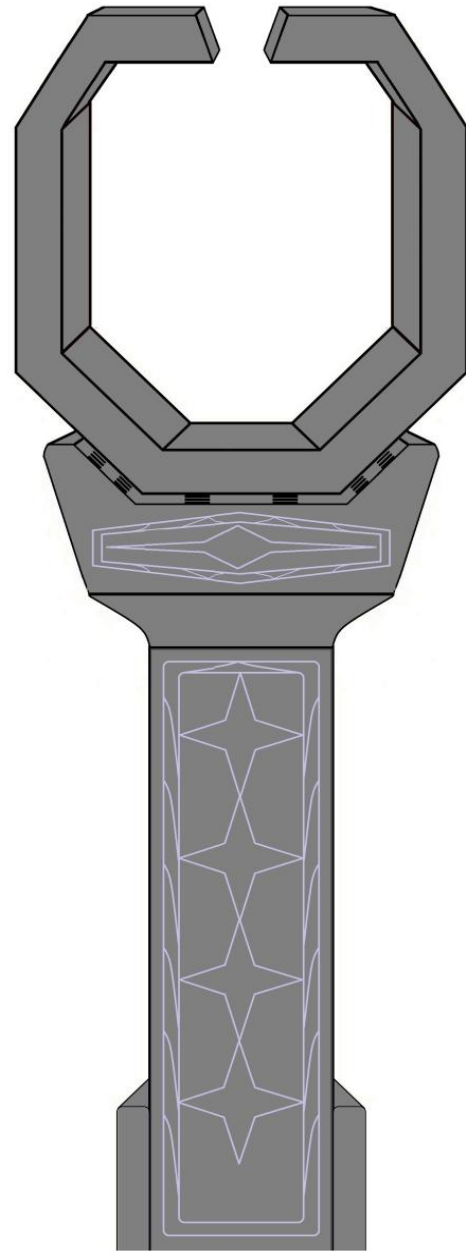

**Pillar with polygon type mid span**



## 14 - THE GUIDEWAY

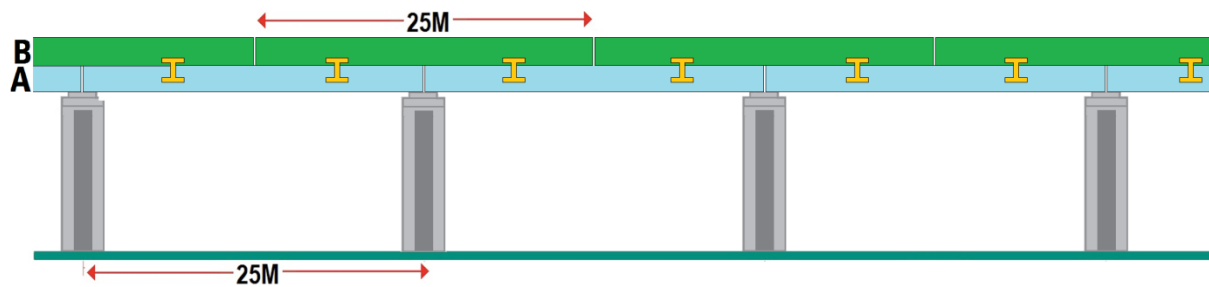

**Pillar with Guideway Alignments**

The guideway is the structure that MMDDRTS vehicles move over it and are supported and guided by it. Its main roles are: to direct the movement of the vehicle, to support the vehicle load, and to transfer the load to the ground. It is the function of the guideway structure to endure applied loads from the vehicle and transfer them to the foundations. It is the main element in MMDDRTS system and holds big share of costs for the system. It is vital for MMDDRTS trains. The cost of the guideway structure is expected to be 60-80 percent of the overall initial capital investment cost MMDDRTS train levitates over single or double track guideway. Guideway can be mounted either at-grade or elevated on columns and consists of individual steel or concrete beams. Elevated guideways occupy the least amount of land on the ground. Moreover, with such systems there is guarantee of meeting no obstacle while along the route. To guarantee safety for MMDDRTS trains necessitates guarantee that there will be no intersection between guideway and other forms of traffic routes. To serve the purpose, general proposition is to have elevated guideways.

Guideway provides guidance for the movement of the vehicle, to support the vehicle load, and to transfer the load to the ground. In MMDDRTS guideways contrary to traditional railroad tracks, there is no need to ballast, sleeper, rail pad and rail fastenings to stabilize the rail gauge. A guideway consists of a beam (girder) and two levitation (guidance) rails. Guideways can be constructed at grade (ground-level) or elevated including columns with concrete, steel or hybrid beams. MMDDRTS elevated guideways minimize land occupation and prevent collision with other forms of traffic at-grade intersections.

### **Guideway design**

Guideways are designed and constructed with concrete or steel girders. Concrete guideway girders can be as reinforced or prestressed. Guideway girder is evaluated for different load cases. The concrete metal guide tracks, for up and down tracks, are carried over square pillars of about 1 meter generally located along the median of the road. Every 25 meters each pillars and pier heads have a minimum clearance of 25 m above the road level.



Guideway is divided in two parts A&B, A part of the guideway is seated in 50% of the top middle centre of both pillar, and part B of the guideway length is seated in middle of the A pillar centre point .

### Guide way Construction

The System IS concrete metal guide which are made on they are manufactured using steel plates and a continuous welding machine and will be fabricated in a specially built factory in a suitable location at the start of the first line. After fabrication, they will be transported along the newly constructed System guide for erection. This will significantly reduce construction costs and disruption to traffic. At the site, they will be erected using bridge construction techniques. This process will be enhanced by the adoption the “CIM Steel” system (Computer Integrated Manufacturing) that has been recently developed and adopted in Europe. In this process, the geometry of the steel is developed and then structurally analyses in the engineering office. The final design data is then transmitted electronically directly to the fabrication shop for fast, computerized, “just in time” manufacture and immediate delivery to the site. This process will give significant time and cost benefits.

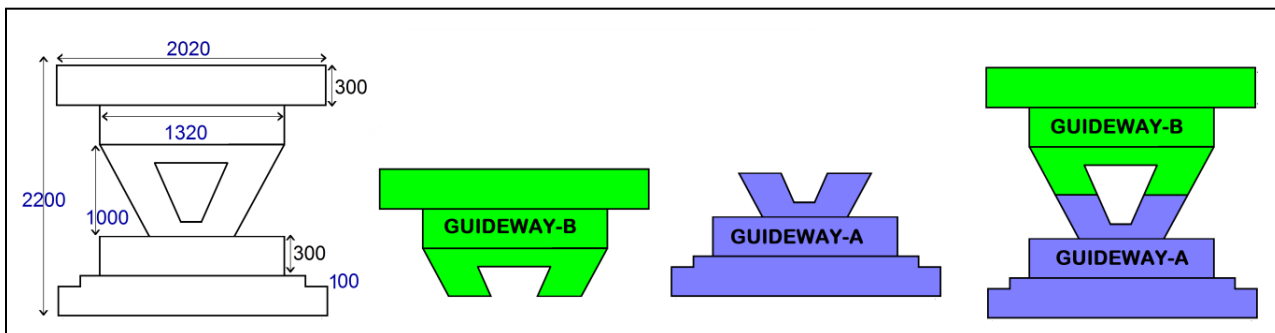

**Concrete Guideway sketch**

Tolerances for Finished Segments of pre-cast polygon type mid span is divided into two parts A (Blue Color) and B (Green Color)

The Tolerances shall not exceed the following:

Length of totally guideway 25 m

A part of the slab width is 2020mm

A part of the slab two steps, first is thickness is 200 mm

A part of the slab second steps first is thickness is 100 mm

A part of the projection size 200mm

B part of the Slab Thickness is 300 mm

B part of the slab width is 2020mm

B part of the projection size 1320mm



### **Elevated Guideway Structure – Design Criteria**

This outline design criteria provide minimum standards which are to govern the design of the permanent works and shall be read in conjunction with other contract documents.

#### **Guideway Structure: General Design Guidelines**

- The carrying magnetic concrete guideway structure should be designed for Load configuration based on Coach Design and Train configuration. Other loads and forces to be considered for design should be in accordance with the technical characteristics of the Rolling Stock.
- The Indian Railway's Concrete Bridge Code shall be followed for design for RCC sub-structure and foundations and for pre stressed concrete girders with internal pre stressing. For superstructure with external pre stressing, International Standards shall be followed.
- The reinforced concrete guideway beams structure shall be supported and on single columns erected mostly along median of the road. At few locations it may be necessary to adopt portal frame support in lieu of single column.
- Detailed topographic and geo-technical investigations along the corridor shall be carried out by the Concessionaire.
- The minimum clearance above the road level shall be 5.5 m. In case of minor roads/streets lower clearance may be adopted with specific approval of the agency or authority owning and / or maintaining the road/street.
- Ducts for laying electrical signal and communication cables shall be provided on either side.
- Adequate drainage shall be provided for the guideway structure and connected suitably to the underground drainage.
- The pre-fabricated, conventional, reinforced concrete box beams, with their attached aluminum-loop panels, is mass produced at low cost at a factory. The beams are then shipped from the factory, by truck or rail, to the Maglev construction site, along with the prefabricated piers. The only field construction required is the small poured concrete footings for the piers. Cranes lift the beams and piers into place, allowing a complete guideway route to be erected in a few weeks. The beams and piers can also be transported along finished portions of the guideway to the erection site, eliminating the need for road or rail transport. For construction of the guideway structure, use of prefabricated elements to the maximum possible extent shall be adopted in view of the need for fast track work and the corridor being heavily congested.
- The structure should be aesthetically pleasant.
- Approach slabs shall be provided between viaduct and at grade section.





## 15 - POLYGON TYPE MID SPAN CONSTRUCTION

Of the lateral polygon perimeter is absolutely necessary in order to exclude air pressure noise as well as are Visual stimuli. These project constraints led to use precast segmented span erection method. This construction method is the optimal one in terms of construction speed, quantity optimization, and construction quality and risk management.

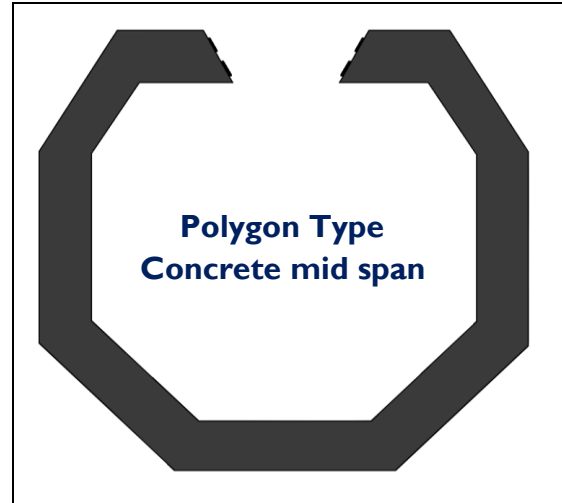

IAT-MAGLEV construction, (alternatively with solar systems to implement) the concrete metal polygon type mid span which are made on factory site and they are pretend will be fabricated in a specially built factory in a suitable location at the start of the first line. After fabrication, they will be transported along the newly constructed System guide for erection. This will significantly reduce construction costs and disruption to traffic. Chosen polygon mid span bridge construction technique had to meet several requirements due to speed of construction, geometry adjustability, environment disturbance. Depending on speed requirements, the sound emission will be varied in the distance of the polygon perimeter in the construction field in width to reduce the sound pressure. Within built-up areas at low speed and the local space limiting the lateral distance to the cabin has hardly any significant effect on noise. Outside of cities at high speeds a widening

### **Transportation and Erection of Segments**

The movement of segments on road shall be done at night or early morning, so that the disturbance to traffic at the ground level is minimized. Sufficient number of Mobile cranes of adequate capacity and boom length shall be mobilized by the Concessionaire at the casting yards. The transportation and movement of the segments at ground level shall be effected by low-bedded trailers. Segments shall be lifted and assembled by the Launching Girders (LG). Adequate number of LGs for erection shall be mobilized to satisfy the requirement of target milestones. Segments shall not be moved from the casting yard until all curing and strength requirements have been attained, and shall be supported in a manner that will minimize warping. A full scale load test of the Launching Girders, lifting and temporary holding hardware shall be performed to demonstrate the adequacy of this equipment prior to beginning any erection of the segments.

The Concessionaire may propose any alternative erection scheme and submit the same for review by the Independent Engineer.



### **Concrete**

The 28 day characteristic strength of structural concrete measured on 150 mm cubes shall meet the minimum specified strength as mentioned below.

Construction work with design mix concrete through computerized automatic batching plants shall be adopted with following minimum grades of concrete for various members as per design requirement / durability considerations.

- (i) Piles, Pile cap and open foundation – M 35
- (ii) Piers – M 40
- (iii) All pre-cast element for viaduct and station – M 45
- (iv) Cantilever piers and portals – M 45
- (v) Other miscellaneous structures – M 30

For all the main structures, permeability test on concrete sample is to be undertaken to ensure impermeable concrete.

### **Safety Precautions**

Since heavy loads have to be handled over moving traffic, safety is of utmost importance. The Concessionaire shall enforce a strict Safety System with all necessary precautions and instructions (safety tools, nets, railings, personal protection equipment, proper training of workers, first aid, etc.). No unskilled/ untrained personnel shall be engaged at site to perform the critical activities above the flowing traffic at ground level. The Concessionaire shall be solely responsible for ensuring safety at site during the construction period.

### **Drawings and Design Calculations**

- (a) General

The Concessionaire shall submit, “Method Statements”, according to an agreed schedule, covering complete details and information concerning the method, materials, equipment and procedures he proposes to use at site.

- (b) Design calculations for construction procedures

In addition to the design calculation for permanent structures, design calculations shall be submitted for false work, erection devices, formwork or other temporary construction which may be required and which will be subject to calculated stress for review by the IE.



Computations for the following shall be submitted for review by the IE:

- (i) Construction Stage Stress Check in superstructure during all stages of erection using Launching Girders as per the Concessionaire's proposed erection scheme (Design Construction Integration);
- (ii) Calculations for pre-camber correction required in pre-casting moulds/beds taking care of all post-tensioning forces, temperature, creep, shrinkage etc., computations of deflections and required camber due to dead loads, post-tensioning forces, creep and shrinkage. A tabulation of deflections and camber dimensions shall be included on the shop drawings; and
- (iii) Computation of jacking forces required at pre-cast glued joints during temporary post-tensioning and resultant compressive stress at interface of segments.

### **Codes and Standards**

The following codes shall be applicable:

IRS; IRC; IS; AASHTO; and BS.

Indian Railway Standards (IRS).

IRS – Bridge Rules for loading (Min. of Railways).

IRS – Code of practice for steel bridges.

IRS – Code of practice for plain, reinforced and pre-stressed concrete for general Bridge construction, latest revision.

IRS – Code of practice for the design of substructures and foundation of bridges.

IRC-18 – Design Criteria for Pre-stressed Concrete Road Bridges (Post Tensioned Concrete).

IRC-21 – Standard Specification and Code of Practice for Road Bridges, Section III – Cement Concrete (Plain and Reinforced).

IRC-22 – Composite Construction for Road Bridges .

IRC-78 – Foundation and Substructure.

IRC-83 (Part-I) – Metallic Bearings.

IRC-83 (Part-II) – Elastomeric Bearings.

IRC-83 (Part-III) – POT cum PTFE Bearings.

IRC-SP –47 Guidelines on Quality Systems for Road Bridges (Plain, Reinforced, Pre-stressed and Composite concrete).

### **Reference codes and standards**

The following codes and standards shall be adopted:

- National Building Code.
- Bureau of Indian Standards (BIS).
- National Fire Protection Association.



- ASTM Standards in Building Codes.
  - International Standards Organization (ISO).
  - American Society of Civil Engineers (ASCE).
- American National Standards Institute (ANSI).

### **Loading**

The most important part in the analysis and design of guideway is structural loading. The loading of the MMDDRTS vehicle is an important parameter in the practical application. It is related to the magnetic forces. The guideway must carry a dead load due to its own weight, and live loads including the vehicle loads. To incorporate the dynamic interaction between the guideway and the vehicle, the live load is multiplied by a dynamic amplification factor. Lateral and longitudinal loads including wind and earthquake loads may also need to be considered. The guideway loadings are modelled as dynamic and uniformly distributed magnetic forces to account for the dynamic coupling between the vehicle and the guideway. Magnetic forces are generated by the MMDDRTS vehicle and cause structural loading that transmits to the guideway. This can happen whilst such a vehicle is stationary or in motion. In order to prevent contact between the vehicle and the guideway and maintain the required gap between them, the system is continuously under Operation Control System (OCS) command.

Some decisive factors for the design of MMDDRTS guideways are listed as being constructible, durable, adaptable, reliable, readily maintained, being slim in accordance with urban environment and being light to be constructed more efficiently (Jin et al., 2007). In this regard, one of the main challenges to guideway designers is to produce a structure that will be easily maintainable to the narrow tolerances and precise alignment required for practical MMDDRTS operation, to achieve a structure which is economically and financially justifiable and attractive. Besides satisfying the above conditions, important parameters in the design of guideway include vertical live loads and its pursuant dynamic amplification factors (DAF), plus deflection due to this load. These parameters constantly govern the design process, and they play a major determining role in the structural optimization of the guideway girder systems. Vehicle/guideway interaction of the MMDDRTS system is an important and complicated problem. It is influenced by the levitation system, guideway structure, vehicle mechanical structure, running speed, etc. So the investigation of it should be launched out in many aspects. Among the various parameters which affect on design of MMDDRTS guideway, dead and live loads, dynamic amplification factor and deflection have major importance. Assessment of deflections due to the vertical loads for guideway beam during operation of MMDDRTS vehicle is very important. It is the most influential parameter in design of guideway.



While there are routine processes for the calculation of the guideway dead loading, there is a need for special treatment in the calculation of its live loads. Live load intensity and its distribution patterns are highly dependent on the structural behaviour. According to AREMA (American Railway Engineering and Maintenance-of-Way Association) and UIC (International Union of Railways) regulations live load models for conventional railway track are based on a combination of concentrated and distributed loads. This is compatible with the use of wheels and the behavior of locomotives in conventional trains. In the case of trains with magnetic levitation with no wheels and added complexity of lifting magnetic forces due to support magnets, the analysis is much more complicated.

### ***Lifting magnetic forces (vertical loads)***

Vertical loads imposed on MMDDRTS guideway can be categorized as dead loads due to the weight of the guideway divided by the length of the span, and live loads due to the interaction between guideway and the vehicle. Dynamic magnetic lifting forces are the forces generated while the vehicle moves. The interaction force (total dynamic lifting magnetic force of each car body) between each car body and the guideway, is the sum of the interaction forces (dynamic lifting magnetic forces) between the nth bogie in each car body and the guideway. Also, considering the fact that each guideway consists of two levitation rails, the interaction force between the nth bogie in each car body and each of the levitation rails, is equal to one-half of the interaction force between the nth bogie in each car body and the guideway. Interaction force between each bogie in each car body and the guideway is a uniformly distributed live load. Load uniformity comes from the absence of the wheels and presence of lifting magnetic forces with uniform intensity that is generated by support magnets. Interaction force between each bogie in each car body and each of the levitation rails is also uniformly distributed.

If bogie lengths in each car body are the same, as normally is the case, then the total interaction force intensity between each car body and the guideway is equal to the interaction force intensity between the nth bogie in each car body and the guideway over the length of bogie. Also, in such case, the total interaction force intensity between each car body and each of the levitation rails over the length of each car body is equal to the interaction force intensity between the bogie in each car body and each of the levitation rails over the length of each bogie. Each MMDDRTS vehicle involves some (one to n...) no of car bodies with different lengths. Hence, maximum interaction force intensity between car bodies and the guideway can be considered as MMDDRTS live load. In general, MMDDRTS live loading is evenly and uniformly distributed. The amount of MMDDRTS live load is generally less than the dead load of its guideway. Also, the uniformly distributed live load of MMDDRTS applied to each levitation rail over the length of live loading.





### **Lateral magnetic forces (lateral loads)**

In the static case, lateral (guidance) magnetic forces do not exist. However, during vehicle movements and while it moves to the sides, interaction of guidance magnets and levitation rails brings the vehicle back to its central stable position. This causes lateral magnetic forces.

These lateral forces act in lateral and normal directions to the levitation rails and transmit to the guideway. When the vehicle deviates to the right, guidance magnets on the right side of horseshoe shaped section of the vehicle and levitation rail on the right side of guideway attract each other while guidance magnets on the left side of horseshoe shaped section of the vehicle and levitation rail on the left side of guideway repulse each other. This brings the vehicle back to its stable position. At the location of interaction between guidance magnets and levitation rails, forces in the left and right zones are of the same size and act on the same direction to the guideway.

One of the main advantages of the elevated transportation systems such as MMDDRTS is the high resistance of their tracks in dealing with the earthquake forces. Irregular earth movements generate such forces that can be capable of damaging the manmade structures. The size of such forces depends on the nature of the earthquake, the natural period for the bridge structural vibrations and the natural period for vibrations of the soil under the foundation. For the design of the exceptional bridges with very large spans or for the bridges that are near the earth's fault lines, calculations for the earthquake forces depend on some detailed studies. One may use the static analysis for the design of small to medium size bridges. Dynamic bridge analysis however, needs huge number of calculations that are economically formidable and sometimes turn to be impossible. On the other hand, the quasi static approach uses a load (or an impact) factor that converts the dynamic loads into the static loads. Therefore, such method assumes static equilibrium when determining the structural behaviour. The load (or the impact factor) comes from the experiences, engineering judgment and from mathematical models. Generally, the wind effect depends on the geographical position of the district, its altitude from the sea level, the local topography and to some geometrical characteristics. For the guideway static calculations, regardless from the number of the tracks the wind force affects only one MMDDRTS vehicle.

The interaction force (dynamic lateral magnetic force) between the  $n$ th bogie in each car body and each of the levitation rails is defined by the summation of the interaction forces (dynamic lifting magnetic force) between the bogie in each car body and each of the levitation rails and the wind or the earthquake lateral force, whichever that turns to be bigger.

Lateral forces on the MMDDRTS guideway can be caused by the vehicle sliding, particularly on curves. Lateral guidance is provided by guidance magnets. The dynamic lateral magnetic force imposed on the guideway can be considered as a uniformly distributed load. Centrifugal forces, in equal speed and curve radius, are less in MMDDRTS due to lower weight of the vehicle than in rail tracks.



### **Longitudinal loads**

In recent years, with increasing travelling speed of the rail systems, aerodynamic load problems became very important. From the system point of view, aero dynamical topics which affect and define the interface between rolling stock, infrastructure and operation are of paramount importance and the corresponding loads increase with the vehicle speed. If MMDDRTS vehicles pass in close proximity to each other or move close to fixed objects such as barriers or buildings, the aerodynamic interactions can produce significant loads on the vehicle or the fixed object. The magnitude and duration of the load depends on the velocity and geometry of the vehicles and also on the ambient wind speed and direction. For high speed railroads several studies have examined the loads produced by passing trains and their potential for causing an accident. The results of these studies show an important pressure load acting on the object which can have serious consequences.

- Although the safety aspect does not concern the maglev vehicle as strongly as it concerns conventional railroads, because MMDDRTS is guided by magnets on both sides and cannot derail, many aspects are similar. In both cases, the interaction of vehicles and infrastructure implies aerodynamic system issues e.g. that of train induced aerodynamic loads leading to structural vibrations and a decrease of ride comfort. The pressure load caused by passing MMDDRTS vehicles has an important aerodynamic effect on the sidewall motion and therefore on the ride comfort. While two vehicles are passing each other at high relative speed, the quasi-static pressure distribution along each vehicle presents a dynamic load on the other vehicle. The dynamic pressure load strongly depends on the velocity of the vehicle, the geometry of the bow-part of the vehicle and the distance between the guideway. The time behaviour is given by the relative velocity between the two vehicles. The mechanical load on the car body depends mainly on
  - the amplitude of the pressure wave,
  - the velocity of the oncoming vehicle,
  - the bow-shape of the oncoming vehicle, and
  - The distance between the two tracks.
- The relation between the propagation speed of the structural Eigen mode with the corresponding wavelength and the relative velocity between the two vehicles
- the load at a specific point of the structure depends on its location within the car body, but not on the overall length of the vehicles or the position of the carriage body within the vehicle set.

In general, the aerodynamic forces play an important role in affecting the interaction response of MMDDRTS-vehicle/guideway system due to their velocity-dependent characteristics, especially at higher speeds found in HSR systems around the world. Longitudinal force can be applied to the guideway through braking and acceleration of the vehicle, vehicle weight when the guideway has a longitudinal slope, and air pressure (aerodynamics).



Since MMDDRTS vehicles have no wheels, axles and transmission, they weigh less than a conventional railroad train. The lack of wheels also means that there is no friction between the vehicle and the guideway. These factors result in a reduction in energy consumption. Therefore, the vehicle requires a lesser force for braking and stopping it.

### **Analysis**

During the past four decades, research and development have been performed in the areas of magnetic levitation, interaction of vehicle with guideway, and optimization of vehicle suspensions. The results of these efforts are useful in providing appropriate criteria for the design of MMDDRTS systems. The dynamic response of magnetically levitated vehicles is important because of safety, ride quality and system cost.

### **Escalators**

Platforms will be elevated, allowing direct access through train doors without steps or ramps. No free passenger access to the guideway will be permitted, for safety reasons. This is mandatory due to the speed and low noise profile of MMDDRTS systems. The use of docks and in-station transfer switches means that passing trains, while not necessarily in close proximity to platforms, could injure anyone who strayed into the active main guideway. For vertical circulation all MMDDRTS system stations will provide escalators and elevators as the primary elements and stairs as the backup.

The station services, including public rest rooms, snack service, newsstand, staffed ticketing and information center, and public telephones should be provided. Stations should also provide facilities (shops, changing rooms, luggage storage, etc.), access to traveller services such as station cars, and advertising displays. All stations would feature public art appropriate to their locations. Public art is an excellent adjunct to station design and a popular feature. Train and station operations require the station personnel and security. Station managers and ticket agents control the station activities, providing passenger assistance and information as well as inspecting train sets when in station. Armed security personnel are provided at every station. Large stations have multiple security personnel, and parking garages are policed.

### **Operation Performance**

The most important task or essential aim when designing the alignment is to specify the geometry of the guideway's functional planes so that the passenger travelling in the vehicle on the guideway experiences optimum comfort during the journey. The geometry defines the limit values for accelerations in the three spatial directions (X, Y, and Z direction).



However, apart from the acceleration, the consideration of the change in acceleration (jerk) is also an important aspect for comfort. Therefore, various mathematical formulae were discussed for the transition curves and lengths, with the result,

- the horizontal transition curves are designed as sinusoidal curves and the vertical transition curves are designed as clothoids.

An exception are the track switching devices which, based on beam theory, are also designed using clothoids for the horizontal transition curves in the turn-out position. The alignment is designed and the space curve established taking into consideration the aspects given above as well as the system characteristics, e.g.

- climbing capability up to 10% and
- Can't (super elevation) in curves up to 12%.

The space curve data are used in the next design phase as the design criteria for

- specifying the substructures,
- height of the columns,
- geometry of each individual beam,
- location of the track switching devices and for the
- Precise location of the functional components on the beam.

The reductions in speed in the track course result from slopes, where the residual acceleration abilities do not maintain a high speed. The primary energy demand that is relevant for the comparison between different means of transport averages under the examination of the current power mix as 2.5 times the secondary needs.

### **Optimal design speed**

The optimal design speed of transportation project relates not only to the national integrated transportation system structure, but also to the energy consumption structure of national economy and the travelling quality of passengers. Starting from the analysis to technical and economical characteristics of the MMDDRTS system, this paper tries to find the optimal design speed of MMDDRTS transportation system in different aspects such as the speed structure of integrated transportation system and the project benefit. As a result, it gives reference to the planning of MMDDRTS transportation project. The determination of the design speed is a strategic decision-making for a transportation model. It relates to the compatibility with social economic development. The design speed of a transportation model has remarkable influence on its construction and operation cost, the ability of its competition in transportation system.

The maximum operating speed the train may be raised step by step along with the market demand and the technical development. Therefore, the optimal design speed of mobile equipment of a project should be considered according to the conditions in the near and far future.



### **Substations: Traction and Power Supply**

Electronic control systems control the clearance (nominally 10 mm). The levitation system uses on-board batteries that are independent of the propulsion system. The vehicle is capable of hovering up to one hour without external energy. While travelling, the on-board batteries are recharged by linear generators integrated into the support magnets. A synchronous, long stator linear motor is used in the Trans rapid maglev system both for propulsion and braking. It functions like a rotating electric motor whose stator is cut open and stretched along under the guideway. Inside the motor windings, alternating current is generating a magnetic travelling field that moves the vehicle without contact. The support magnets in the vehicle function as the excitation portion (rotor). The speed can be continuously regulated by varying the frequency of the alternating current. If the direction of the travelling field is reversed, the motor becomes a generator which brakes the vehicle without any contact. In accordance with Lenz's Law, the interaction of the levitation field with the current in the slots of the rail results in propulsion or braking force. During the motion of the magnet along the rail, the linear generator winding of the main pole is coupled with a non-constant flux, which induces a voltage and reloads the on-board batteries. The generation process begins in the range of 15 km/h and equals the losses of the magnetic suspension systems at 90 km/h. The whole energy losses of the vehicle are compensated at a velocity of 110 km/h and the batteries are reloaded. Thus the levitation magnet integrates three tasks: levitation, propulsion and transfer of energy to the vehicle

#### **The main requirements for a transportation system are:**

- Length of guideway,
- passenger capacity,
- travel time to destination,
- Maximum waiting time for passengers at the stations.

#### **Therefore the main design parameters for a transportation system are:**

- alignment,
- comfort criteria,
- speed profiles,
- operation concept including headway times,
- Availability, reliability.





## 16 - RENEWABLE ENERGY – OUR POWER SOURCE

Non-conventional energy is sources that are continuously replenished by natural processes. For example, solar energy, wind energy, bio-energy, bio-fuels grown sustain ably), hydropower etc., are some of the examples of renewable energy sources. A renewable energy system converts the energy found in sunlight, wind, falling-water, sea waves, geothermal heat, or biomass into a form, we can use such as heat or electricity. Most of the renewable energy comes either directly or indirectly from sun and wind and can never be exhausted, and therefore they are called renewable.

However, most of the world's energy sources are derived from conventional sources-fossil fuels such as coal, oil, and natural gases. These fuels are often termed **non-renewable** energy sources. Although, the available quantity of these fuels are extremely large, they are nevertheless finite and so will in principle 'run out' at some time in the future Renewable energy sources are essentially *flows* of energy, whereas the fossil and nuclear fuels are, in essence, *stocks* of energy.

### **Solar power**

The growth of a country can be gagged directly from its growing demand for energy. If the demand for energy is not met in- time then it would severely hamper growth leading to economic meltdown and collapse. India is a developing economy with a vast potential for industrialization. However, the ever increasing energy deficit faced by the country has led to a severe economic slowdown. Apart from the industrial demand for electricity, transport sector is also a major consumer of energy in the country. This research, keeping in view the importance of transport sector as well as its energy requirements, proposes to utilize solar energy for the development of a solar powered railway transport system in the country. For this purpose, the solar energy potential of India has been evaluated and a case study for solar powered vehicles is presented, with an aim of utilizing renewable energy resources within the country.

### **Generate green power**

Generate electricity with energy from the sun, wind or water, producing virtually no pollution or emissions.

### **Gain power independence**

With the use of batteries and possibly a generator as needed, you can rely on your own generating capacity, and not on the vagaries of public utilities.

### **Ensure uninterrupted power**

With a battery backup system, you can keep your appliances running during utility power outages.

### **No moving parts**

Solar electricity is the *only* form of energy generation that does not involve any moving part, substantially decreasing maintenance requirements and increasing reliability and long equipment life.



## **Land Acquisition**

### **Land for depot**

100 Acres 20 Megawatt Power Plant Land will be acquired from the Tamil Nadu Government near Mahabalipuram at Poonjeri Village, hardly 500 meters for both setting up the Power plant as well as the vehicle depot two acres for the depot land, eighteen acres for setting up the main solar power plant. Apart from this, some suitable land areas will also be acquired from the Tamil Nadu government or bought from private property lenders for setting up the station premises Or any other utilities.

### **Solar Powered**

Solar powered railway transport more efficient the carriages must be designed light weight, while at the same time they must be stable at efficient speeds. In this context, the authors are working on stable track designs that would be able to support light weight high speed railway system. For this purpose, a case study is being undertaken on the prospects of launching such a system in a tropical metropolis the average solar insolation of about 525 W/m<sup>2</sup>. Taking a practical example of a light weight train, typically a light rail carriage with a design load of carrying 160 passengers is powered by one DC motor per power truck with typical dimensions. The aforementioned statistics warrant a serious research toward the designing, analysis and prototyping of a PV based light railway system. In this context, the authors are in the process of launching the design and analysis phase of this project. This phase will involve detailed mechanical designing based on scaled down modeling, analysis and testing and evaluation. Once this phase has been completed, a full scale prototype will be developed and tested. Once this phase is successfully completed, the project can be launched on a commercial scale. A typical solar power railway station would be designed to receive maximum solar insolation. This depends on two major factors, firstly, orientation of the sun and secondly, the surroundings through which the train would pass, the movement of the sun from rising till setting is trending east-south in morning and west-north in the evening. The surrounding of the likely train route would have buildings of varying shapes and heights. This necessitate that solar railway building should be designed and oriented with slanting roofs and height of solar railway line is adjusted such that it receives maximum possible insolation throughout the day along the entire route. A suggested layout of the solar railway station MTC TRANS features of a typical solar panel fully covered in station are: A longitudinal building which has maximum exposure to sun.

- Ground floor can be used for elevators and commercial activities.
- Roof will be used for solar panelling.
- Side walls of first floor will also be used be for solar panelling.
- Sides and roof of the train will be used for solar panelling.

The age of low cost fossil fuels is over and that warrants serious research into the development of alternate fuels.



- The transport sector consumes about 61.7% (approximately) of the world oil consumption while its contribution towards greenhouse emissions stands at 13.4 %
- From the economic as well as environmental point of view, research towards the development of alternate energy options for the transport sector is deemed necessary.
- Railway transport can be considered the most energy efficient and environment friendly mode of transport.
- Since the sun is the largest source of energy on earth, this research presents a case to carry out research towards the development and commercialization a light weight solar railway system.

Chennai has a tropical climate, specifically a tropical wet and dry climate. The city lies on the thermal equator and is also on the coast, which prevents extreme variation in seasonal temperature. The hottest part of the year is late May to early June, with maximum temperatures around 38–42 °C (100–108 °F). The coolest part of the year is January, with minimum temperatures around 18–20 °C (64–68 °F). Early March would be warm at 25 – 32 °C (75 – 90 °F), but still manageable. The average annual rainfall in Chennai is about 140 cm (55 in), and gets most of it during October-- December from the north-east monsoon winds. The state of Tamil Nadu, especially its awe-inspiring temples, is the repository of the best of Dravidian Culture, and Chennai show cases all of it in splendid manner to the visitors.

UNITY INFRA Power Plant Farm is a 20 Megawatt electricity generation plant designed to produce electricity by solar energy in Chengelpet zone of Tamil Nadu solar photovoltaic (PV) technology that converts solar energy directly into electricity, while emitting zero greenhouse gases (GHG) into the atmosphere. The project is planned to be implemented in phases of 20 MW each and would become operational and start generating of the first phase of the **MTC TRANS SYSTEM** purpose only, with work on the other phases continuing. The generated electricity will be supplied to the national grid or direct to use of transit project.

**Unity Infra** 20 mw capacity grid-connected solar photovoltaic power plant near Chengalpattu village in Kanchipuram district near Chennai which is the first of its scale in India. The **Unity Infra** power plant is located at Chengalpattu a latitude of 12° 42' 0" and a longitude of 79° 59' 0" The overall area occupied by photovoltaic modules is 100 acres. The 20 megawatt power plant planed has is use of transit project is divided into 20 independent segments of each MW. Each segment is equipped with four Inverters of 250 kW each and grouped together to form one LT panel. Depending on the mix of 225 & 240 Wp modules, 45 to 46 PV Arrays are connected in parallel to each single Inverter, and each array consists of 24 modules connected in series.



The power generated from 3 MWp PV Plant at 0.415 kV is stepped up to 11 kV with the help of three step-up transformers and connected to existing 11 kV lines.

3 MW Segments

Initially segment of electrical energy generated by the plant during period 2017 to 2018 was 3.34 million kWh and 3.30 million units were sold to the grid or utilise construction works and all infrastructures works.

Although the performance of the photovoltaic modules was good, there was teething troubles associated with the inverters, which was the main reason for reduced energy generation. The impact of temperature variation of modules on their performance was studied both on daily and yearly basis. It is observed that the efficiency of the plant is more sensitive to temperature than the solar insulation. Daily datasets of five minute average data have been used for in-depth analysis. Some of the maintenance and technical related problems faced by the plant operators have also been discussed.

ESTIMATEION OF 3MEGWATT POWER PLANT

Table with 2 columns: Item and Cost (In Rupees). Rows include SPV Arrays, Pcus, Mounting Structures, Cables & Hardware, Junction Box & Distribution Boxes, Lightning Arrester, Earthing Kit, PVC Pipes & Accessories, Spares For 3 Years, SCADA System, Taxes, CST/KVAT, Etc., Design, Engineering, Quality Surveillance, Testing, Transportation, Insurance Coverage, Etc., Total Supply Of Equipments (For 3 MW), Erection & Commissioning, 3megwatt power total, and 58,73,77,400\*6.5=20 Megawatt Power Cost.



### Three Segment of 3 Megawatt Power Plant Diagram

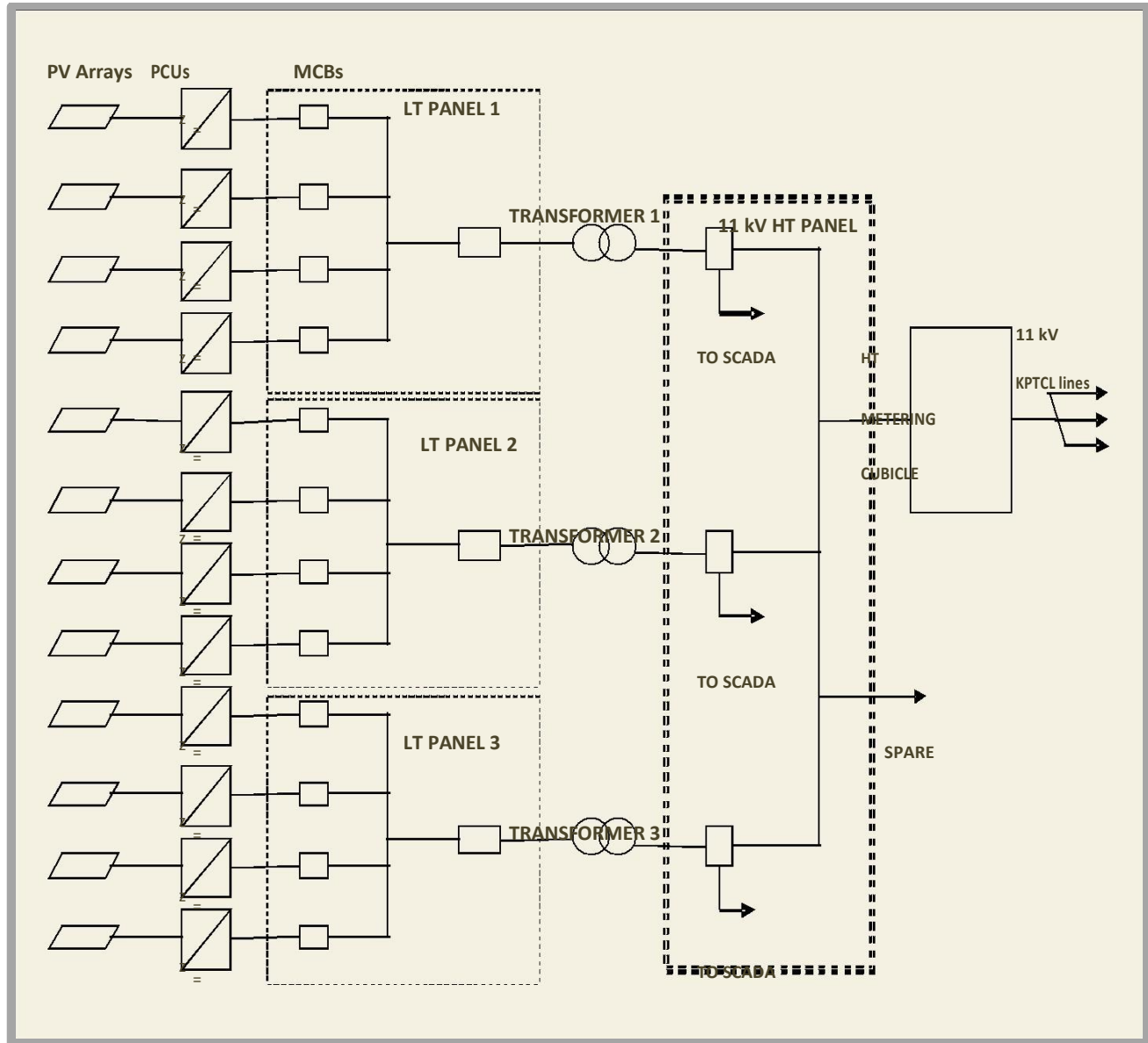

Monthly mean maximum & minimum temperature and total rainfall based upon 1901-2000 data:

Station Name	Month	Period	No. of Years	Mean Temperature °C		Mean Rainfall in mm
				Maximum	Minimum	
Chennai (Minambakkam)	January	1901-2000	100	28.8	20.4	35.3
Chennai (Minambakkam)	February	1901-2000	100	30.5	21.1	13.0
Chennai (Minambakkam)	March	1901-2000	100	32.6	23.0	14.5
Chennai (Minambakkam)	April	1901-2000	100	34.7	25.8	15.9
Chennai (Minambakkam)	May	1901-2000	100	37.4	27.6	42.4
Chennai (Minambakkam)	June	1901-2000	100	37.3	27.4	53.9
Chennai (Minambakkam)	July	1901-2000	100	35.3	26.1	99.6
Chennai (Minambakkam)	August	1901-2000	100	34.5	25.5	129.9
Chennai (Minambakkam)	September	1901-2000	100	33.9	25.2	123.5
Chennai (Minambakkam)	October	1901-2000	100	31.8	24.2	284.6
Chennai (Minambakkam)	November	1901-2000	100	29.4	22.6	353.0
Chennai (Minambakkam)	December	1901-2000	100	28.4	21.2	146.3





**General Description Of Pv Plant**

Place of Installation	CHENGELPET TAMILNADU
Height above sea level	Elevation is 118 feet -36 meters
Ambient Air Temperature	Maximum: 40°C
	Minimum: 18°C
Relative Humidity	Maximum: 99.1% (during monsoon)
	Minimum: 18.3%
Rainfall	Annual average: 1160 mm Period: 4 months
	India
Latitude & Longitude of the place	12° 42' 0" 79° 59' 0"
Allotted Land Area	100 acres (10.3 acres effectively used)
Nominal Capacity of the PV Plant	20 MW
Owner	MTC TRANS CORPERATION
Installed by (Contractor)	Titan Energy Systems Ltd., Secunderabad
Modules	Titan S6-60 series
SCADA for diagnosing and monitoring	Yes
PCU (Inverters)	250 kW
HT Transformer and switchgear for	1.25 MVA for each MW

**Power Supply Traction Sub Station  
Electric Power System**

**General**

The fundamental difference between the dc-powered and ac-powered systems is that, in dc systems, each substation includes transformers and rectifiers which condition the power to relatively low voltage suitable for direct use by the vehicle propulsion equipment. In ac-powered systems the power is supplied by the substations directly, without rectification, at relatively high voltage necessitating further transformation on-board of the rolling stock for the voltage to be suitable for use by the vehicle propulsion equipment.

Each system type, whether dc or ac, is comprised of the following:

- Traction Power Supply System - includes traction power substations located along the route at predetermined locations. Traction Power Distribution System - consists of the overhead contact system (OCS) or third rail system. Additionally, switching stations are required for



ac direct-fed systems and along track feeder system, autotransformer stations and switching stations are required for auto transformerfed system.

- Traction Power Return System - comprised of the running rails, impedance bonds, and cross-bonds. In addition, ac electrification systems also use the ground (earth) itself as a part of the return system and are also equipped with static wires and grounding connections.

The traction power supply system delivers power to the distribution system. The trains collect their propulsion power from the distribution system by means of pantographs or third rail current collector shoes, and return the power to the substations via their wheels by the traction power return system.

This section lays down the standards for design and performance and general features of the High Voltage (HV) Electric Power System to be designed, constructed, commissioned and operated by the Concessionaire for the SLR System. The Concessionaire shall supply and commission the SCADA System equipment for the control and monitoring of each high voltage electrical power supply system switching and protection equipment.

A power supply network exclusively for the day-to-day operations (except for the Rail system which shall run solar power) or during any an emergency situation which requires Electricity supply for running of the Rails, to which no other consumer connection is given, shall be applied for and procured from the Tamil Nadu Electricity Department. The traction supply system shall use components and designs proven to be reliable in other similar MTC TRANS systems. Uninterrupted Power Supply (UPS) shall be provided as per requirements.

The total power generated by solar energy is around	20MW power.
Volts (Traction power)	750v dc.
Usage power for functioning the grid	110kV.
Auxiliary load	33 kV/ 750vDC
Main LT Panels	
Power For SCADA	25 kV
Stand-by diesel generator to feed the auxiliary loads in case of power failure from the main supply.	415 volt DC
Auxiliary power for total no of stations (17 stations).	33kV * 17 = 561kW.
Each rail car power consumption/per day.	270kWh



Operating hours: Morning 5:30AM Till Mid Night 11.30PM.	17 Hours
A power generation capacity of 16kWh per hour is necessary for the station to transmit electricity to each railcar.	
Total power consumption (for 14 cars*). * Total no of cars = 14.	270kWh * 12 = 3240kWh
Each Rail Car required power from station to station is	7.8kw
MTC TRANS depart Every 5 minute	5 minute
Total number of stations	36
Total power consumption each rail car	7.8*17*=132.6kw

The system shall be so designed as to provide sufficient reserve whereby failure of any one electrical equipment does not lead to dislocation of supply warranting intervention. The traction system should be sufficient to operate the Trains at designed speeds over the operating routes, negotiating all gradients and curves. This should include starting from stand still on the steepest grade under crush load of 8 persons per sq m of standing space with all seats occupied.

The capacities, ratings and number of equipment proposed to be connected as determined by the Concessionaire through the engineering development, shall be demonstrated to the IE by simulation study and proper engineering for the services envisaged considering the possibility of equipment failures /small functioning. The short circuit levels and load flow studies on the system during normal and abnormal working and failure conditions shall be determined and coordinated for his design of the Traction Sub-station equipment/Power distribution and RSS arrangements. The traction system should not generate, or risk dangerous interactions with any other system.

Facilities/controls should be provided to manage and control safely the electric traction system in all foreseeable conditions. Egress/fire evacuation measures shall be as per NFPA-130 edition, and fire detection and suppression shall be generally as per NBC-2005. The Concessionaire shall develop the system with the approval of the local fire safety organization. Transformers in receiving sub-station shall be provided with on load tap changer. Concessionaire may use transformers in ASS and TSS with off load tap changers. All 33 kV cables shall have FRLS outer sheath.



### **System Overview**

The Concessionaire shall provide a SCADA System for the management of HV (High Voltage) net works and BMS or BAS (Building Automation System) for LV (Low Voltage) networks. The SCADA shall control and monitor receiving traction and auxiliary power sub-station, associated 33kV distribution cable network and DC traction section feeders via track cabins and disconnection switches. The level of automatic reconfiguration will be as required considering the importance of power supply net work.

### **Design Considerations**

Distribution equipment utilized within the temporary electrical distribution system shall incorporate the following features:

- Flexibility in application for repeated use,
- suitability for transport and storage, and
- robust construction to resist moisture and damage; and safety in use.
- All cabling shall be run at high level whenever possible and firmly secured to ensure that they do not present a hazard or obstruction to people and equipment.
- The installation on Site shall allow convenient access to authorized and competent operators to work on the apparatus contained within.

### **Mains Voltage**

- The Site mains voltage shall be as per the Electricity Authority, 415V/ 3-phase 4 – wire system:
- Single phase voltage shall be as per the Electricity Authority, 230V supply and reduced voltages shall conform to BS 7375.

### **Power Supply arrangements**

The DC electric power supply is required by **MTC TRANS** system for the following purposes:

- For running trains:-

The AC electric power supply is required by **MTC TRANS** system for the following purposes:

- For station services e.g. lighting, elevators, escalators, Signalling & telecom, fire fighting and pumping etc.
- For depots and other maintenance infrastructure within premises of **MTC TRANS** system.

The major component of power supply is traction and auxiliary requirements for elevated section.



### **Types of Distribution Supply**

The following voltages shall be adhered to for typical applications throughout the distribution systems:

- fixed plant – 415V/3-phase AC (Auxiliary power station), 6MW DC (In main power station),
- movable plant fed by trailing cable – 415V/3-phase,
- installations in Site buildings – 230V/1-phase,
- fixed flood lighting – 230V/1-phase,
- portable and hand held tools – 115V/1-phase, and
- Portable hand-lamps (general use) – 115V/1-phase.
- The Concessionaire shall carry out any conversion that may be necessary to enable him to use power from his source of supply.

### **Estimation of Power**

The power requirement of a *MTC TRANS* system is determined by peak-hour demands of power for traction and auxiliary applications. The power system has been planned for the ultimate single coach train operation at the headway of 6 minute corresponding to 14 trains per hour. Broad estimation of auxiliary and traction power demand is made based on the following requirements:-

### **Need for High Reliability of Power Supply**

The proposed system is being designed to handle up to 8500 passengers per direction during peak hours when trains are expected to run at about 6 minute's intervals.

The tolerance level of any power interruption during this period is extremely low, as such incidences, apart from affecting train running, will cause congestion at stations. Lack of illumination at stations, non-visibility of appropriate signage, disruption of operation of lifts and escalators is likely to cause confusion, anxiety and ire in commuters, Effect on signalling and communication may affect train operation and passenger safety as well. Accordingly, system requires a high level of reliable and quality of power supply.

### **Cables**

Cables shall be selected after full consideration of the conditions to which they will be exposed and the duties for which they are required. Supply cables up to 33kV shall be in accordance with BS 6346.251. For supplies to mobile or transportable equipment where operation of the equipment subjects the cable to flexing, the cable shall conform to one of the following specifications appropriate to the duties imposed on it.





<b>Battery charging current &amp; duration</b>	<b>Charged energy (at battery terminals)</b>	<b>Running distance after charging (without air conditioning)</b>	<b>Running distance after charging (at the maximum air conditioning load)</b>
1000A _ 61sec.	35.6MJ	Equivalent to 7.9km	4.0 km or over
500A _ 3min.16sec.	56.9MJ	Equivalent to 12.7km	6.4km or over

All cables which have a voltage to earth exceeding 65 V (except for supplies from welding transformers to welding electrodes) shall be of a type having a metal sheath and/or armour which shall be continuous and effectively earthed. In the case of flexible or trailing cables, such earthed metal sheath and/or armour shall be in addition to the earth core in the cable and shall not be used as the sole earth conductor.

Armoured cables having an over sheath of polyvinyl chloride (PVC) or an oil resisting and flame retardant compound shall be used whenever there is a risk of mechanical damage occurring. For resistance to the effects of sunlight, overall non-metallic covering of cables shall be black in colour.

Cables which have applied to them a voltage to earth exceeding 12V but not normally exceeding 65V shall be of a type insulated and sheathed with a general purpose or heat resisting elastomeric.

All cables which are likely to be frequently moved in normal use shall be flexible cables. Flexible cables shall be in accordance with BS 6500 and BS 7375.

All HV power cables shall be XLPE insulated or equivalent, in accordance with IEC 60332 – Part 3 and NFPA 130. Where protection is required suitable ductwork shall be provided. In constrained areas FRLSOH cables shall be provided. Control and Power cables shall be separated throughout the route. All critical, duplicate and/or ring main cables shall be routed separately so that damage to one cable/route will not compromise performance and safety. All cabling and protection equipment shall also comply with the IEC/EN standards as a minimum requirement. All HV power cables shall be XLPE insulated or equivalent, in accordance with IEC 60332 – Part 3 and NFPA 130. Where protection is required suitable ductwork shall be provided. In constrained areas FRLSOH cables shall be provided. All critical, duplicate and/or ring main cables



shall be routed separately so that damage to one cable/route will not compromise performance and safety. All cabling and protection equipment shall also comply with the IEC/EN standards as a minimum requirement.

### **HV Power Supplies**

- The Electric Power supplied by and Tamil Nadu Electricity Department shall generally be, as follows:
- Voltage:  $U_c +10\% / -12.5\%$ , where  $U_c$  is the nominal voltage; and frequency;  $50 \pm 3\%$  Hertz.
- HV Auxiliary Power Supply Systems shall be suitably transformed at each station, to the required voltage.
- Earthing and bonding shall be provided for the electric power system.
- High Voltage supply and Traction Sub Station power supply arrangements shall be finalized by the Concessionaire.
- Normal Train service operation. Manual supervision of the HV network shall be by the Engineering Controller located at the OCC.
- HV Auxiliary Power Supply Systems shall be suitably transformed at each station, to the required voltage.  
Earthing and bonding shall be provided for the electric power system

### **Power Supply System**

Both the sources of supply and transmission and distribution networks shall be reliable, with adequate redundancies built in. It is necessary to obtain power, at least one supply at high grid voltage of 220 or 132 or 66 kV from grid sub-stations. To support the system operations as per the operating plan. The design shall be based on the performance requirements and actual capabilities of the equipment to be supplied.

The system shall provide for:

- Integrity of traction and auxiliary power supplies, and the ability to restore supplies rapidly.
- Ability to re-start services as rapidly as possible after a total failure of traction current supply, particularly to absorb a short-term overload caused by a large share of the Rolling Stock starting within a short period of time.
- Economy in traction energy consumption by regenerative braking.
- Optimum number, capacity and location of sub stations with minimum occupation of space at grade.
- Well designed sub-station buildings.
- Capacity for future system extension without extensive alteration to the existing power supply systems and service interruption on the existing part of the Rail system.
- Switchgear and circuit breakers shall be able to operate on three levels: remote control from OCC, local operation from the substations and manual operation directly on the component.



The power supply system shall be designed for normal operations and contingency operations. The following non-coincidental contingencies shall be assumed:

- Worst case Train delays and Train bunching.
- Failure of one traction sub-station.
- Power feedback from regenerative braking.
- Failure of one utility supply point/interface.
- Abnormal power supply system configuration caused by out-right failures of equipment including feeders, circuit failures and failures of transformers and rectifiers.

UPS system shall be installed to support power supply loads for Depots, essential Station facilities as well as for supporting essential loads of all E&M equipment. The UPS system shall provide high quality AC power to very essential loads under normal and abnormal utility voltage conditions, including power failure. Standby Diesel Generator (DG) Sets Standby DG sets shall be provided at the Stations. They shall cater to the following:

- Essential lighting;
- Signalling & telecommunications;
- fire fighting system;
- lift and escalator operations;
- fare collection system;
- security system; and
- UPS loads.

### **Augmentation**

The system design shall permit augmentation by way of adding main power transformers and traction transformer rectifier sets.

### **Power Supply for – Mahabalipuram at Poonjeri Town**

The power Station is available at 110 kV from 220/110 kV grid sub-station. The place of the substation will be finalized after the kick start of the project. . This Grid sub-station is about 2 km from the Mahabalipuram at Poonjeri Town. Although total requirement of power as per estimate is about 13 MVA, it is proposed to plan substation with 15 MVA. This will be reviewed during detailed design stage when rolling stock paramount of energy requirement are firmed up.

### **Current Carrying Equipment Power Rails**

Current carrying rail of suitable cross section shall be provided on the both sides of the elevated beam of even of 750 V dc some manufacturers follow +375 V while other follow 750 V dc and above.



### Amount of required electric power per rail car

If a railcar arrives and departs every 6 minutes, a power generation capacity of 9.6kWh per hour is necessary for the station to transmit electricity to each railcar. When we assume that the first train of the day is 5:30 a.m. and the last train is 11:30 p.m., the electric power necessary for a day is 270kWh.

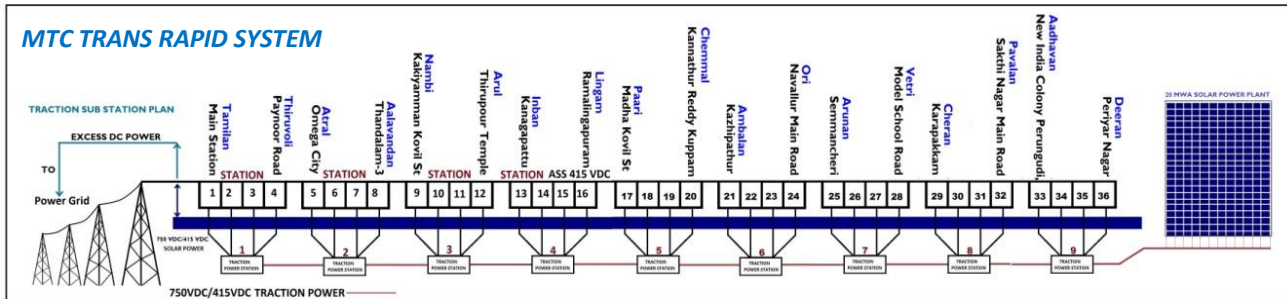

### Rating of Power Supply Cables, Feeders and other details

- For the estimated load 15 MVA appxo, two 3-phase circuits of 66 kV, XLPE insulated 630-mm<sup>2</sup> Aluminium (single core) shall be drawn and laid through public pathways by the MTC TRANS Authority's 110 kV /33 KV/66 kV Grid Sub Station from **Tamilan to Thiruvoli**
- 3-phase circuits of 110 kV, XLPE insulated 630-mm<sup>2</sup> Aluminium (single core) shall be drawn and laid through public pathways by the Authority's 110 kV Grid Sub Station at **Atral to Aalavandan** station
- 3-phase circuits of 110 kV, XLPE insulated 630-mm<sup>2</sup> Aluminium (single core) shall be drawn and laid through public pathways by the Authority's 110 kV Grid Substation at **Nambi to Arul**.
- 3-phase circuits of 110 kV, XLPE insulated 630-mm<sup>2</sup> Aluminium (single core) shall be drawn and laid through public pathways by the MTC TRANS Authority's 110 kV Grid Substation at **Inban to Lingam**.
- 3-phase circuits of 110 kV, XLPE insulated 630-mm<sup>2</sup> Aluminium (single core) shall be drawn and laid through public pathways by the MTC TRANS Authority's 110 kV Grid Sub Station at **Paari To Chemmal** station
- 3-phase circuits of 110 kV, XLPE insulated 630-mm<sup>2</sup> Aluminium (single core) shall be drawn and laid through public pathways by the MTC TRANS Authority's 110 kV Grid Substation at **Ambalan to Ori**.
- 3-phase circuits of kV, XLPE insulated 630-mm<sup>2</sup> Aluminium (single core) shall be drawn and laid through public pathways by the MTC TRANS Authority's 110 kV Grid Substation at **Vetri to Arunan**.
- 3-phase circuits of 110 kV, XLPE insulated 630-mm<sup>2</sup> Aluminium (single core) shall be drawn and laid through public pathways by the MTC TRANS Authority's 110 kV Grid Substation at **Pavalan to Cheran**.



- 3-phase circuits of 110 kV, XLPE insulated 630-mm<sup>2</sup> Aluminium (single core) shall be drawn and laid through public pathways by the **MTC TRANS** Authority's 110 kV Grid Substation at **Deeran to Aadhavan**.

However, the final cable ratings and type will once again be finalized during the kick off period of the project by the project team.

### **Traction Power Supply System**

On elevated Beam, Current carrying Power Rails are to be provided on both sides of the beam (i.e. +ve as well as -ve return rails). The Power rails are insulated from the track beam. Since the path of the **MTC TRANS** everywhere on elevated track beams is completely isolated, free of public and not accessible even to staff other than highly skilled staff with proper permits to work, hence the system is safe.

In the 750V DC or 415V DC Traction **MTC TRANS** due to higher specific energy consumption and lower voltage the traction currents are high. Moreover, number of parallel circuits/ conductors cannot be increased, as there is constraint of running the cables on the viaduct/elevated beam, therefore, the 33KV/66KV distribution network for the Metro Traction system is a proven and time tested technology and have become a norm and ring main systems for both Traction Sub Station feeders and Auxiliary Substation feeders is recommended.

### **Earthing and Bonding**

Since this is four rails system completely separated from the running beam track the adverse effect of corrosion shall not be predominant. Therefore, limited measures shall be required for earthing and bonding.

- The earth leakage and frame leakage relays shall be provided for substation equipment. If the fault current levels are of the order of load currents carrier protection/ pilot wire protection may be required, which may necessitate 4 or 6 pair twisted core shielded cable in addition to the power cables. Pilot wire protection shall also be required for Inter tripping of adjacent HSCBs in case of line faults.
- Floating system has been used by Trans. Thus reduces the dc stray current to considerable level. The arrangement shall comply with following latest CENELEC standards:-
  - EN 50122-1:- Railway Applications (fixed installations) protective
  - Provisions relating to electrical safety & earthing.
  - EN 50122-2:- Railway Applications (fixed installations) protective
  - Provisions against the effects of stray currents caused by dc traction system.





### **Basis for Planning Traction Substations**

The traction substations (TSS) have been planned to keep the voltage drop within permissible limits. The design and capacity of RSS and TSS has been selected to cater for the eventualities of total failure of one Source/feeder, RSS, TSS or a subsystem. The distance between two TSS's is estimated about 3 to 4 km (depending up on voltage drop). Thus, the gap between any two substations will not be more than four-five stations to limit the number of simultaneous starting trains on each TSS. In case of failure of any TSS the feed of the next Traction substation will be extended may require controlling of the trains.

### **Location of Traction Substations**

All the stations will have sub-power stations. These sub-stations will have all the necessary components for battery backup storage, and the initial thrust circuits for making the vehicle to start from dead stop.

### **Selection of Traction Voltage**

The traffic requirements of the MTC TRANS have been projected to be about 5500 and 6200 PHPDT. The corridors will be elevated. For this level of PHPDT technically traction voltage at 750 V dc will suffice. Maglev Magnetic trans are worldwide available with 750V DC systems. The Monorail in Mumbai is using 750V DC. Keeping in view of traffic requirements, aesthetics and other techno-economic considerations, 750V dc type traction systems is considered suitable.

### **Traction Power System**

Traction current shall be supplied to lines in sections, separated by gaps in conductor rails. Sections should be double end fed from Traction sub stations (TSS) except the sections towards a depot which is single end fed.

TSSs shall be sized to accept suitable power over load (minimum 50%) for duration of 2 hours. Traction sub stations along with Auxiliary Sub-Stations (ASS) shall be located in the close vicinities or in the station building inside a room. Additional ASS shall be located at each maintenance Depot. When located outside, it can be underground with safety features as per rules/regulations in force.

Each TSS shall have transformer-rectifier sets of suitable capacity with provision for an additional set to be installed at a future date, in order to supply DC voltage as per design to the third rail. From the TSS, DC cables of required voltage capacity shall be laid up to third rail and return current cables shall be connected to running rails. Self-cooled, cast resin dry type transformer-rectifier shall be provided for indoor application. Transformer and rectifier shall conform to IEC 61000, IEC 60146, EN 50327, EN 50328 and EN 50329.



Single phase XLPE insulated cables with minimum 400 mm sq. copper conductor or equivalent or more as per design requirement shall be provided for transfer of power from TSS to third rail. Number of cables required depends on power requirement.

Traction supplies shall be distributed at 750V DC or as per design voltage in accordance with IEC 60850, Railway Applications – Supply Voltages of Traction Systems. 750V DC Stringer type of current collection systems shall be provided in Depot.

Traction sub-stations (TSS) shall be set up for feeding DC power supply as per design to the third rail. They shall be distributed all along the line so as to be evenly loaded so that the line will not be subjected to voltage levels unacceptable to the Rolling Stock in the event of shut down of a TSS. TSS may be installed for stations and one for the Depot. The number, capacity and configuration of the traction sub stations shall be decided by the Concessionaire in consultation with the IE to meet the overall reliability, availability and technical requirements.

- The third rail design shall be in accordance with BS 7865, EN 50122-1 and EN 50122-2.
- The third Rail and interface equipment shall be protected from switching surges and lightning strikes.
- The third rail is designed so that in the event of a single failure of a mechanical element the system shall not cause a hazard and wherever practicable allow continued operation of the Rail System.
- Third Rail system and equipment with a proven history of service on similar Rail Systems shall be employed.
- The Third rail conductor shall comply with international standards and shall have a continuous rating commensurate with power supply rating in still air at the highest maximum ambient temperature and solar radiation levels to be expected on the Rail System. This rating shall be achieved without exceeding the Third Rail conductor maximum temperature.

Control and monitoring of track circuit breakers provided for energizing the third rail shall be carried out from the ATS part of the OCC. Additionally, OCC shall have the control to trigger an Emergency de-energizing of the entire line or a section there of.

### **Auxiliary Power Supply System**

The ASS's is provided in all the station premises and power to the auxillary substations are received from the main sub-stations. All the stations are connected through cabling from the ASS.

The auxiliary power will be required for:

- Stabling sidings.
- Platforms.
- Service buildings.



- Stairs/Concourse.
- Maintenance depots.
- Traction substation buildings.
- Ventilation & Air-conditioning.
- Elevators – Machine Room less Elevators, for 8/13 Passengers 1 m/sec speed.
- Escalators, Elevator & Escalator provision is kept for future at all the stations.

### ***Basis of Planning Auxiliary Sub Stations (ASS)***

#### ***Station load***

2x350KVA ASS of 33KV/66KV/110KV/750 V DC or 33KV/66KV/110KV/415 V DC with DG sets and UPS have been planned for station loads except at some stations where commercial development may derive power of 500 KVA. Each Station shall be provided with an independent ASS. The demand of power at each elevated station is expected to be about 300 KW.

### ***Auxiliary Supply Substations (ASS – For station electrical utilities purpose only)***

#### ***Power Transformers***

Power Transformers shall be in accordance with EN 60076. Two transformers shall be provided in each ASS, configured for redundant operation.

- (i) Elevated/at –grade station load –300KW (to serve future provision of Elevators and Escalators at each station) and for stations with commercial development, it will be 350 KW.
- (ii) Final Depot auxiliary load - 1050 KW.

### ***Electricity board practices and Limitations for ASS***

This project aims in providing ASS's near the main sub-station. All the stations are connected through cabling from the ASS.

If there is going to be some limitations and practical scenarios where the ASS should be kept in all station premises only, then each station shall be provided with an ASS with two indoor type 33kV/750V, 3- phase, 350 kVA transformers and the associated HT & LT switchgear and for commercial development stations 500kVA transformers shall be provided. The demand is based on level of services required at the stations given in the following section. The ASS will be located at mezzanine or at station platform level inside a room.

### ***Performance Specification for ASS***

#### ***Auxiliary Power Supply System***

The Concessionaire shall provide a 33kV 3-Phase ring-main circuit within the Rail system infrastructure, providing redundant connections to Auxiliary Sub-station (ASS) at each station, Depot a Two ASS transformers shall step down the 33kV 3-phase to 415V 3-phase and 240V 1-phase supplies. Each transformer and associated switchgear shall normally supply part of the ASS



load and in the event of a failure or maintenance activities, one transformer shall automatically assume the full load of the ASS.

The ASS control panel fast acting protection equipment shall monitor the transformers and switchgear performance and immediately enable the isolation of defective equipment. Each ASS shall be supervised by the Engineering Controller at the OCC, via the SCADA System. The SCADA System shall automatically re-configure the Auxiliary Power System during failure and maintenance activities alarm the Engineering Controller, record power consumption and maintain a log of events.

### ***Selection of Supply Voltage for Receiving (Main) Sub-Station***

To ensure reliability of power supply, it is essential that supply is taken at least from two sources and the connected transmission networks are reliable and have adequate redundancies built in. Grid substation voltage available in Tamil Nadu is at 110 KV and 66 KV. Therefore, it is proposed to obtain power supply at grid voltage of 110kV or 66kV from stable grid sub-stations and further transmission & distribution to the stations along the corridor will be by the MTC TRANS Maglev Magnetic Authority itself. Whether reliable 33 KV ring is available in the city is not known. It will be ascertained when the project kicks off.

### ***Location of Receiving (Main) Substation***

The city has 220kV- 230kV grid supply at periphery of the city at Grid substation, where it is stepped down to 110kV. The power supply to this Grid sub-station is from Area code Generating station.

The 110kV supply is stepped down at Tamil Nadu Power Station Grid sub -station to 33/66kV level. The power supply to this grid substation is reliable as it is connected to:

- Grid.
- Generating station.

### ***Sub-station Equipment***

- An RTU shall be provided at each RSS and ASS sub-station to communicate with the central SCADA servers. The RTU shall interface with the Remote Input/Output (RI/O) units of which the field equipment to be monitored or controlled are connected.
- A Local Control Panel shall be provided in each sub-station for the monitoring and control of all the equipment associated with a particular RTU. For the event of loss of the OCC, a fall-back arrangement shall be provided to enable the supervision of the entire Electric Power System.



### **Energy Saving Measures**

Energy charges of any system constitute a substantial portion of its operation & maintenance (O & M) costs. Therefore, it is imperative to incorporate energy saving measures in the system design itself. The auxiliary power consumption of metros is generally more than the traction energy consumed by train movement during initial years of operation. Subsequently, traction power consumption increases with increase in train frequency/composition in order to cater more traffic.

**MTC TRANS** includes the following energy saving features:

- Modern trans rolling stock with 3-phase VVVF drive and lightweight coaches has been proposed, which has the benefits of low specific energy consumption and almost unity power factor.
- Rolling stock has regeneration features and it is expected that 20% of total traction energy will be regenerated and fed back to 750 V dc third rails to be consumed by nearby trains.
- Effective utilization of natural light is proposed. In addition, the lighting system of
- the stations will be provided with different circuits (33%, 66% & 100%) and the relevant circuits can be switched on based on the requirements (day or night, operation or maintenance hours etc).
- Machine-room less type lifts with gearless drive has been proposed with 3- phase VVVF drive. These lifts are highly energy efficient.
- The proposed public services escalators will be provided with 3-phase VVVF drive, which is energy efficient & improves the power factor. Further, the escalators will be provided with infrared sensors to automatically reduce the speed (to idling speed) when not being used by passengers.
- The latest state of art and energy efficient electrical equipment (e.g. transformers, motors, light fittings etc) has been incorporated in the system design.
- LED lighting is proposed in certain areas. Efficient energy management is possible with proposed modern SCADA system by way of maximum demand (MD) and power factor control.

### **Electric Power Tariff**

The cost of electricity is a significant part of operation & maintenance (O&M) charges of the **MTC TRANS** system, which constitutes about 30-35% of total annual working cost. Therefore, it is the key element for the financial viability of the project. The annual energy consumption is assessed to be about 32 million units in the horizon year (2041). It is proposed that takes necessary steps to project as a special category of consumers whose tariff should be based upon the actual cost of supply, excluding both the subsidy and cross-subsidy elements i.e. at 'No Profit





No Loss' basis. This is expected to be in the range of Rs. 3.50 – 4.00 per unit, so that the annual energy bill can be substantially reduced.

***MTC TRANS services deserve this on the considerations given below:-***

**MTC TRANS** is to be executed as a public utility and a social sector green field project with a view to improve mobility of commuters and reduce congestion and pollution on roads and faster travel at affordable rates for which electricity is the only source of energy for operation and system and if constitutes about 1/3rd of cost of operation & maintenance.

- For this power supply will be taken at 110kV or 66kV grid points of TEB.
- Further transmission and distribution for **MTC TRANS** operation at 750 V DC / 415 V DC and other passenger services is through 33kV network of MMDDRTS with built in redundancies to ensure reliable supply for the system.
- For **MTC TRANS** will be setting up 2 Receiving Sub-stations at 110kV and 66kV and 33kV sub-station and cabling at their cost.
- It will not utilize local authorities' distribution network.
- It will not attribute any losses below 66kV. It will only contribute in redundancy losses of distribution system of local authorities.
- During peak hours, there will be 8,000 to 10,000 passengers and any disruption of supply will inconvenience passengers. For this MMDDRTS will provide built redundancies at their cost. Similar approach has been adopted in Delhi and Bangalore where MRTS is working.

***Metering***

The OCC equipment shall comprise the Engineering Controller workstation, mimic panels Digital Light Processing (DLP) unit or other systems, conforming to the Specifications set out in this Manual, displaying the entire Traction Power System and Auxiliary Power System. Two hot-standby redundant servers shall acquire real time equipment status from the Remote Terminal Unit's (RTU), process operator commands and perform the core SCADA functions. Any change of state of an input shall be reported at the OCC within 4 seconds of the occurrence.

Any System reconfiguration time shall not exceed 10 seconds.

***Protection for Safety against electrical shocks***

- Protection facilities with fast discrimination and reliable operation, based on micro-processor technology, shall provide the protection scheme logic. The zones of protection shall overlap providing back-up protections. The scheme for protection shall be fully coordinated.
- The Concessionaire shall ensure that discrimination between all forms of Station substation protection is such that equipment failures cause minimum disruption to the Rail System operation.



- An interlocking and protection scheme that prevents inadvertent or spurious re-energisation of the supply shall be ensured.
- The Earthing system shall conform to EN 50122-1 Railway Applications-Fixed Installations. Protective Provisions Relating to Electrical Safety and Earthing and EN 50122-2. Railway Applications-Fixed Installations.
- Protective Provisions against the effects of stray currents caused by DC traction systems.
- The Earthing System for Stations, Depot and Line-side structures shall comply with the BS 7430 Code of Practice for Earthing.
- At Stations and line-side structures, copper earth mats and connecting conductors shall be used. Down conductors fixed to viaduct columns, connecting the Structure Earth mat/spike to the viaduct bus bar may be provided as Aluminium.

### **System Earthing**

Earthing and bonding equipment shall be embedded in the civil structures. System protective earthing for providing electrical safety at Stations, substations, line-side buildings shall be provided. The Concessionaire shall engineer the earthing system on the basis of safety for people against hazardous touch and step potential and fire hazards and in accordance with provisions of IEC-61936.1. Power Installations exceeding 1kV AC, IEC 60364-4-41: Low voltage Electrical Installations. Part 4-4 Protection for Safety against electrical shocks, and NFPA 130.

The Earthing system shall conform to EN 50122-1 Railway Applications-Fixed Installations. Protective Provisions Relating to Electrical Safety and Earthing and EN 50122-2. Railway Applications-Fixed Installations. Protective Provisions against the effects of stray currents caused by DC traction systems. The Earthing System for Stations, Depot and Line-side structures shall comply with the BS 7430 Code of Practice for Earthing. At Stations and line-side structures, copper earth mats and connecting conductors shall be used. Down conductors fixed to viaduct columns, connecting the Structure Earth mat/spike to the viaduct bus bar may be provided as aluminium.

Earthing and bonding shall be provided for all electrical installations and equipment to prevent the possibility of dangerous voltage rises and to ensure that faults are rapidly cleared by installed circuit protection.

- Earthing systems shall conform to the following standards: IEE Wiring Regulations (16th Edition).
- BS 7430.
- BS 7375 and IEEE Standard 80 Guide for Safety in AC Substation Grounding.



### **Earth System conductance**

Structure Earthing System for viaduct sections of the track the equi-potential bonding of the metallic re-inforcing in stations and line-side buildings shall be connected to the associated Building Earth System specified in Chapter 11. Viaducts shall be sectionalized at, approximately two beam lengths, and the Bonding of metallic reinforcing in viaduct structures, slab-track bed; handrails, and the like, shall be connected to a common Structure Earth.

### **Electrical Protection Systems**

Protection facilities with fast discrimination and reliable operation, based on micro-processor technology, shall provide the protection scheme logic. The zones of protection shall overlap providing back-up protections. The scheme for protection shall be fully coordinated.

The Concessionaire shall ensure that discrimination between all forms of Station substation protection is such that equipment failures cause minimum disruption to the Rail System operation.

An interlocking and protection scheme that prevents inadvertent or spurious re-energisation of the supply shall be ensured.

### **Protection of Circuits**

Protection shall be provided for all main and sub-circuits against excess current, under and over voltage, residual current and earth faults. The protective devices shall be capable of interrupting (without damage to any equipment or the mains or sub-circuits) any short circuit current that may occur.

- Discrimination between circuit breakers and fuses shall be in accordance with:
- BS 88.
- BS EN 60898.
- BS 7375 and any other appropriate Indian Standards.

### **Insulation Coordination**

Equipment shall have insulation levels according to EN 50124, Railway Applications – Insulation co-ordination.

### **Operational energy**

Strategies for minimizing energy use and maximize energy efficiency include:



## **MTC TRANS**

- Reduced aerodynamic resistance.
- Regenerative braking.
- Reduced weight of trains (aluminium car bodies and lighter propulsion equipment reduces weight).
- Humped tracks (to assist braking and acceleration at stations).
- Optimize track alignment and grading.
- Demand ventilation control – target temperature modified to improve energy efficiency and maintain comfort conditions.
- Energy efficient lighting.

### **Stations**

- Passive environmental control system (natural ventilation and day lighting).
- Energy efficient environmental control system (demand operated ventilation and alternatives to air conditioning).
- Maximum use of stairs rather than escalators (dependent on station depth).
- Energy efficient lifts and escalators.
- Sensor operated escalators.
- Energy efficient lighting.
- Integrate solar photovoltaic cells/thermal within building structures.
- Building orientation.
- Improved building fabric energy efficiency and review building specifications,
- Developments related to stations to ensure that new buildings reduce overall energy demand, including ancillary facilities, retail areas and operation/maintenance areas.

### **Stabling yards and depot**

- Passive natural ventilation system.
- Day lighting.
- Energy efficient lighting.
- Energy efficient plant.
- Hybrid/fuel cell maintenance vehicles/plant.
- Integrate solar photovoltaic cells/solar thermal within building structures.
- Energy efficient lighting.

### **Thermal and ventilation modeling**

Thermal and ventilation modeling should be conducted to understand the likely performance of the stations, depot and trains and thereby to determine requirements for climate control systems.



Climate control performance standards should then be set and the options for meeting these standards assessed, taking into account the energy efficiency of the various options available.

### **Energy modelling**

Energy modeling should be undertaken to calculate and anticipate energy consumption based on the findings of this feasibility study. This will provide a baseline from which to measure energy consumption throughout the life of the project. As the design is refined, this baseline can be updated to document the energy savings which can be delivered through energy minimization and efficiency strategies as well as opportunities for generating energy from renewable and low carbon sources.

### **Materials minimization and resource recovery**

Materials minimization and resource recovery strategies

- The **MTC TRANS** aims to conserve materials (by minimizing resource use and maximizing resource recovery) and minimize the environmental impact associated with the resources consumed where possible through implementation of the following strategies.
- Developing and implementing sustainable procurement policies with the construction working group and contract administrators.
- Providing reuse and recycling training and facilities in stations, depot and offices for use by staff.
- Providing reuse and recycling training and infrastructure at construction sites.
- Setting construction reuse and recycling targets and monitoring waste generated to determine where improvements can be made.
- Beneficially reusing 100% of useable spoil.
- Promoting the use of design for flexibility and deconstruction principles.
- Promoting minimal resource use as a design target.

### **General**

Investigate use of alternative energy sources and the use of renewable energy during operation of the **MTC TRANS**. Commit to purchasing a set percentage of energy from a renewable source during operation.

### **Life Cycle Analysis**

Life cycle analysis could be undertaken to calculate the embodied materials, energy, waste and emissions from materials consumed in construction of the **MTC TRANS**. This will assist in materials selection and provide a baseline from which to measure the project's performance in terms of materials over its full life cycle, including requirements for refurbishment and ultimately disassembly and reuse/recycling of project components.





Life cycle analysis should include analysis of use of recycled materials in construction and opportunities for reducing embodied energy and waste and also creating markets for recycled materials. Whole of life cost would form an element of this life cycle analysis.

### ***Biodiversity***

Enhancing biodiversity as part of the **MTC TRANS** will be a challenge given the highly urbanized nature of the areas affected. However there are opportunities for biodiversity improvements through increasing vegetation during and after construction to provide shade, improve micro-climate and air quality and enhance the overall urban aesthetic (e.g. landscaping, vertical gardens/green walls/bio walls).

### ***Community and Stakeholder Engagement***

Actively engaging the community and stakeholders should promote public support for the project and maximize patronage. To achieve these objectives, the following strategies should be implemented:

Develop a strategy to actively engage the community in design of the stations and station precincts and the public realm to optimize way-finding, access, facilities and the quality of customer experience

Investigate opportunities for obtaining funding for sustainability initiatives from other sources, including government grants programs and funds (e.g. Green Precincts Fund).

### ***Sustainability Management System***

A system of sustainability governance will need to be established at the outset of the next project stages to set the direction and guide the process of integrating sustainability considerations into the design, construction and operation of the **MTC TRANS**. Implementation of a sustainability management system would provide clear definition of sustainability objectives and targets and enable processes and project team responsibilities to be defined along with systems of monitoring and performance reporting.

### ***Fire Protection requirements***

All requirements in respect of fire protection shall be as in Part IV, Fire Protection in National Building Code of India, 1983 and amendment No.3 under Fire Protection Annexure II. Therefore, the provision of NBC will prevail for **MTC TRANS** at CHENNAI.

In view of above, the pump/hydrant, hose reel, and fire fighting systems have been reviewed. The details have been covered in the relevant chapter in DPR. The fire fighting system envisaged at



**MTC TRANS** elevated station contains:-

- Internal hydrant.
- Sprinklers.
- Detectors.
- Manual call box.
- Manual panel gas flooding.

**Overall Need 20 Megawatt power**

<b>Year-2019, Traction power requirements</b>	
No of cars	2 rail coach
Section length	42 KM
Headway	6 minute
Specific Energy consumption	75 KW/hr/1000GTKM
No. of trains/hr in both directions	20
Peak traction power requirement	5.9 MW
Less Regeneration	@ 20% 1.2 MW
Depot power requirements	0.3 MW
Total traction power requirement	5.0 MW
Total traction power requirement energy losses and	(MVA) assuming 5% .95 pf 5.5MVA
Station aux power requirements	
Elevated/at-grade station--power consumption	0.30 MW
Elevated/at-grade station--power consumption with PDLoad0	.35 MW
No. of elevated/at-grade stations	36
Elevated station with PD Load	4
Total Station Aux Power requirement	4.7 MW
Depot Aux power requirement	1.1 MW
Total Aux Power requirement	5.8 MW
Total aux power requirement (MVA) assuming 5% energy losses and .85 pf for aux loads	7.1MVA
Total traction & aux power requirement (MVA)	12.6MVA



## 17 - SIGNALLING AND TRAIN CONTROL

### Introduction

The Signalling System for MTC TRANS system will provide the means for an efficient train control, ensuring safety in train movements. It enables optimization of infrastructure investment and running efficient train services with scalable headway on the network.

### Overview

The MTC TRANS System carries large number of passengers at close headway requiring a very high level of safety enforcement and reliability. At the same time heavy investment in infrastructure and rolling stock necessitates optimization of its capacity to provide the best services to the public. These requirements of the Mono Rail are planned to be achieved by adopting Communication based Train Control (CBTC) generally conforming to IEEE 1474 and ATS (Automatic Train Supervision) Sub-systems. Signalling and Train Control System will be capable of running trains at operational headway up to 120 seconds (the design headway of 100 sec). This will:

- Provide high level of safety with trains running at close headway ensuring continuous safe train separation.
- Eliminate incidences of Signal passing at Danger by continuous speed monitoring and automatic application of brake in case of violation of MSS, disregard of signal aspect / MSS by the Train Operator.
- Enforces speed limit on section having permanent and temporary speed restrictions. Improve capacity with safer and smoother operations. Driver will have continuous display of Target Speed in his cab enabling him to optimize the speed potential of the track section. It provides signal / speed status in the cab even in poor visibility conditions.
- Increased utilization of rolling stock by increasing line capacity, train speeds and headway. Hence more trips will be possible with the same number of rolling stock and civil infrastructure.
- Improve maintenance of Signalling and telecommunication equipments by monitoring system status of trackside and train borne equipments and enabling preventive maintenance. Signalling & Train Control system on the line shall be designed to meet the required headway during peak hours.

### System Description and Specifications

The Signalling and Train Control system shall be as below. Sub-system/ components will conform to international standards like CENELEC, IEC, IEEE, IS, ITU-T etc:

### Continuous Automatic Train Control

Continuous Automatic Train Control will consist of - ATP (Automatic Train Protection), ATO (Automatic Train Operation) and ATS (Automatic Train Supervision) sub-systems:



### **Automatic Train Protection (ATP)**

Automatic Train Protection is the primary function of the train control systems. This subsystem will be inherently capable of achieving the following objectives in a fail-safe manner. Line side signals will be provided, which shall serve as back-up Signalling in case of failure of ATP system. In such cases, train speed will be automatically restricted to 25 kmph.

- Cab Signalling.
- Track Related Speed Profile generation based on line data and train data continuously along the track.
- Continuous monitoring of braking curve with respect to a defined target point...
- Monitoring of maximum permitted speed on the line and speed restrictions in force
- Detection of over-speed with audio-visual warning and application of brakes, if necessary.
- Maintaining safety distance between trains Monitoring of stopping point.
- Monitoring of Direction of Travel and Rollback.
- Support De-graded mode of operations for particular train/Area of Control.
- The cab borne equipment will be of modular sub-assemblies for each function for easy maintenance and replacement. The ATP assemblies will be fitted in the vehicle integrated with other equipment of the rolling stock.

### **Automatic Train Operation (ATO)**

This system will operate the trains automatically from station to station while remaining within the safety envelope of ATP & open the train doors. Driver will close the train doors and press a button when ready to depart. In conjunction with ATP and ATS, ATO will control dwell time at stations and train running in accordance with headway/ timetable.

### **Driverless Train Operation**

In a driverless operation system, trains run without a driver on board. Train operation and status is remotely controlled and adjusted from the OCC based on the two-way Radio Frequency-Communication Based Train Control (CBTC). This high-end system can minimize faults and operation delays through securing redundant systems and automatic route change functions. This operation system also ensures safety through minimizing human error, which accounts for the largest portion out of the cause of railway accidents. The term ATO is used to cover a wide range of levels of automation, from the automation of the basic driving operation alone to the running of trains with no staff member on board. The universally adopted concept for identifying the level of automation is levels of “Grade of Automation” (GOA), with GOA level I being ATP only with no ATO.



The Semi-automatic Train Operation (STO) or GOA level 2 refers to ATO which enables trains to run automatically from one station to the next, under the protection of an ATP system and under the supervision of a train driver. With STO, the driver remains in the cab of the train, operates the doors, provides the start signal for the train to leave a station, and monitors the performance of the train and the track ahead.

The next level of automation is referred to as Driverless Train Operation (DTO) or GOA level 3. In DTO, the driver is able to move away from the front of the train, but remains available to provide help to the customers facing difficulties and to drive the train in the event of a failure of the ATO system. In DTO, train doors and train departure from a station platform may be controlled automatically or manually from a location other than a drivers cab at the front of the train.

Driverless ATO without an on-board attendant is referred to as Unattended Train Operation (UTO) or GOA level 4. UTO can range from empty train movements only (to a siding, or in an automated depot for example) to the operation of trains in passenger service with no attendant on board. Driverless operation system is universalized and is operated over 100 transit lines around the world. The automation level in Mass Transit System proposed is GOA level 3 (DTO) with availability of trained staff in train.

### ***Benefits of Driverless Train Operation***

Train operation is automated by pre-arranged programs, and is committed to providing safe and faster transport service for passengers via OCC equipped with cutting-edge technology through:

- Decrease in safety accidents incurred by human error.
- Increase in efficiency of operating personnel.
- Observation of external view from inside the train.
- Reduction in energy consumption.
- Cost-efficiency and consistent operation.
- Less congestion due to maximum train operation during revenue operation hours.
- Prompt switch-over of a leading cab during train turn-back (Multifunctional personnel reduction cost in the long run).
- Flexible Train operation.

### ***The apprehension associated with driverless train operations are:***

- Handling of failures on a driverless train car.
- Anxiety of passengers for a driverless train car.





### ***Handling of failures on a driverless train***

The problem of attending a failure on a driverless train is of utmost concern as it poses a serious constraint on the operations. This can be resolved by:

Posting a trained attendant in trains to attend and act as first line maintenance support and by establishment of emergency transportation tools and systems for dispatch to an incident site at designated stations. Besides, mobile maintenance teams can also be deployed at such stations to ensure that the failure situation is promptly attended and the impact is minimized.

### ***Anxiety of passengers for a driverless train***

The driverless trains are now well adopted the world over. Still, the idea of a train without a driver is something which the public is not very comfortable with, at least initially. To overcome this anxiety the implementation of driverless train will be done in a phased manner. Initially, the trains will run in ATP mode which is a driver driven mode, then ATO will be implemented which again has a driver. Lastly, in the final phase, the trains will be run driverless, albeit with a trained staff, having a train driver license in order to address possible anxiety of passengers and immediately deal with any train faults. Driverless Train Operations is being adopted the world over. The driverless operation offers advantages of quicker turnaround, better throughput and no dependence on the human factor. Hence it is proposed to adopt driverless operation in

## **MTC TRANS**

### ***Automatic Train Supervision (ATS)***

A train supervision system will be installed to facilitate the monitoring of train operation and also remote control of the station. The train supervision will log each train movement and display it on the work stations with each Traffic Controller at the OCC and on one work station placed in the Station Control room (SCR) (at interlocked stations) with each Station Controller.

The Centralized System will be installed in the Operation Control Centre. The OCC will have a projection display panel showing a panoramic view showing the status of switches, signals and the vehicles operating in the relevant section/ whole system. ATS will provide following main functionalities:

- Automatic Route setting.
- Automatic Train Regulation.
- Continuous Tracking of train position.
- Display Panel & Workstation interface.
- Adjustment of station dwell time.
- Link to Passenger Information Display System for online information.
- Computation of train schedules & Timetable.



### **Computer Based Interlocking (CBI)**

Computer Based Interlocking (CBI) will be provided for operation of switches and setting of routes at the Two Terminal Stations (Thiruvanmiyur Periyer Nagar to Old Mahabalipuram Poonjeri via State Entrance), New Bus Stand station and Depot.

The setting of the route and clearing of the signals will be done by work station, which can be either locally (at station) operated or operated remotely from the OCC., either manually by the Traffic Controller or automatically by ATS. This sub-system is used for controlling vehicle movements into or out of stations automatically from a work station. All stations having switches will be provided with work stations for local control. Signal status, Switch position, etc. will be clearly indicated on the work station. It will be possible to operate the work station locally, if the central control hands over the operation to the local station. The interlocking system design will be on the basis of fail-safe principle.

The equipment will withstand tough environmental conditions encountered in a Mass Transit System and suitable for weather conditions in CHENNAI, Control functions in external circuits will be proved both in the positive and negative wires. Suitable IS, IRS, IEEE, BS Standards or equivalent international standards will be followed in the case of wiring, installation, earthing, cabling, power supply and for material used in relays, switch operation machine interfaces, power supply etc.

### **Train detection**

Radio Communication based Train detection will be used for vehicle detection.

### **Switch operation and detection interface**

Necessary interfaces for operation of switches and their detection by interlocking will be provided. For the proposed Signalling plan attached as annexure, the position of switch can be at a distance of 10 m from the edge of the nearest platform. CCTV coverage on all the switches is proposed with two cameras per switch, covering the complete switch. This will help the OCC/SC to ascertain the condition of switches in case of any point failure and will also be helpful in remote monitoring of the switches.

### **Headway**

- The Headway calculations are based on two components namely, the inter-station headway and the turn back headway. The inter-station headway is typically the time when the lead train has just cleared the station stopping point, after the dwell time, by sufficient margin, to allow the following train to place its target point at the station stopping point.



- The turn back headway is similar to inter-station headway, but also accounts for the time needed for route initiation, switch operations required for crossing to opposite track, travel time over point zone and any other associated delays.

With smaller train length, straight run, sufficient inter-station run time and multiple trains in section, the inter-station headway is always better than the turn-back headway. Thus the ruling constraint in headway consideration is turn back headway which is calculated on the following assumptions:

**Track Data**

- The maximum operating speed is assumed to be 80km/h.
- Total switch move time is assumed to be 10 seconds.
- The dwell time is defined as wheel stop to wheel start at all stations.
- Defined as 20seconds for all stations.
- The maximum speed over Crossover Track is assumed to be 30 km/h.

**Train Depot: Signalling**

All Depot lines, except the ones used for shunting in workshop, shall be interlocked. A work station shall be provided in the Depot Control Centre for operation of switches, signals and routes of the depot yard. Train detection will be radio based. Line side signals for diverging routes will be provided.

**Standards**

The following standards will be adopted with regard to the Signalling system.

<b>Description</b>	<b>Standards</b>
Interlocking	Computer based Interlocking adopted for station having switches and crossing. All related equipment as far as possible will be centralised in the equipment room at the station. The depot shall be interlocked except for lines mainly used for shunting, workshop/inspection shed areas.
Operation of switches	Through interface from interlocking
Train detection	Communication based
Signals at Stations with switches	Line Side signals to protect the switches. LED type signals for reliability and reduced maintenance cost.
UPS (uninterrupted power at stations as well as for OCC)	For Signalling, Tele-communications and AFC



Train protection system	Automatic Train Protection system (CBTC) with fall back arrangement for Train Control, generally, as per IEEE 1474 or equivalent.
ATO and Driverless operation	Will be introduced in phased manner
Train Describer System	Automatic Train Supervision system. Movement of all trains to be logged on to a central computer and displayed on work stations in the Operational Control Centre and at the SCR of interlocked stations. Remote control of stations from the OCC.
CCTV Coverage of Switch	Switches will be covered using two CCTV cameras on each switch for remote monitoring.

<b>Description</b>	<b>Standards</b>
CCTV coverage in Train Coaches	The train coaches will have CCTV cameras for surveillance, to remotely access the situation and issue instructions to passengers if needed.
Redundancy for TP/ Train Describer.	Redundant Train borne equipment and ATS equipment at OCC.
Cables	Outdoor cables will be steel armoured as far as possible.
Fail Safe Principles	SIL-4 safety levels as per CENELEC standard for Signal and Train control application.
Immunity to External Interface.	All data transmission on telecom cables/OFC/Radio will have suitable means of immunity to external environment. All Signalling and telecom cables will be separated from power cables. CENELEC/IEEE standards to be implemented for EMC/jamming.
Train Working under emergency/degraded mode	Running on site with line side signal with speed automatically restricted at 25 kmph.
Environmental Conditions	Air-conditioners for all equipment rooms.



### **Independent Safety Assessor (ISA)**

Independent Safety Assessor would be required to audit the Signalling system and suppliers' processes and approve the same for Safety certification. There are no local ISA's available in India. An ISA will have to be engaged for the **MTC TRANS Mono Rail**.

### **Space Requirement for Signalling Installations**

Adequate space for proper installations of all Signalling equipment at each of the stations has to be provided keeping in view the case of maintenance and use of instrumentation set up for regular testing and line up of the equipment/system.

- The areas required at each of the stations shall be generally :
- For Signalling equipment room at interlocked station with switches - 50 sq.m for UPS Room (common for Signalling and telecom) - 50 sq.m

The OCC will be located in the Depot. The ground floor will accommodate S&T Equipment and UPS. First floor will be used for OCC Theatre. At the OCC, the areas required shall be:

- For OCC theatre- 250 sq. m.
- Signal and Telecom equipment room at OCC: 250 sq. m.
- Central computer and NMS for AFC system: 100 sq. m.
- Communication System supervisor - 36 sq. m.
- UPS room at OCC: 50 sq. m.
- Space for S&T spares storage in depot: 100 sq. m.
- The Depot control centre (DCC) equipment will be co-located with S&T equipment at OCC. DCC will be accommodated in the OCC theatre. All the rooms will be air-conditioned. The OCC theatre will also accommodate CCTV monitoring by Security personnel. These areas shall also cater to local storage and space for maintenance personnel to work.

### **Maintenance Philosophy for signalling systems**

The philosophy of continuous monitoring of system status and preventive & corrective maintenance of Signalling and telecommunication equipments shall be followed. Card / module / sub-system level replacement shall be done in the field. Maintenance personnel shall be suitably placed at intervals and they shall be trained in multidisciplinary skills. Each team shall be equipped with a fully equipped transport vehicle for effectively carrying out the maintenance from station to station. The defective card/ module / sub-system taken out from the section shall be sent for diagnostic a centralized S&T repair lab suitably located on the section. This lab will be equipped with appropriate diagnostic and test equipments to identify the faults and undertake minor repairs. Cards / modules / equipments requiring major repairs as specified in suppliers documents shall be sent to manufacturer's workshop.





## **The Telecommunication**

The telecommunication system acts as the communication backbone for Signalling systems and other systems such as SCADA, AFC etc and provides telecommunication services to meet operational and administrative requirements of metro network.

### **Overview**

The telecommunication facilities proposed are helpful in meeting the requirements for,

- Providing back bone for the Signalling system for efficient train operation.
- Exchange of managerial information.
- Passenger information system.
- Crisis management during emergencies.
- The proposed telecom system will cater to the following requirements.
- Train Traffic Control.
- Maintenance Control.
- Emergency Control.
- Station to station dedicated communication.
- Telephone Exchange.
- Integrated Passenger Announcement System and Passenger Information.
- Display System within the station and from Central Control to each station.
- Centralized Clock System.
- Instant on line Radio Communication between Central Control and Moving Cars and maintenance personnel.
- Data Channels for Signalling, SCADA, Automatic Fare Collection etc.
- E&M SCADA and Access Control is not envisaged as part of Telecomm System.

### **Telecommunication System and Transmission Media**

#### **Fiber Optic System (FOTS) - Main Telecommunication Bearer**

The main bearer of the bulk of the telecommunication network is proposed with optical fiber cable system. Considering the channel requirement and keeping in view the future expansion requirements a minimum 48 Fibre optical fiber cable is proposed to be laid in ring configuration with path diversity.

SDH (STM-16) based system shall be adopted with SDH nodes at every station and OCC. Access 2MB multiplexing system will be adopted for the lower level at each node, equipped for channel cards depending on the requirement of channels in the network. Further small routers and switches shall be provided for LAN network at stations. Additionally totally IP Based High Capacity, highly reliable and fault tolerant, Ethernet Network (WAN/LAN) shall be provided for data intensive sub-systems like CCTV, SAP, etc.



### **Telephone Exchange**

For an optimized cost effective solution, extension for telephonic communication up to 30 ports shall be planned at each station. The Exchanges at Central Control and Depots shall be of larger sizes as per the actual number of users. The Exchanges will serve the subscribers at all the stations and Central Control. The exchanges will be interconnected at the channel level on optical backbone. The exchanges shall be software partitioned for EPABX and Direct Line Communication from which the phones shall be extended to the stations.

### **Mobile Radio Communication**

Mobile Radio communication system having up to 8 logical channels is proposed for online emergency communication between Motorman (Front end and Rear end) of moving train and the Central Control. The system shall be based on Digital Trunk Radio Technology to TETRA International standard. All the stations, DCC and the OCC will be provided with fixed radio sets. Mobile communication facility for maintenance parties and Security Personnel will be provided with hand-held sets. These persons will be able to communicate with each other as well as with Central Control.

- To provide adequate coverage, the RF site survey to be carried out during detailed Design stage. Base stations for the system will be located at sites conveniently selected after detailed survey. Tentatively minimum 1 BTS shall be positioned every third station. The frequency pairs shall require concurrence of WPC.
- In addition to the TETRA Radio Coverage for the internal critical use of the Metro, GPRS/CDMA Mobile should be used for O&M activities.
- It is expected that coverage shall be available from the adjoining sites of the Mobile Operators.

### **Passenger Announcement System**

The System shall be capable of announcements from the local station as well as from OCC. Announcements from Station level will have over-riding priority in case of emergency announcements. The System shall be linked to Signalling System for automatic train actuated announcements.

### **Passenger Information Display System**

These shall be located at convenient locations at all stations to provide bilingual visual indication of the status of the running trains and will typically indicate information such as destination, arrival/departure time, and also special messages in emergencies. The boards shall be provided at all platforms and concourses of all stations. The System shall be integrated with the PA system.



**Centralized Clock System**

This will ensure an accurate display of time through a synchronization system of slave clocks driven from the existing Master Clock at the Operation Control Center. The existing master Clock shall be expanded to cater for this. The Master Clock signal shall also be required for synchronization of FOTS, Exchanges, Radio, Signalling, etc. The System will ensure identical display of time at all locations. Clocks are to be provided at platforms, concourse, Station controller Room, Depots and other service establishments etc.

**Closed Circuit Television (CCTV) System**

The CCTV system shall provide video surveillance and recording function for the operations to monitor each station. The monitoring shall be possible both locally at each station in SCR and remotely from the OCC. CCTV System shall be provided for platforms and station building entrances for all station with 10 Cameras per station. The exact number of Cameras may slightly vary and will be decided based on station layout. The CCTV system backbone shall be based on IP technology and shall consist of a mix of Fixed Cameras and Pan/Tilt/Zoom (PTZ) Cameras. Cameras shall be located at areas where monitoring for security, safety and crowd control purpose is necessary.

**Network Monitoring and Management**

For efficient and cost effective maintenance of the entire communication network, it is proposed to provide a network management system (NMS), which will help in diagnosing faults immediately from a central location and attending the same with least possible delay, thus increasing the operational efficiency and reduction in manpower requirement for maintenance. The proposed NMS system will be covering Radio communication, Optical Fiber Transmission, Telephone Exchange and summary alarms of PA/PIDS, CCTV and Clock System. PTCC (Power and Telecom Co-ordination Committee) clearance would be required for resolving power and telecom lines issues before commissioning.

**Technology**

The Technologies proposed to be adopted for telecommunication systems are shown in Table below:

<b>System</b>	<b>Standards</b>
Transmission	Optical Fibre system as the main bearer for bulk of the telecommunication network.
Telephone change	EPABX extensions up to 30 ports are to be provided at
Train Radio	each Station. Digital Train radio (TETRA)



System	communication between motorman of moving cars, stations, maintenance personnel and central control.
Train Destination Ind	LED/LCD based boards with adequate visibility to be provide convenient location at all stations to provide bilingual visual indic of the status of the running trains, and also special message emergencies.
Centralized clock system	Accurate display of time through a synchronization system of slave clocks driven from a master clock at the OCC and sub – master clock in station. This shall also be used for synchronization other systems.
Passenger Announcement System	Passenger Announcement System covering all platform and concourse areas with local as well as Central Announcement.
Redundancy (Major System)	Redundancy on Radio's in the Base Stations,Path Redundancy for Optical Fibre Cable by provisioning in ring configuration.
Environmental Conditions	All equipment rooms to be air-conditioned.
Maintenance Philosophy	System to have, as far as possible, automatic switching facility to alternate routes/circuits in the event of failure. Philosophy of preventive checks of maintenance to be followed. System networked with NMS for diagnosing faults and co- ordination. Card/module level replacement shall be done in the field and repairs undertaken in the central laboratory/manufacture's premises.

**Space Requirement for Telecom Installations**

Adequate space for proper installations of all Telecommunication equipment at each of the stations has to be provided keeping in view the case of maintenance and use of instrumentation set up for regular testing and line up of the equipment/system. The areas required at each of the stations for Telecom equipment shall be 40 Sq. m. for Telecom Room and 50 Sq. m. for UPS Room (common for signal, telecom and AFC).These areas shall also cater to local storage and space for maintenance personnel to work. At the OCC, the areas required shall be as per the final configuration of the equipment and network configuration keeping space for further expansion



## **18 - AUTOMATIC FARE COLLECTION**

### **Introduction**

MTC TRANS Systems handle large number of passengers. Ticket issue and fare collection play a vital role in the efficient and proper operation of the System. To achieve this objective, ticketing system shall be simple, easy to use/operate and maintain, easy on accounting facilities, capable of issuing single/multiple journey tickets, amenable for quick fare changes and require overall lesser manpower. In view of above, computer based automatic fare collection system is proposed. For Multiple Journey, the Store Value Smart Card shall be utilized and for the Single Journey, the media shall be Contactless Smart Token. AFC system proves to be cheaper than manual system in long run due to reduced manpower cost for ticketing staff, reduced maintenance in comparison to paper ticket machines, overall less cost of recyclable tickets (Smart Card) in comparison to paper tickets and prevention of leakage of revenue. The AFC equipment shall be provided at each station at convenient locations and will be connected to a local area network with a computer in the Station Master's room.

### **Auto Top Up Through Debit Card**

The commuter will apply for registration of his account by mentioning his details as well as card engraved ID. The account will be activated after due verification from the bank and card data base by the AFC system. Now the user will be able to use this account to make 'add value' in his AFC card and the transaction can be carried out from the debit card through the bank payment gateway. The AFC card will get charged whenever the user shows his card at nominated AFC equipment at station.

### **Choice of Control Gates & Passenger Operated Machine**

Retractable flap type Control Gates are proposed which offer high throughput, require less maintenance and are latest in modern metros internationally. Tripod turnstile type gates offer less throughput and require more maintenance and hence are not proposed.

At all stations, minimum two Passenger Operated Machines (Automatic Ticket Vending /Add Value Machines) each are proposed. The POM's will provide convenience to passengers to avoid standing in queues at ticket booths and provide them international level service.

### **Ticket fare**

<b>Distance in Kms</b>	<b>Fare in 2019 (Rs.)</b>
0.2	10.00
2-4	12.00
4-6	15.00
6-9	18.00
9-12	20.00
12-15	22.00





## 19 - SAFETY & SECURITY

### Safety concept

Despite high speeds, passengers are safer in maglev vehicles than in other transportation systems. The electromagnetically suspended vehicle is wrapped around the guideway and therefore virtually impossible to derail. Elevated guideways ensure that no obstacles can be in the way. MMDDRTS systems are required by law to guarantee construction and operation of a system that meets proper safety standards. The responsibility of MMDDRTS systems are schematically shown in Fig.

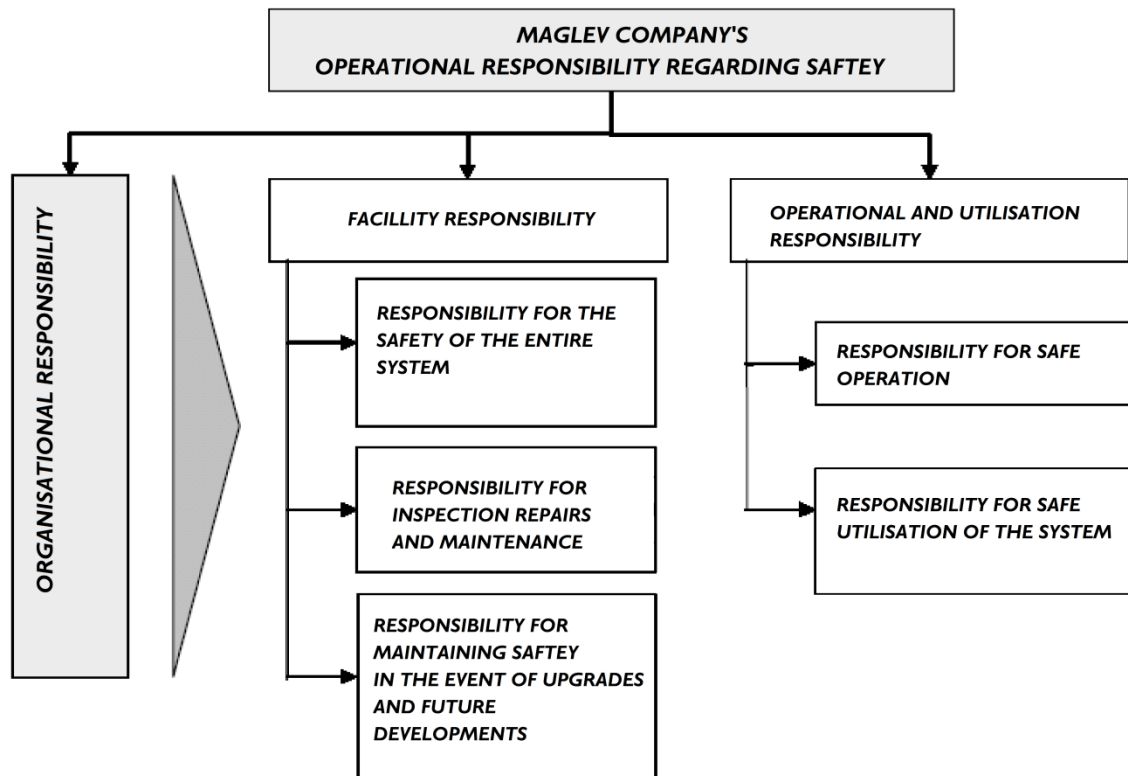

### Maglev system's responsibility

### Rescue concept

An essential component of the safety concept is the rescue concept. The MMDDRTS vehicle operator has to explain in this concept with which measures self and external rescue shall be guaranteed. Depending on conception self and/or external rescue measures require different sizes of escape routes, places for emergency stops and accessibilities. Therefore, the rescue concept influences the extent of the required properties so that the effects on the planning approval procedure are given immediately.



The examples of protection against going off and rescue concept clearly show how safety concept and planning approval are connected with each other. This means that the development of a safety concept must be at the beginning of the planning process of a MMDDRTS system. However, changes of the route course may occur because of others than for safety reasons, so that corresponding customizations of the safety concept can become necessary at a later date.

The factors affecting transportation safety and security are various, among which, the physical structure and guideway security patrols play significant roles. Elevated guideways can be operated safety and efficiently. A means will be required to transfer passengers from the emergency walkway to the ground unless rescue vehicles are used to remove passengers from the walkway. The proposed method of egress from the emergency walkway is a pair of hinged stairways located within one guideway span where the walkway beam would be discontinuous. The stairways would be hinged at the end of the walkway beam and would be attached to dampers that would control the lowering of the stair. The passengers would need to activate a manual release mechanism and then the stair would lower by gravity, slowed by the dampers. The stairways would need to be located at intervals that are a reasonable walking distance.

### ***Passenger Safety and Evacuation***

The MTC TRANS will be fully automated (no drivers) with central control from facilities adjacent to the guideways. Security personnel, by means of audio-visual communication, would view the vehicles inside at all times, during unloading and loading as well as while traveling on the guideway. Laser beams on-board the vehicle will control any irregularities or emergencies on the guideway and bring the vehicle to a stop if needed. Special vehicle escape devices i.e. each car contains a provision wherein an emergency slide way passage is in-built for the passengers to evacuate (as shown in the figure) from elevated guideways.

### ***Operation control system (OCS)***

The OCS comprises all technical facilities for planning, monitoring and safeguarding of vehicle operation which means a combination of automatic vehicle operation (ATO) and automatic vehicle protection (ATP) functions like e.g. providing a safe vehicle travel path in order to avoid collisions and the monitoring of vehicle travel speed range in order to assure stopping only at predefined stopping points. The OCS consists of central, wayside and mobile components with interactions to other sub-systems respectively operational and maintenance staff.

The structure of the OCS is as shown below.

Operation control system (OCS) is the part of an overall MMDDRTS system that integrates all subsystems like operation control center, guideway elements, stations, maintenance areas, propulsion and power supply, and vehicles.



An OCS contains all components and functions to control and monitor the safe MMDDRTS operation. OCS allows control of the vehicle movements and guideway elements both manually and automatically. On the base level, OCS provides all the safety functions generally known in railway Signalling, e.g. vehicle locating, guideway switch control, route protection (interlocking), and automatic vehicle control including speed monitoring.

### Functional Block Diagram of OCS

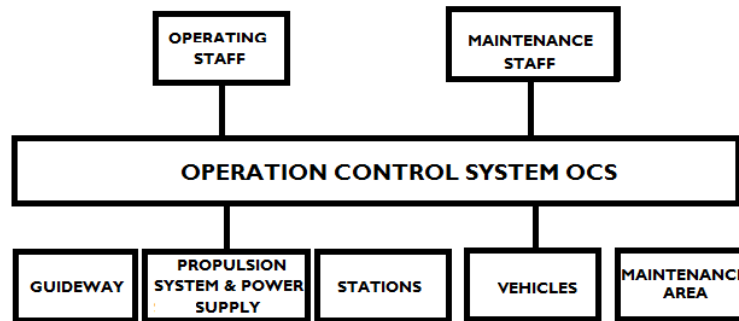

### **Reliability, Availability, Maintainability and Safety**

An important issue in the proper operation of rapid transit systems is the reliability, availability, maintainability and safety (RAMS). RAMS is the item that needs to be considered in any new rapid transit system establishment. This item is the factor that affects the passenger’s mode choice decisions and is important for project evaluation.

MMDDRTS is one of the safest means of transportation in the world. The concept of MMDDRTS has essentially eliminated the safety risks associated with the operation of conventional rail systems. The use of a dedicated and separated guideway without intersections with other transportation modes such as roads and highways ensures no safety conflicts and allows uninterrupted MMDDRTS operations. The MMDDRTS technology has essentially eliminated the safety risks associated with the operation of rapid transit systems. Compared to the operating experiences of conventional railway system, the MMDDRTS technology has a scarce record.

### **Energy consumption and space requirement**

With non-contact technology, there is no energy loss due to the wheel-guideway friction. The vehicle weight is lower due to the absence of wheels, axles and engine (low mass of approx. 0.5 t per seat). In terms of energy consumption, the MMDDRTS vehicles are better than conventional trains. As consumers of energy, the transportation sectors are vulnerable to environmental and global warming concerns and the increasing volatile oil market. Reducing dependency on foreign oil is also an important criterion. The system of the external power supply over the contact rail causes higher investment and operational costs.



### **Pollution**

As MMDDRTS is electrically powered, there is no direct air pollution as with airplanes and automobiles. The MMDDRTS causes lower CO<sub>2</sub> emissions. It is also easier and more effective to control emissions at the source of electric power generation rather than at many points of consumption. MMDDRTS is the quietest transportation system available today. Due to its non-contact technology, there is neither rolling nor gearing or engine noise. The frictionless operation of the MMDDRTS vehicle reduces vibration and maintenance resulting from wear.

### **Loading**

In this part of research, MMDDRTS guideways and road and railroad bridges are compared from loading and design aspects. The optimal design of all bridges, including road, railroads and MMDDRTS elevated guideways is really vital. Majority of the existing MMDDRTS guideways are elevated and completely built on the bridge. In fact, a MMDDRTS elevated guideway is one kind of bridges. Therefore, it can be compared with any bridge, including railroad and road.

### **Customer Safety and Security**

Customer safety and security will be of prime importance for all aspects of the MTC TRANS operation. Passenger safety must be all-encompassing from the fundamentals of design through to the fire alarm system, Signalling system and rolling stock. Stations and other public areas will give people a sense of safety and security by incorporating light and open spaces into relevant designs. Crime Prevention through Environmental Design (CPTED) principles will be employed to reduce the levels of crime and help to provide a safe environment. Customer safety and security will be achieved through a combination of proven station and rolling stock design, fully integrated systems and a safety management policy that ensures:

- All staff are trained to deal with a wide range of situations and emergencies,
  - Station and train staff maintain a high level of visibility to provide customer confidence,
  - Good use is made of the equipment available e.g. the ticket gates are used to control crowding and the presence of CCTV is well advertised to act as a deterrent,
  - Effective systems integration to promote safe operation of the maglev trans,
  - Operational processes that are simple to understand and implement,
- Safety targets are in line with international best practice and are systematically monitored and managed, and
- Efficient and effective use of the Group Station Control Rooms and Operations Control Centre to co-ordinate key activities, processes and systems.



### **Employee Safety**

Employees, contractors and Emergency Services personnel when engaged in activities on must be able to carry out their duties during normal and degraded operations without risk of injury or ill-health. This will be achieved, through risk reduction and harm minimization processes, safe systems design and safe operating practices. Staff training will ensure that personnel understand their duty of care to themselves and others. It will also equip them to deal with conflict and deal with aggressive behaviour. In the event that the On Train Customer Service Assistant has to drive the train, a protected area will be provided to segregate the Assistant and reduce risk of interference and distraction while in control of the train.

### **Group Station Control Rooms**

The current station system architecture and design has been developed using the foreign model of Group Station Control rooms, where one control room monitors typically 3 or 4 stations. This provides ability for local control and monitoring of station plant and equipment of adjacent stations and a back up facility to the OCC if required. The control room staff will be able to respond to incidents such as people stuck in a lift, but their time away from the control room will be limited. There is an opportunity to explore an alternative arrangement with control from the OCC supported by a single back-up station control room. This avoids the need to resource multiple station control rooms and will be further investigated during concept design.

### **Safety And System Assurance**

A suite of Key Performance Indicators will be developed to cover the following areas and deliver a culture of continuous improvement:

- Customer Complaints per thousand journeys,
- Customer Satisfaction (survey results),
- Station and train cleanliness and presentation,
- Levels of ticket less travel, gating and ticket machine availability,
- Quality of manual announcements on station and on train,
- Punctuality, reliability and passenger delays,
- Infrastructure punctuality and reliability impacts,
- Staff availability and attitude,
- Patronage,
- **Chennai Old Mahabalipuram Road** maps of the stations available on request, and Audible announcements of the next train and the destination





### **Customer Service Centre**

Given the size of, it is not practical to set up a bespoke customer service centre. It is therefore proposed that this function and that of lost property is contracted out to a specialist customer contact handling and lost property company and that the service is paid for per contact/ per item basis. Customers will also be able to obtain information from the Transport Info line.

The Operations Controller will be responsible for providing up to date information to the website, Info line and customer contact handling company. The Customer Service Managers will also assist the contact handling company with complaints. The customer contact centre will be available 07:00-19:00 Monday to Friday and 08:00 – 16:00 on Saturdays, Sundays and all Public Holidays except Festival season. A recorded message service is available outside of these hours. Details of opening hours and contact details will be made available on train, at stations and on the website. Customers will be encouraged to email or call the centre as opposed to writing in to ensure a rapid response. Customer complaint targets will be developed and senior managers within the business will be encouraged to review complaint summary reports and 10% of complaints each period to understand the nature of the service failures and to implement corrective actions

### **Communications**

DC Substation entry alarm monitoring and equipment panel door monitoring

The general philosophy is that all systems can be monitored at the OCC but only those systems that are operationally critical (which includes those that are safety critical) would be controlled from the OCC. Control of non-operationally critical systems would reside locally at station, group station control rooms (GSCRs) and/or infrastructure locations. Systems monitoring and control within the OCC will be the responsibility of a single “Technical Controller”. This function will be discrete (and at a separate workstation) from any Train Control function. The role will also undertake condition monitoring of rolling stock. Stations and other infrastructure locations will have appropriate local control panels but these will not be actively monitored locally. Monitoring of groups of stations will rest with the GSCRs

The **MTC TRANS** is an enabling element for a network. Its capacity is defined by the ability to cater for future extensions and the requirement to carry the morning and afternoon peak demand in both directions through. Considerations of future capacity requirements and alignment extensions have shown that a single-bogies train set is the optimal solution. This is to provide capacity for 50 passengers. The peak frequency of services is anticipated to be 10 trains per hour, moving to 10 trains per Customer ease of use will be a priority on a number of levels

- Readily available information will be provided regarding services and amenities in the station environs.



- A simple way-finding policy will deliver signage that is clear, easy to read and caters for all modes of arrival at the station, a range of languages spoken and impairments. Advertising, retail and non-essential signage will not impair way-finding.
- Customers with reduced mobility will be able to access and use the station independently through the provision of lifts.

Accessing the **MTC TRANS** Convenient access and interchange is critical to success. The stations will be safe, well lit and visually appealing. Each station will be designed for easy access, providing access for pedestrians and cyclists with appropriate bicycle storage, and interchange to rail and/or bus. The stations will also improve connectivity with the local amenities within the **MTC TRANS** boundaries. It will have a strong brand presence based on the Product Principles that distinguish them from other forms of transport whilst demonstrating strong connectivity with existing services. As part of that brand the **MTC TRANS** will have a distinctive and recognizable image and livery. The pricing policy and ticketing system will be easy to understand and simple to use for all types of customers. Clear information will be provided on how to access.

### ***Supervisory Control and Data Acquisition of Systems (SCADA)***

**SCADA** is the acronym for **Supervisory Control and Data Acquisition**. SCADA is a computer-based system for gathering and analyzing real-time data to monitor and control equipment that deals with critical and time-sensitive materials or events. SCADA systems were first used in the 1960s and are now an integral component in virtually all industrial plant and production facilities. We make use of this technology for Electrical power transmission and distribution. The main requirement of these devices includes monitoring equipment voltage and current.

SCADA systems utilize Distribution Control Systems (DCS), Process Control Systems (PCS), Programmable Logic Controller (PLC) and Remote Terminal Units (RTU) that perform the majority of local and remote process alarming, monitoring and control.

There will be a fully integrated approach in respect to the installed systems on the

- **MTC TRANS** will be a common platform which would allow control and monitoring from generic operator workstations. Some examples of the types of systems to be integrated that includes ATO/ ATP systems,
  - Bulk supplies, HV reticulation, traction supplies, general M&E power supplies,
  - Station systems such as lifts, air conditioning, power supplies, pumping, fire systems,
  - Lighting,
  - Automatic ticket gates,
  - Performance monitoring systems (or modules attached to other systems)



Incident reporting and monitoring systems (e.g. passenger injuries, assaults operational incidents).In addition, SCADA systems are needed to monitor and control a large geographical displacement where an organization may not have enough manpower to cover. Thus, reliable communication and operability of these areas or sites is critical to profitability.

The SCADA system shall record any events caused by faults, malfunctions, warnings or alarm information generated automatically by the selected equipment.

A central recording system shall be provided to record the following events.

- Change of state of RTU input parameters,
- events designated as alarms, faults, control actions, and System generated messages, e.g., equipment malfunction etc.

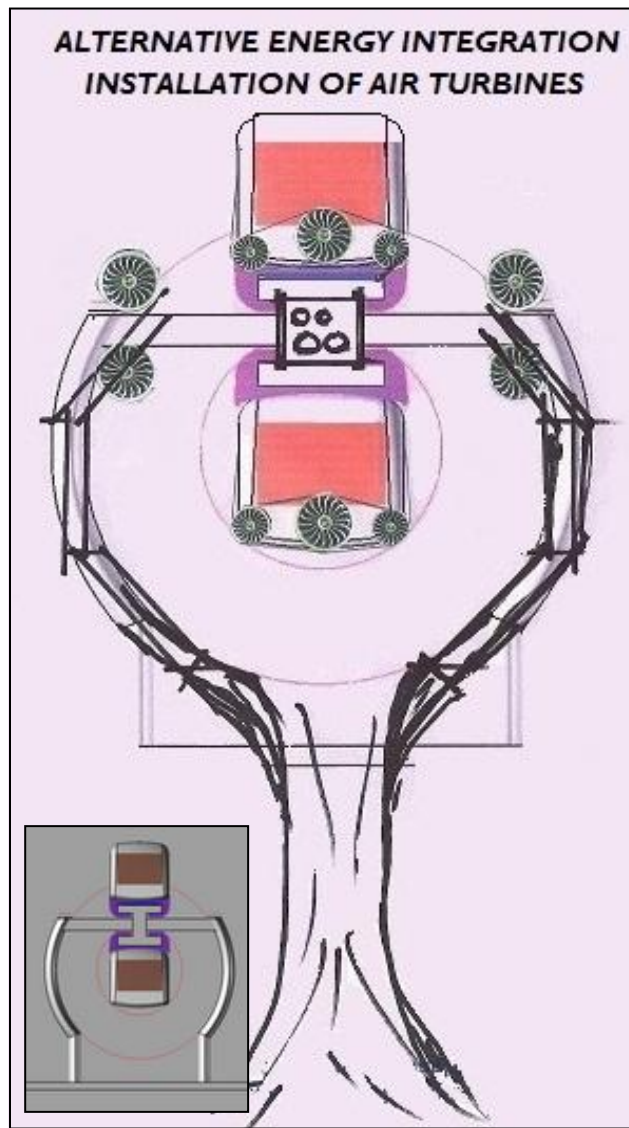

**IAT- Maglev Magnetic Double Decker Transrapid System Single Beam Patent Document**



## 20 - FUNDING

**IAT- Innovative Assess Team** will be able to source 100 % funding for the project support of IMF willing to be a part of this highly innovative transportation project to be implemented in India. The one being "IAT - Innovative Assess Team", based in Germany. They have the patent rights for the MMDDRTS system. They will possibly be our infrastructure partner for the project.

### Cost Estimate

Cost of civil structures has been estimated based on Tamil Nadu State PWD schedule of rates (revised 2010) which came into effect from 01.04.2016. The total cost of the project based on April 2016 price level works out to Rs 3246 crores excluding taxes of Rs 678 crores. He completion cost of this project comes to Rs. 3924 crores with central taxes.

### After the completion the project expenses

Particulars	No.of persons	Expenses	Sub station	Total	Months /Days	Total
Salary	10	20,000.00	36	7,200,000.00	12	84,400,000.00
repairs& Maintenance		40,000.00	36	1,400,000.00	12	17,280,000.00
Electricity		50,000.00	36	1,800,000.00	12	21,600,000.00
Other Expenses		25,000.00	36	900,000.00	12	10,800,000.00
<b>Total</b>				<b>11,300,000</b>		<b>136,080,000.00</b>

### Expenses

SL						
<b>1.00</b>	<b>LAND</b>					
	Station Land Ground Space	4,800.00	6,000.00	28,800,000.00	36.00	1,036,800,000.00
<b>2.00</b>	<b>ALIGNMENT AND FORMATION</b>					
	Elevated Pillar & mid span earaction charges	9,500,000.00	1,680.00			15,960,000,000.00
<b>3.00</b>	<b>STATION BUILDINGS</b>					
	Station Construction A Side (4800*3)	14,400.00	3,500.00	50,400,000.00	36.00	1,814,400,000.00
<b>4.00</b>	<b>E &amp; M WORKS</b>					
	Lifts A & B Stations with lifts and escalators	9,000,000.00	36.00	2.00		648,000,000.00
<b>5.00</b>	<b>DEPOT</b>					



	E & M Cost					68,000,000.00
	M & P cost	-	-			20,000,000.00
	Civil Cost	-	-			480,000,000.00
<b>6.00</b>	<b>SWITCHES</b>					
	Only Switches (Mainline) Including Motor Stools Traction & Power Supply Incl. Ohe, Ass Etc.	900,000.00	3.00			2,700,000.00
	Elevated	67,000,000.00	42.00			2,814,000,000.00
<b>7.00</b>	<b>SIGNALLING &amp; TELECOM</b>					
	Signalling	900,000.00	42.00			37,800,000.00
	Telecom	300,000.00	42.00			12,600,000.00
	Automatic Fare Collection	230,000.00	36.00	4.00		33,120,000.00
	Guide Way Metal Fixing	10,000.00	42,000.00			420,000,000.00
	Land For Power Plant 100 Acres	1,500,000.00	100.00			150,000,000.00
	Solar Plant 250 Watt Panel Plant Accessories, <b>58,73,77,400*6.5=20 Megawatt Power Cost</b>	48,000.00	80,000.00			3,840,000,000.00
	Solar Panel Guidway Fixing	20,000.00	42,000.00			840,000,000.00
<b>8.00</b>	<b>R &amp; R Incl. Hutments And Road Restoration Etc.</b>	100,000.00	36.00			3,600,000.00
<b>9.00</b>	<b>Misc. Utilities, Other Civil Works Such As Median, Road Restoration Etc.</b>	200,000.00	36.00			7,200,000.00
	Electrical Utilities					100,000,000.00
<b>10.00</b>	<b>Rolling Stock Required For This Extension</b>	80,000,000.00	Each	24.00		1,920,000,000.00
<b>11.00</b>	<b>Staff Qutarters For O&amp;M</b>					
	Labor Salary 36Months	500.00	300.00	36.00	365	1,971,000,000.00
	Admin executives Salary					13,737,600.00
						32,192,957,600.00
	<b>Contingencies @ 3 %</b>					965,788,728.00
						33,158,746,328.00
	<b>Taxes</b>					7,626,511,655.44





**After the completion the project revenue**

<b>Train per hr</b>	<b>Station</b>	<b>Average Occupancy</b>	<b>No. of ways of each train per day</b>	<b>Average Fare</b>	<b>Fare revenue per day</b>	<b>No. of days</b>	<b>Yearly revenue</b>
14	36	150	2	100.00	7,560,000.00	365	2,759,400,000.00

**After the completion the project expenses**

<b>Particulars</b>	<b>no.of persons</b>	<b>Expenses</b>	<b>Substation</b>	<b>Total</b>	<b>Months /Days</b>	<b>Total</b>
Salary	10	20,000.00	36	7,200,000.00	12	86,400,000.00
repairs & Maintenance		40,000.00	36	1,440,000.00	12	17,280,000.00
Electricity		50,000.00	36	1,800,000.00	12	21,600,000.00
Other Expenses		25,000.00	36	900,000.00	12	10,800,000.00

**Advertisement Revenue**

<b>No. Of Stations</b>	<b>No. Of Advertisement</b>	<b>No. Of Trains</b>	<b>Charge Per Ad</b>	<b>Revenue Pm</b>	<b>No. Of Months</b>	<b>Annual Revenue</b>
36	3	0	5000	240,000.00	12	2,880,000

**ATM space in station Revenue**

<b>Total No. Of Atm</b>	<b>Rent Per Month</b>	<b>Rental Income P.M.</b>	<b>Months</b>	<b>Rental Income P.A.</b>
15	10,000.00	150,000.00	12	6,480,000.00

**Shops income**

<b>Total No. Of Stations</b>	<b>RentPer Month</b>	<b>No. Of Shops</b>	<b>Rental Income P.M.</b>	<b>Months</b>	<b>Rental Income P.A.</b>
36	5,000	3.00	540,000.00	12	6,480,000 .00



**Details of Taxes and Duties**

<b>Details of Taxes and Duties</b>	<b>Total cost without Taxes &amp; duties (Cr.)</b>	<b>22.85%</b>	<b>12.50%</b>	<b>14.00%</b>
<b>Description</b>		<b>Customs</b>	<b>Excise</b>	<b>VAT</b>
Elevated Pillar	1,596,000,000		1,995,000,000	2,234,400,000
Station Construction	1,814,400,000		22,675,000	254,016,000
Lifts and escalators	648,000,000		81,000,000	90,720,000
Depot Civil Cost	480,000,000		60,000,000	672,000,000
E & M Cost	68,000,000	15,538,000	8,500,000	9,520,000
M & P Cost	200,000,000	47,500,000	25,000,000	28,000,000
Switches & Motor Stools	2,700,000		337,500	37,800
Elevated	2,814,000,000		351,750,000	393,960,000
Signalling	37,800,000	850,500	472,500,000	52,920,000
Telecom	12,600,000	2,879,100	1,575,000	1,764,000
Automatic Fare	33,120,000		4,140,000	4,636,800
Guideway frame fixing	420,000,000			
Solar Plant & Accessories	3,840,000,000			
Taxes included				
Electrical Utilities	100,000,000			
Rolling Stock	1,120,000,000			
<b>Total</b>	<b>2,752,85,73,100</b>	<b>66,767,600</b>	<b>3,022,477,500</b>	<b>3,689,394,800</b>
<b>Tax only</b>				<b>6,778,639,900</b>

**Admin executive's expenses**

DGM (Material Management)	49800	36	1792,800
Manager (Administration)	45000	36	1620,000
Manager (Training Institute)	45000	36	1620,000
Manager (OCC)	45000	36	1620,000
Asst. Chief Controller	34800	36	1252,800
Section Engineer Mechanical/Civil/Electronics)	30000	36	1080,000
Section Engineer – Stores	30000	36	1080,000
Crew Controller/Line Supervisor	30000	36	1080,000
Train Operator /Train Instructor	18000	36	648,000
Superintendent – (HR & Admn)	18000	36	648,000
Assistant - HR	12000	36	432,000
Assistant - Accounts	12000	36	432,000
Store Keeper	12000	36	432,000
<b>Total</b>			<b>13,737,600</b>



**INR & \$**

<b>Cost Estimate</b>	<b>INR</b>	<b>\$</b>
Total project Cost without tax	31,392,957,600.00	\$470,000,000
Details of Taxes and Duties	6,778,639,900	\$10,1383,373
Contingencies @ 3 %	941,788,728.00	\$14,253,867
After the completion the project expenses	136,080,000.00	\$2,059,096
After the completion the project revenue	2,759,400,000.00	\$41,757,446
Advertisement Revenue	2,880,000	\$43,586
ATM space in station Revenue	6,480,000.00	\$98,069
Shops	6,480,000.00	\$98,069
Admin executive's expenses	13,737,600	\$207,935

**Passenger Planning Assumptions**

Train Composition :	Two rail car
Passenger Carrying Capacity (@ 6 persons per square meter of standee area)	Approx. in the range of 100 to 108.
Passenger Carrying Capacity (@ 8 persons per square meter of standee area)	Approx. in the range of 130 to 145.
(ii) Coach requirement has been calculated based on headway during peak hours. (ii) Coach requirement has been calculated based on headway during peak hours. (iii) Traffic reserve is taken as one train to cater to failure of train on line and to make up for operational time lost. (iv) Repair and maintenance reserve has been estimated as 8 % of total requirement (Bare +Traffic Reserve). (v) The calculated number of rakes in fraction is rounded off to next higher number. (vi) Schedule speed is taken as 30 kmph. (vii) Total Turn round time is taken as 6 min at terminal stations.	

**Planning Assumptions**

Note 1: No. of persons per Sub – Station.

Note 2: Total Salary cost of all Sub – Station (B\*C\*D).

Note 3: No. of persons per Terminal and Main Station / Cost per Terminal and Main Station.

Note 4: No. of Months / Days.

Note 5: (E+G)\*H.

General Note: 1) The above expenses are exclusive of INTEREST cost.

2) A, B, C, D, E & F = Assumptions for calculations.

Please note that these cost estimates are based on the following planning assumptions.



### **Trains and Control Systems**

Four-minute train frequency at peak hours, eight-minute train frequency at nonpeak times, a Smart Card fare collection system, and fully automated operations.

### **Beams, Columns, Foundations**

Seventh five-mile guideway with columns that are narrower and spaced farther with funds to improve column appearance. Emergency walkway along the guideway, premiums for nighttime construction to minimize construction impacts on nearby properties and streets, and staging tracks at which trains could be held ready during major events

### **Water Crossings**

Only One Canal Is a Water Crossing.

### **Maintenance Facility**

Basic design and function, and co-location of control center, maintenance facility, and headquarters in the same building.

### **Utilities**

All utility relocation costs and some undergrounding of electrical wires are given to a division of actual relocation work between the City and private contractors.

### **Rights of Way**

Market value paid on the limited number of properties that must be acquired, some easements to be purchased, and high-value properties resold when construction is completed.

### **Power Supply**

MTC TRANS provides energy efficient transit and power solutions to reduce costs and increase air quality, safety, and connectivity using sustainable energy. The MMDDRTS system offers safety, reliability and evacuation in emergencies. It also provides high speeds, at a low cost, with minimal disruption to the natural environment. The integrated transport maglev magnetic trans approach, which composes of pre- and on-carriage for collection and delivery, terminal operation and main haulage including the management of the whole chain. Technical aspects takes into consideration the innovations developed by the Partners. This regards transshipment systems and advanced handling, terminal management and identification, location & positioning techniques, rolling stock design.



### **Design and Administration**

Covers all design work, bonding and insurance, contractor profits, needed overhead and administrative costs, and a public art program. Assumes that work would be completed by union contractors paying living wages to their workers, and that a comprehensive labour agreement would be developed. The cost estimate proposed by the UITPI includes a contingency for each item in the budget. These contingencies were set at different levels depending on the level of certainty or uncertainty of each item's cost. The contingency for trains and control systems, for example, is only 5%, as the cost to construct train cars and control systems is relatively certain

### **Reserve for construction escalation**

The costs listed above have been estimated in 2016 dollars i.e. 1\$ = INR 67. However, inflation over time means that the costs of labor and materials will rise each year. This reserve provides a fund that was estimated based on the region's construction cost inflation level.

### **Train frequency**

17 hours per day, seven days per week, approximately 6 minutes between trains during peak periods (3 hours in both morning and afternoon) and special events, approximately 8 minutes between trains during non-peak periods (remaining weekday hours, weekends, holidays).

### **Pre-construction planning/design**

During the time before procurement documents for a design-build contract can be issued, the **INNOVATIVE ACCESS TEAM** would be responsible for pre-design work and for conducting detailed environmental and preliminary engineering studies for the **MTC TRANS** Project.

### **Civil Structures**

The metal guide tracks, for up and down tracks, are carried over square pillars of about 1.0 diameter generally located along the median of the road. Every 35 meters each pillars and pier heads have a minimum clearance of 15 m above the road level. The single sides of stations are proposed for the project at all the facilities and technical rooms are housed outside the right of way and only platforms are provided over the road supported by pillars located on the median of the road. The access to the station is provided from outside the right of way. All stations will have elevators for old and physically challenged persons. All stations will have fire detection and fire fighting arrangements as prescribed in the National Building Codes.

Minimum distance between track magnetic guide centers has been kept as 5 meter. On curves, distance has been increased based on the additional clearances needed for mid throw and end throw as well as for super elevation. The maximum distance between the track magnetic guide beams on a curve of radius of 30 m has been found to be 4.4 m. The minimum radius adopted for the track alignment is 40 m and maximum gradient for the vertical alignment is 6%.





Proper transition curves for the horizontal and vertical curves as well as cants and cant-deficiencies have been worked out and provided as per the best international practices. The cost for civil structures has been worked out based on Tamil Nadu State PWD schedule of rates (revised 2010) which came into effect from 01.04.2011

Estimate details are furnished below:

**Viaduct Civil Structures**

Sl. No.	Item	Quantity/km	Rate in INR	Unit	Amount in INR
1	Pier cap (m 40)	241.54	28562	l cum	68, 98, 865
2	Pier (m40)	374.85	20909	l cum	78, 37, 739
3	Pier (m35)	2616.67	19008	l cum	497, 37, 663
4	Superstructure (m50)	2857.95	28562	l cum	816, 28, 768

**Reinforcement Concrete items**

1	Pier cap (m 40)	43.48	97383	l MT	42, 34, 213
2	Pier (m 40)	74.97	97383	l MT	73, 00, 804
3	Pier (m 35)	418.67	97383	l MT	407, 71, 341
4	Superstructure (m 50)	314.37	97383	l MT	306, 14, 294
5	Prestressing steel	157.19	207859	l MT	326, 73, 356

**Government can provide 100% tax exemption for transportation own investing funding**

1. Government to bear the cost of project feasibility study, land for the right-of-way and wayside amenities, shifting of utilities, environment clearance, cutting of trees, etc.
2. Foreign Direct Investment up to 100% in transportation sector
3. Provision of subsidy up to 40% of project cost to make projects viable; the quantum of subsidy will be decided on a case-by-case basis
4. 100% tax exemption in any consecutive 10 out of 20 years after commissioning of the project
5. Duty free import of high capacity and modern equipment
6. Road sector has been accorded the status of an industry via Section 18 (1)(12) of the Infrastructure Act, and Easier external commercial borrowing norms



## 21- FINANCIAL VIABILITY, FARE STRUCTURE AND FINANCING OPTIONS

### **Introduction**

The Double Decker Maglev Magnetic Mono Rail covering a route length of 42.000 m is proposed to be constructed from 2017 to July-2019. The fixed cost at March-2016 prices is estimated to be of Rs.3246 Crores including the cost of land but excluding taxes and duties. The estimated cost including Central taxes and duties is Rs.3924 Crores.

### **Costs**

#### **Investment Cost**

For the purpose of calculating the Financial Internal Rate of Return (FIRR), the completion cost with central taxes of Rs.3924 Crores has been taken as the initial investment.

- The construction is expected to be completed by Dec-2019, and accordingly the cash flow has been worked out.
- The land cost is divided into three initial years during which it is expected that the land acquisition work would be over and related payments would have to be released.
- The escalation factor used is 5% p.a.

#### **Additional Investment**

The above table depicts the change in the growing population in the years to come will definitely pave way for the increase in the rail cars. The new rail cars will be bought by the revenue generated by the MTC TRANS system itself. The frequency between two rail cars will be 6 minutes. When the time duration is reduced to 3 minutes, additional rail cars will be bought. The cost of per rail car is 8 crores. Depending upon the population, the remaining new cars will be purchased.

#### **Operation & Maintenance Costs**

The Operation & Maintenance costs can be divided into three major parts:

- Staff costs.
- Maintenance cost which include expenditure towards upkeep and maintenance of the system and consumables.
- Energy costs.

The staffs are assumed to be provided @ 10 persons per kilometer. The escalation factor used for staff costs is 9% per annum to provide for both escalation and growth in salaries. The cost of other expenses is based on the O&M unit cost expected for the Delhi Metro project.



The rate of electricity assumed is about Rs. 4.00 per unit and the same has been used for all calculations. The O&M cost (excluding staff cost) has been obtained by providing an escalation of 5% per annum. Although depreciation does not enter the FIRR calculation (not being a cash outflow) unless a specific depreciation reserve fund has been provided, in the present calculation, depreciation calculations are placed for purpose of record. These are taken @ 3% of the total completion cost adjusted for land cost.

**Replacement Cost**

The replacement costs are provided for meeting the cost on account of replacement of equipment due to wear and tear. With the nature of equipment proposed to be provided, it is expected that only 50% of the Signalling and Telecom and 25% of electrical works would require replacement after 20 years. Further, 50% of the Signalling and Telecom and 25% of electrical works would require replacement after 30 years. These costs have been provided duly escalated @ 5% per annum.

**Fare Box Revenue Traffic**

The projected traffic/Day is shown in the growth rate for traffic is assumed at 2.75% per annum up to 2021-22, 3.25% per annum up to 2031-32 and 3% thereafter.

Year	capcity	Hour trip	Per day hour	Per day users
2019-20	100*2=200*	12*	17*	40,800
2021-22	100*2=200*	17*	17*	57,800
2030-31	100*2=200*	24*	17*	81,600

**Trip Distribution**

The distribution has been assumed based on the average trip length of 6.22 KMs

Distance in kms.	Distribution
0-2	8.00%
2-4	23.00%
4-6	30.00%
6-9	20.00%
9-12	10.00%
12-15	4.50%
15-18	2.00%
18-21	2.00%
21-24	0.50%
<b>Total</b>	<b>100%</b>



**Fare Structure**

Presently, in **Tamil Nadu Govt Buses**, the fares are charged as per the following table

Distance In Km	Fare Rs
0-2	0-5
2-4	5-7
4-6	5-7
6-9	10-15
9-12	10-15
12-15	12-15
15-17	12-15

There is a discount of 10% on journey by Smart Cards. Tourist Cards @Rs.100 with a validity of 1 day. Tourist cards @ Rs. 250 with a validity of 3 days. This fare structure is as recommended by Govt. approved Fare Fixation Committee. In Delhi, the ordinary bus fare structure is as follows: Rs.5 for 0-5 km slabs and increase thereafter. The fare structure to be adopted for the MMDDRTS has been based on the bus fares increased by 1½ to 2 times and somewhat matching with the fares prevailing on the Delhi Metro. While fixing the fares main considerations have been to attract passengers to rail and encourage long distance passengers to use this system.

**MTC TRANS** provides a reliable, safe, comfortable and fast mode of transport with air-conditioned comfort it is expected passengers will not mind paying 1½ to 2 times of the bus fares. The fares suggested as under are considered affordable to ordinary commuters.

**Other Sources of Revenues**

Other revenues from Property Development and advertisement have been estimated at 10% of the fare box revenues during operations. In addition, Apart from development of property on metro stations and depot it is possible to raise resources through leasing of parking rights at stations, advertisement on trains and tickets, advertisements within stations and parking lots, advertisements on viaducts, columns and other metro structures, co-branding rights to corporate, film shootings and special events on metro premises.

In addition to the above, Chennai Corporation should collect surcharge on property taxes @20% and hand over to the **UNITY** Company to augment its revenues. This will fetch Rs. 3 crore per annum. A transport tax may also be levied on every employer in the city who employs more than 10 persons at a rate of 2% of their wage bill. A good public transport in the city benefits the employees substantially. This will fetch recurring revenue of Rs.5 crore per annum. Thus, total recurring incomes on these accounts have been taken @ Rs.8 crore p.a. for working out the FIRR.



**Financial Internal Rate of Return (Firr)**

The FIRR on the completion cost without Central Taxes and With Central Taxes is shown in table.

Particulars	Completion cost	Firr%
Completion cost with taxes	4079.00	17.09%
Completion cost without taxes	3316.00	19.52%

**Funding**

The 1st phase of the **MTC TRANS** Project at CHENNAI is expected to be completed in a period of 3 years. Assuming that the project could get Government’s approval and the work commence on the field by end of 2015, the completion of the project is expected by end of 2018.

Different models for financing the Project.

Possible models for financing a Mono Rail Project are –

- A Build, Operate & Transfer (BOT) model,
- A Public Private Partnership (PPP) model and

Fully through private financial Funding, i.e. unity infra transit project implementers mobilizing all the funds for the project. Possibilities of these three models of financing MTC TRANS Project are discussed below.

**BOT Model**

Under this model, a BOT concessionaire is selected through competitive bidding. The concessionaire brings in all the funds, appoints consultants for design, planning and project management, executes the project fully, then operates and maintains the system, collects all the revenues and at the end of the concession period, hands over the project to the owner viz the Government. Here the Government’s responsibility is only to make available the required lands and right of way and monitor the quality of services and safety standards. Building the system to the required safety standards and obtaining the safety certificate from the competent authority will be the responsibility of the BOT operator. Here the Government has no financial liability and all the risks are carried by the BOT operator.

**PPP Model: There Are 2 Variants Under This Model.**

**Variant (I)**

With Government funding the fixed infrastructure such as land and basic civil structures, and a private investor funding all the system such as rolling stock, Signalling, power supply, traction, track, fare collection E&M works etc including station architectural finishing.





An example for this is Delhi Metro Airport line. Under this arrangement the Government's investment will be about 40% of the cost of the Project and the PPP Operator funds the remaining 60%. Under this model the concessionaire, operates and maintains the system to the required and agreed service and safety levels. All the revenues will accrue to the Operator and at the end of the concession period the project is handed over to the owner. Ridership risks are taken by the operator or shared by the operator and owner.

**Variant (2)**

Under this the Government acquires the required land and offers to the concessionaire free of cost. The private partner funds all the rest of the project, operates and maintains the system taking all the revenues and risks. His expected losses are made good through a Viability Gap Funding (VGF), by the Government arrived at based on competitive bidding. At the end of concession period the system reverts to the owner. Under the PPP model, Sweeteners are sometime offered to the operator in the form of lands for commercial exploitation. Private management generally ensures better efficiency in the execution and operation of the system compared to a Government agency.

The debt portion of the Project can also be covered through supplier's credit. Supplier's credit generally covers the cost of all imports such as rolling stock, Signalling etc. The suppliers arrange the credits through EXIM Banks of their country and the terms offered are sometimes better than bilateral aids. Supplier's credit is a route, which can be very competitively and intelligently exploited to cover the cost of all imports and generally more advantageous than bilateral loans. Bilateral loans take a long time for negotiation and finalization whereas suppliers' credit can be finalized quickly along with tender finalization. Urban transit projects are not financially viable and have a long gestation period and therefore loans with a long tenure of 10 to 13 years are preferred. Such long tenure loans are not generally available with suppliers' credit and therefore a mechanism for recovering the loans may have to be worked out. Further the lenders will generally insist on recourse in the form of Government guarantees or escrow accounts.

**Recommended Financial mode**

The MTC TRANS Project having a FIRR of 17.09%with Taxes and 19.52% without any taxes and duties will not attract any BOT operator or a PPP player. The Viability Gap Funding for PPP operator will be 85% of the project If the government is to assist 85% of the cost of the project why then at all the Government should go for private participation? The Government can as well fund the remaining 15% cost through its own borrowing. Further, the process of selecting a BOT operator or a PPP player will take anything from 18 to 24 months. Thereafter the concessionaire will take another 12 to 18 months for financial closure, to appoint consultants, finalization designs & tenders & to start physical work – a delay of 2 to 3 years.



Any private operator will come forward with the objective of making huge profits and thus the ultimate cost of the project will be very high. Consequently, a higher fare Structure will be necessary to sustain the project. In a public transport system it is necessary to keep the fare levels to the affordable level of the common commuters. Therefore, in the case of **MTC TRANS** Project we do not recommend either a BOT or PPP route. To get the project executed in the shortest time possible and at the least cost the SPV route with Government funding is the best option.

***SPV route and project loan***

Unity Infra Transit Project Implementers the undertaken fully as a initiative and an SPV under the name “**MTC TRANS RAPID SYSTEM**” or (under any other name), may be formed fully owned by Unity Infra Transit Project Implementers.

The remaining 60% of the project cost which cover the cost of rolling stock and other systems should be funded through supplier’s credit.

The finalization of bilateral loans will take nearly 3 months. The lending agencies stipulate their own guidelines for the procurements which will delay the project by 6 months. Raising loans from the local markets can be a last resort and to the minimum extent possible as such loans are very expensive. This may be still necessary to liquidate suppliers’ credits. Further the private operator will insist on Government taking the ridership risks the estimate funding under the BOT model.

1) Both governments should extend remission of taxes and duties to the project, considering its importance for technology acquisition. If this is not possible, then taxes and duties should be reimbursed to the project in the form of subordinate debt by both the Governments.

2) If Tamil Nadu Govt. cannot impose the green tax for political reasons, then this 6% cost should also be taken to debt (i.e. Suppliers’ credit) in which case the debt portion of funding will be 42%.

In the case of Projects, the size, number of coaches and other characteristics of the rolling stock decide the moving dimensions and design of civil structures. The Signalling and traction power system also have to match with the rolling stock. Similarly the layout and equipments for the Depot as well as the design of turnouts all depend upon rolling stock. We would therefore suggest that rolling stock, traction system, Signalling and telecommunication, depot installation, turn outs, and technology support are all combined into one single package and procured through suppliers’ credit and this will cover roughly 60% cost of the project.



Basically there is only 3 suppliers for supply of rolling stock viz.

- 1 M/s. Hitachi Ltd of Japan.
2. M/s. Bombardier, Germany.
3. M/s. Siemens, Germany.

All these three suppliers are capable of bringing in supplier's credit through their respective EXIM banks or they may be even able to tie up bilateral loans from their respective countries (like JICA, JBIC or KFW) to cover the project supplies. The above funding model will ensure completion of the Project within 3 years and at the minimum cost.

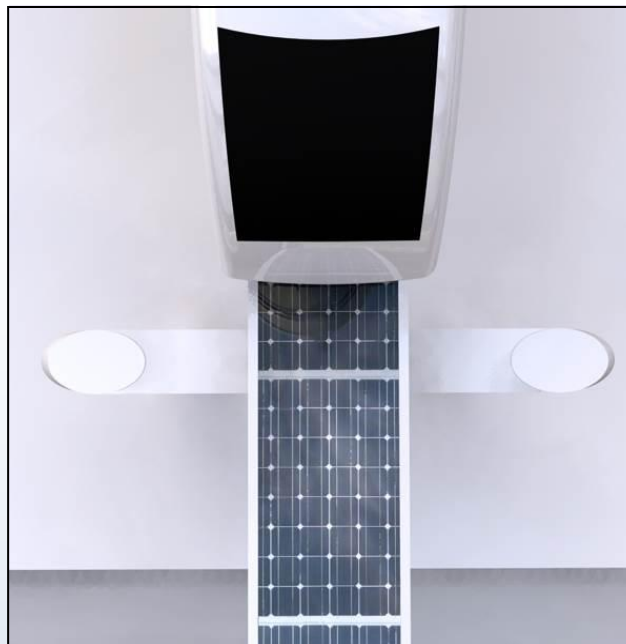

### **IAT-MAGLEV MAGNETIC DOUBLE DECKER TRANS RAPID SYSTEM WHOLE GUIDEWAY INSTALLED WITH SOLAR PANELS**

*India, like other developing countries, is facing an acute shortage of energy. The situation is more serious in case of India as the economic growth is adversely affected by this shortage of energy (both in the form of electricity and fuel). Ground transport sector consumption is one of the major loads on the energy supply of the country and the potential for solar PV transport is huge which needs to be added to other mass transit systems in the country. The ailing economy of India can no longer support the ever increasing demand for energy and the transport sector can aid in direct contribution towards the economic growth. Therefore, the proposed solution is a solar powered mass transit system (like railway) to firstly reduce the overall number of vehicles in the country, thereby reducing energy supply and demand situation and secondly improving quality of life through reduced environmental pollution. The fuel saved from transport sector, which is a huge burden on the fragile economy, can be diverted to the power generation units to provide electricity to the local industry to increase the country's GDP, job creation, economic prosperity and social uplift of the people of Tamil Nadu, India.*



## 22 - ECONOMIC APPRAISAL

### Introduction

Economic appraisal of a project starts from quantification of measurable economic benefits in economic money values, which are basically the savings of resource cost due to introduction of the MMDDRTS. Economic savings are derived from the difference of the cost of the same benefit components under 'with' and 'without' rail. Total net savings/or benefit is obtained by subtracting the economic cost of the project (incurred for construction (Capital) and maintenance (recurring) costs for the system) from the benefits out of the project in each year. The net benefit value which would be negative during initial years becomes positive as years pass. Internal rate of return and benefit cost ratio are derived from the stream.

The sources from where economic savings occur are identified first. Although there are many kinds of primary, secondary and tertiary benefits, only the quantifiable components can be taken to measure the benefits. These components are quantified by linking with the number of passengers shifted and the passenger km saved by the trips which are shifted from road/rail based modes to metro. It may be observed that first four benefit components given in are direct benefits due to shifting of trips to metro, but other benefit components are due to decongestion effect on the road. Benefit components were first estimated applying market values then were converted into respective Economic values by using separate economic factors which are also given in table. Depending upon methodology of estimation, economic factors are assumed. Overall economic value of benefit components is 88% of the market value. Similarly economic value of the cost components are 80% of the market cost

### Cost Benefit Components due to Maglev Magnetic MTC TRANS

Cost/Benefit Components	Economic factors
1 Construction Cost	60%
2 Maintenance Cost	60%
3 Annual Time Cost Saved by Metro Passengers	90%
4 Annual Fuel Cost Saved by Metro Passengers	80%
5 Annual Vehicle Operating Cost Saved saved by Metro Passengers	80%
6 Emission Saving Cost	100%
7 Accident Cost	100%
8 Annual Time Cost Saved by Road Passengers	90%

### Values adopted for some important variables

Benefit components are converted (by applying appropriate unit cost) to money values (Rs.). Derivation procedures of some of the values used for economic analysis.



	<b>Values</b>	<b>Important variables</b>
1	Rs. 1.27/min (2016)	Time Cost derived from passenger's monthly income level.
2	Market Rate (2012)	Fuel Cost (value of Petrol, Diesel and CNG).
3	Table 15.1	Vehicle Operating Cost (Derived from Life Cycle Cost of different passenger vehicles per km)
4	Table 15.2	Emission (gm/km as per CPCB and UK Norms) Emission Saving Cost (adopted for Indian conditions in Rs/ton).
5	Table 15.3	Accident Rate (No of fatal and all accidents per one Cr.KM). Accident costs are derived from published papers at current rate.
6	25.33%	Passenger km – Vehicle km conversion factor and mode share percent values (derived from fresh traffic volume count and modal split within study area) .
7	Road User Cost Study Model	Fuel Consumption of vehicles at a given speed is derived
8	Rs. 0.5/vehicle km	Infra Structure Maintenance Cost is derived from published values on annual expenditure on roads and traffic and annual vehicle km
9	17.19 min	Average Journey Time Saved after Shifting (Derived)
10	20 kmph	Present Public Transport Journey Speed (Speed & Delay Study)

Per Vehicle KM	Bus	4 Wh (Large)	4 Wh (Small)	2 Wh (MC)	2 Wh (SC)	3 Wh (Auto)	Mini Bus
Maintenance Cost	3.94	3.31	2.01	0.57	0.72	2.25	2.75
Capital Cost	2.40	2.67	1.20	0.18	0.16	0.72	1.72
Total VOC	6.98	6.58	3.54	0.82	0.96	3.27	4.92

VEHICLE	CO	HC	NOX	PM	CO	CO2
BUS	3.72	0.16	6.53	0.24	3.72	787.72
2W-2 STROKE	1.4	1.32	0.08	0.05	1.4	24.99
2W-4 STROKE	1.4	0.7	0.3	0.05	1.4	28.58
MINI BUS	2.48	0.83	8.26	0.58	2.48	358.98
4W-SMALL	1.39	0.15	0.12	0.02	1.39	139.51





4W-LARGE	0.58	0.05	0.45	0.05	0.58	156.55
TATA MAGIC	1.24	0.17	0.58	0.17	1.24	160
3W	2.45	0.75	0.12	0.08	2.45	77.89
Cost	RS. 100000 PER TON					500

**Vehicle Emission 2011-2021 (CPCB) and Cost in Rs.  
Accident Rate and Cost**

Accident Rate in the year 2016	/Cr.Vehicle KM	Cost in Rs
All Types.	1.15	294455
Fatal Accident.	0.08	846324

**Traffic parameter values used for economic analysis are given**

Particulars	2018	2023	2028	2033	2036	2043
Trips/day <b>MTC TRANS</b>	124100	136510	156986	180534	207614	238756
Line Length	17.200	17.200	17.200	17.200	17.200	17.200
Average Trip length	6.00	6.00	6.00	6.00	6.00	6.00
Passenger km	744600	819060	941919	1083206	1245687	1432541
Passenger km/km	43290	47619	54762	62977	72423	83287

**Economic Benefit Stream**

Benefits in terms of money value are estimated directly from the projected passenger km saved for the horizon years (2016, 2021, 2026, 2031 and 2041) and values for other years are interpolated on the basis of projected traffic. Market values are used for calculating costs and then appropriate economic factors are applied. For each year values of each benefit components are obtained and thus benefit stream is estimated. Benefit Components Stream for **MTC TRANS** Project Benefit components for the year 2019 are shown in figure below, which shows benefits are mainly coming from saving of travel time (65%), VOC (12%) and fuel cost (approximately 13%). Other benefits are marginal. In this area, personalized modes (car and two wheelers) are dominant which have made vehicle by passenger ratio very high (25%). Average modal split obtained from the traffic volume count survey shows that 79.35% vehicle trips are by private modes as may be seen in. Obviously presence of dependable mass transport system is not there.



**Percent of Benefits**

**IAT-MAGLEV Double Decker Maglev-Magnetic Trans Construction Cost**

Total cost of project construction (CAPITAL COST) is derived after considering cost of all major component such as Relocation and Rehabilitation(RR), Civil construction for underground and elevated portions, Stations and Depots, Track laying, Signalling and telecommunication, Power traction line, Rolling stock, Man power etc. RUCURRING COST includes energy cost, maintenance cost, and operation cost. Economic analysis period is taken from 2015-16 to 2041-42 out of which 5 years are marked as construction period. Additional capital intensive costs may occur in the years 2022-23, 2031-32 and 2038-39. Operation is expected to be started in 2018-2019.

**Estimated Capital and Recurring Cost including Central Tax**

Passenger Vehicles	% Pass	% Veh
Bus	49.56%	4.35%
Tempo	4.96%	1.09%
Car	12.33%	17.39%
Taxi	3.30%	3.26%
2 Wh	21.97%	61.96%
Auto	7.87%	11.96%
	100.00%	100.00%

**Estimated Capital and Recurring Cost Including Central Tax**

Year	Cash Flows	Expenses	Net Profit
1	13,595,085,994		
2	13,595,085,994		
3	13,595,085,994		
	<b>40,785,257,983</b>		
4	2,772,960,000	136,080,000	2,636,880,000
5	3,188,904,000	142,884,000	3,046,020,000
6	3,667,239,600	150,028,200	3,517,211,400
7	4,217,325,540	157,529,610	4,059,795,930
8	4,849,924,371	165,406,091	4,684,518,281
9	5,577,413,027	173,676,395	5,403,736,632
10	6,414,024,981	182,360,215	6,231,664,766
11	7,376,128,728	191,478,226	7,184,650,502
12	8,482,548,037	201,052,137	8,281,495,900
13	9,754,930,242	211,104,744	9,543,825,499
14	11,218,169,779	221,659,981	10,996,509,798



15	12,900,895,246	232,742,980	12,668,152,266
16	14,836,029,532	244,380,129	14,591,649,404
17	17,061,433,962	256,599,135	16,804,834,827
18	19,620,649,057	269,429,092	19,351,219,965
19	22,563,746,415	282,900,547	22,280,845,869
20	25,948,308,377	297,045,574	25,651,262,803
21	29,840,554,634	311,897,853	29,528,656,781
22	34,316,637,829	327,492,745	33,989,145,084
23	39,464,133,504	343,867,383	39,120,266,121
24	45,383,753,529	361,060,752	45,022,692,777
25	52,191,316,559	379,113,789	51,812,202,769
26	60,020,014,042	398,069,479	59,621,944,564
27	69,023,016,149	417,972,953	68,605,043,196
28	79,376,468,571	438,871,600	78,937,596,971
29	91,282,938,857	460,815,180	90,822,123,676
30	104,975,379,685	483,855,939	104,491,523,746
31	120,721,686,638	508,048,736	120,213,637,901
32	138,829,939,633	533,451,173	138,296,488,460
33	159,654,430,579	560,123,732	159,094,306,847

	<b>Cumulative</b>	<b>Before Interest</b>	<b>Interest 1.40%</b>	<b>Post Interest</b>	<b>Balance to be repaid</b>
4	2,636,880,000	(38,148,377,983)	570,993,612	2,065,886,388	(38,719,371,595)
5	5,682,900,000	(35,102,357,983)	542,071,202	2,503,948,798	(36,215,422,798)
6	9,200,111,400	(31,585,146,583)	507,015,919	3,010,195,481	(33,205,227,317)
7	13,259,907,330	(27,525,350,653)	464,873,182	3,594,922,748	(29,610,304,569)
8	17,944,425,611	(22,840,832,373)	414,544,264	4,269,974,017	(25,340,330,553)
9	23,348,162,242	(17,437,095,741)	354,764,628	5,048,972,004	(20,291,358,549)
10	29,579,827,008	(11,205,430,975)	284,079,020	5,947,585,746	(14,343,772,803)
11	36,764,477,510	(4,020,780,473)	200,812,819	6,983,837,683	(7,359,935,120)
12	45,045,973,410	4,260,715,427	103,039,092	8,178,456,808	818,521,689
13	54,589,798,909	13,804,540,926	(11,459,304)	9,555,284,802	10,373,806,491
14	65,586,308,707	24,801,050,724	(145,233,291)	11,141,743,089	21,515,549,580
15	78,254,460,973	37,469,202,989	(301,217,694)	12,969,369,960	34,484,919,540
16	92,846,110,377	52,060,852,393	(482,788,874)	15,074,438,277	49,559,357,817
17	109,650,945,204	68,865,687,220	(693,831,009)	17,498,665,837	67,058,023,654
18	129,002,165,168	88,216,907,185	-	19,351,219,965	86,409,243,618
19	151,283,011,037	110,497,753,053	-	22,280,845,869	108,690,089,487



20	176,934,273,840	136,149,015,857	-	25,651,262,803	134,341,352,291
21	206,462,930,622	165,677,672,638	-	29,528,656,781	163,870,009,072
22	240,452,075,706	199,666,817,722	-	33,989,145,084	197,859,154,156
23	279,572,341,827	238,787,083,843	-	39,120,266,121	236,979,420,277
24	324,595,034,604	283,809,776,621	-	45,022,692,777	282,002,113,054

The **MTC TRANS** MMDDRTS Project covers 42kms with 36 stations and will have a completion cost of Rs **4078** crores. Projects are generally not financially viable. CHENNAI city does not have vacant Government or Corporation lands which can be offered for commercial exploitation to augment revenues of the **MTC TRANS** system. Therefore implementing this project on a BOT basis is possible whereas a PPP model is not possible. It is therefore recommended that the project is implemented fully as a Government support initiative. By this route, the project can be completed at the shortest time and at the lowest possible cost. This is important, because then only tickets can be priced low, affordable to the common citizens and make the system truly a popular public transport. If the Government is to execute the project departmentally through existing Government departments like PWD, it would take several years with prospects of huge cost escalations. Infrastructures projects of this magnitude and complex cannot be executed by Government departments following Governmental rules, guidelines and procedures. It is therefore recommended that a Special Purpose Vehicle (SPV) with wide powers and mandates, is set up to execute the project in time and within the estimated cost. A Company under the name **“Unity Infra Transit Project Implementers” (UITPI)** or any other appropriate name should be set up and given full responsibility for implementing the project. It is therefore imperative; the SPV is headed by a mature and experienced technocrat with excellent track record and impeccable integrity. The whole success of the venture depends upon the leader chosen to head the SPV. Although UITPI will be the owner or client, the actual execution of the project will be done on a turn-key basis and on deposit term by an empowered agency as explained under. Therefore, the SPV should be a very **LEAN BUT EFFECTIVE** organization mainly functioning as a single window for Land acquisition, getting clearances from various agencies, mobilizing and releasing funds to the executing agency as and when required, monitor the progress and, in short, act as the owner of the project. The total number of staff of the SPV should not exceed 6 or 8 during construction phase mainly to reduce cost to the project

**Implementation Strategy**

The **MTC TRANS** has to be implemented through very narrow and congested streets. Barring the sole example of Mumbai monorail, the country has no precedence, experience and expertise in planning, designing and executing monorail projects.



Tamil Nadu Government or the SPV (UITPI) has two options to execute the project by engaging international **IAT-MAGLEV** for design, drawing up specifications, preparation of tender documents, finalization of contracts and project management will cost about 4 to 5% of the project cost. If **IAT-MAGLEV** is engaged, still the SPV (Special Purpose Vehicle) will require a huge organization to oversee **IAT-MAGLEV** work. The establishment cost of the SPV will also be about 4 to 6% of the project cost. Thus 8 to 11% of the project cost will be spent on General Charges alone. Worse still, the SPV will not be able to build up its technical team, since such competent and experienced persons with Railway background are not just available in the country. To reduce the cost and get the project implemented in the shortest time, we would recommend the second option viz. Handing over the project on a turn-key basis and on deposit terms to an organization, which has the capacity, resources and technical competence to handle a complex project of this type.

**Implementation sequence**

Rolling stock is the back-bone of a Double Decker Maglev-magnetic System. Rolling stock determines the moving dimensions, load, longitudinal and lateral forces, length of trains and therefore platform lengths. The Signalling, telecommunication, and traction systems, size of the concrete & tracks magnetic tracks turnouts, depot layout and planning, all depend upon and must integrate well within the rolling stock. There are basically only three manufacturers of rolling stock and each have their own distinct designs and characteristics not only in regard to Coach Dimensions but also with regard to associated sub systems mentioned above. Any change from their existing designs will cost a lot more. We would therefore recommend, without laying down exact dimensions and specifications, Rolling stock and connected sub systems like Signalling & telecommunication, traction, depot equipments, turnouts etc are all combined into one single contract package and the rolling stock supplier selected first. The rolling stock supplier will also be the technology partner and will have the responsibility for technology integration and make the total system safe and reliable. This is the first contract, therefore to be finalized. This process will take about 8 months. Meanwhile, Land acquisition work can be progressed and most of the lands taken over.

Civil Contractor for viaduct and stations can be finalized and foundation and substructure work can also be progressed but fine-tuning of the track-beams can be done only after technology partner is in position. Contracts for Power supply, power distribution, automatic fare collection, architectural works etc can also be finalized in the meantime. By the time the first train set is received, minimum facilities at the car depot have to be ready.



The stretch from the state entrance OMR Road Poonjeri Village To Thiruvanmiyur Peryier Nager , is very narrow and the road does not have sufficient width to accommodate Maglev Magnetic Double Decker **MTC TRANS** pillars along the centre. State Government has taken a decision to widen this road by acquiring land which is already frozen by the City Planning Department. Acquisition of land widening will take considerable time as a large number of people have to be rehabilitated. This will therefore be a most critical length for completion of civil works. A plan of action, backed by a detailed project report, for completing the civil works on this stretch within a time frame of 36 months has to be finalized before the project is taken up.

### **Implementation period**

Based on the approach indicated in above, requirements of rolling stock, Signalling, telecommunication, traction, car depot and turn outs should all be clubbed into a single contract package and invite global tenders should be invited. Bringing in funds either through suppliers' credit or through bilateral loans will also be a part of this tender package. The successful tenderer will be selected based on technological superiority and based on the most competitive financing arrangements. An appropriate weight age formula for these two items i.e., technological superiority and best financing terms on NPV basis, all in a very transparent and easy understandable basis should be worked out. The successful bidder then becomes the technological partner and will have the responsibility to integrate all systems. It is expected, the technological partner can be identified and selected within a period of 8 months. The schedule for completion of the project will then be as under Legal and Institutional Cover for **UITPI**

**MTC TRANS** is a new system of guided urban transport from Indian perspective and it is important that the issues related to its Legal and Institutional cover are addressed at the initial stage of project conceptualization. There is no mono-rail system operational yet in the country and one system which is in advanced stage of construction at Mumbai is being developed under Tramways Act, which we feel is not technically correct as a Maglev is no way akin to a Tramway. Developing a robust legal and institutional cover for Mono Rail is important from the key perspective because many medium and million plus cities of the country will be adopting this system particularly in the corridors where Metro Rail is not justified or technically not feasible.

The subject of appropriate Legal and Institutional cover for at Chennai has been examined and we are of the following opinion:- Double Decker Maglev-Magnetic magnetic cannot be brought under the category of Railways or Tramway. Therefore, neither the Indian Railway Act 1998 nor Tramway Act is applicable for a light rail transportation system. However, this is a rail-guided system mentioned in Clause 2((1) (i) of the Delhi Metro Railway (operations & Maintenance) Act, 2002. We therefore recommend that

- Construction of Mono Rail should be done under The Metro Rail (Construction) Act, 1978.





- Operations and Maintenance of Mono Rail should be done under The Delhi Metro Railway (Operations and Maintenance) Act, 2002.

However to ensure that the above Legal and Institutional cover are applied in a practical and correct manner following changes will be required to be made in the above Acts: a. In the definition of Metro-railway under Clause 2(1) (i) of the O&M Act as amended in 2009, the word “rail guided” should be replaced by “guided”. Such a change is necessary on account of the fact that Mono-Rail, though guidway in nature, runs on steel guidway rail.

In the definition Central Government 2(1) (a) which specifies that in relationship to Technical Planning and Safety of Railways it will mean Ministry of the Government of India which deals with Railways, certain changes are needed. The changes are required owing to the fact that Mono Rail is a new system about which Railway Ministry does not have necessary knowledge or expertise. Therefore till the country builds a few rail and operates them we have to depend on International reputed technical expertise for laying down technical parameters and also for safety certification. Therefore overall technical planning and safety shall vest with Indian Railways it should discharge its responsibility only based on recommendations of International reputed technical expertise of rail.

Similarly the safety shall be the direct responsibility of Commissioner Metro Rail Safety (and not Ministry of Railways). The necessary changes in O&M Act will be required to reflect that Chief Commissioner of Rail Safety shall discharge his functions independently and on discharging such functions it shall depend on the expert advice of the Reputed International Mono Rail Safety and Technical Experts The above changes with regard to safety responsibility shall be made in definition 2(1) (a) of O&M Act as well as Chapter IV Commissioner of Railway Safety (a new Sub-clause (e) to this effect in Clause 8 and in Chapter V Opening of Metro Railway (a new sub-clause in Clause 15 or a new clause al-together for Mono Rail).

To sum up, this is yet early days for development of innovative urban transport solution of Mono Rail in the country. It is an absolute must that the cities of the country have best technical advice and safety solutions available at par with best international practices and as such it is considered essential that both technical planning as well as safety receives the expertise of best International Technical and Safety Experts having robust knowledge of Mono Rail Systems. As such while the legal and institutional for development and O&M of Mono Rail shall be as described above, the same shall be in consonance with the necessary suggested amendments in the above Acts.



### **Operation & Maintenance**

If the MTC TRANS Double Decker Maglev Project is to be a success it is essential to ensure that the capital cost is kept to the minimum, the operation & maintenance costs are also kept to the minimum and non-operational revenues are increased to the maximum. The operation and maintenance can be handled either directly by the SPV or out sourced.

There are no Indian agencies who are experienced in operating and maintaining a Mono rail system. Therefore if the operation and maintenance is outsourced foreign companies will have to be involved which will considerably increase the operation and maintenance costs. We would therefore recommend that the SPV directly takes over the full responsibility for operation & maintenance of the system.

### **Operation & Maintenance**

If the operation & maintenance of the system is undertaken by the SPV, the total manpower requirement will be approximately 350 at the rate of 25 persons for route kilometer. In addition, the cleaning of stations and cleaning of train sets have to be outsourced. The O & M set up and organizational strength for each activity can be finalized in due course after the technology partner is in position.

### **Security**

A Public transit system, particularly rail based or guided, running on elevated structures is highly vulnerable to sabotage or other terrorists activities. The MTC TRANS System should therefore have a fool-proof security system to ensure the safety of passengers and safety of the installations. The security of the Delhi Metro System is handed over to the Central Industrial Security Forces (CISF). The State Police is responsible for the security of the Bangalore Metro system. To enable the State Government to have full control on the security of MTC TRANS Rapid System, we would recommend that security is handed over to the State Police which should deploy sufficient personnel at stations and vital installations. The strength and set up of such security system should be worked out by the State Government in due course.

### **Conclusion**

Rapid increase in traffic volume in transport systems plus the need for improving passenger comfort have highlighted the subject of developing new transport systems. The recent required increases in the traffic volume in transport systems, as well as a need for the improvement of passengers' comfort, and required reductions in track life cycle costs, have caused the subject of the development of a new transportation system. One of the important systems which have attracted industries is MMDDRTS transport system. In this regard, MMDDRTS transport system turns out to be a proper choice for transportation industries around the world. MMDDRTS systems have been recently developed in response to the need for rapid transit systems. The



MMDDRTS system comes off clearly better and surpasses the conventional railway systems in almost most fields. These include the pollution, noise emission, vibration level, environmental issues, land occupations, loading, speed, acceleration and deceleration, braking, maintenance costs, passenger comfort, safety, travel time, etc. With the MMDDRTS guideway it is also possible to reach to the minimal radiuses for the horizontal and vertical curves. A MMDDRTS vehicle can as well travel at the steeper gradients compared with the conventional rail systems.

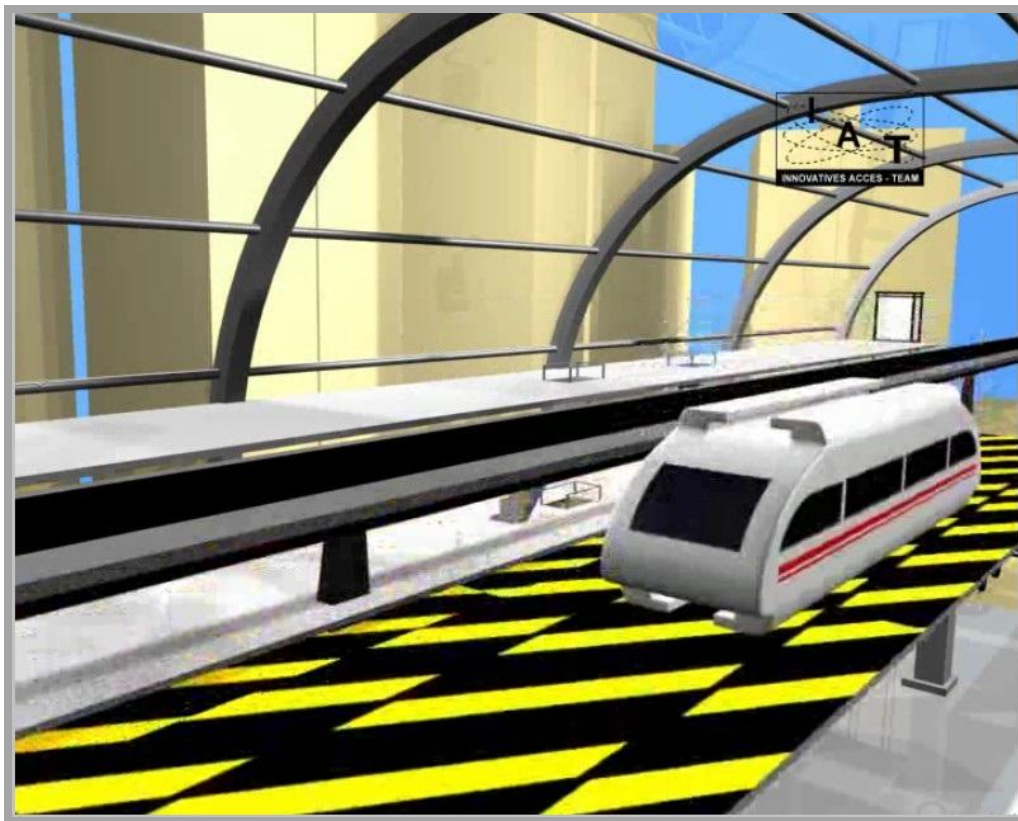

***IAT- Maglev Magnetic Double Decker Transrapid System Down To Upper Track Support of Lift***





AT 222224

68  
1-3-16

M.DHOULAT SAH

**B. Santhi**  
M. B. SANTHI, M.A. B.Sc  
STAMP VENDOR,  
122/1, Singanna Street,  
Chintadripet, Chennai-600092  
License No. 11/7 dt. 20x97  
Phone No: 8548777  
8528548

**MOU IAT MAGLEV - UNITY INFRA TRANSIT PROJECT IMPLEMENTERS**  
INDEX 29.02.2016

IAT MAGLEV  
And  
UNITY INFRA TRANSIT PROJECT IMPLEMENTERS

We wish you to act as Advisory Management Consultant with expertise in infrastructure planning and undertaking the proposed Maglev project in India. Your social science, national economy and project development expertise will win over proposals that we are putting forward to many state governments and the central government of India. Initially and presently we seek association with you for presentation to the Tamil Nadu Governments infrastructure development remit. We have chosen Tamil Nadu as because it is a independent state and decision makers Chief Secretary and the Chief Minister who both are very highly progress in Tamil Nadu

Your specialist knowledge in mass transit innovation firm with track record in identifying, piloting and deploying emerging Maglev rail systems in Germany would be a real benefit to countries like India. We undertake to maintain full confidentiality and non-disclosure principles with your resources and establishments.

**P. KARUPPIAH, M.A., B.L.,**  
ADVOCATE & NOTARY PUBLIC  
GOVT. OF INDIA  
76, AVVAI NAGAR, CHENNAI-50.

11/3/16



## Unity Infra Transit Project Implementers

38, Ibrahim Sahib Street Chennai-600001, Tamilnadu, India

044-25272030, 9025035771, 9840013753

ceo.cwbs@gmail.com, dhoulatsah@gmail.com, pssrts@gmail.com

Further we think that we would be able better protect your IP as a resident company in India. Someone somehow may copy your Maglev System sooner and latter. We look forward to a further collaboration with your esteemed company.

UNITY INFRA TRANSIT PROJECT IMPLEMENTERS (Process Pvt Limited) proposed to Tamil Nadu Government to build a Maglev Magnetic Double Decker Monorail Metro-Style Elevated Rail system using existing competitive enhanced automated rail vehicles with the financial support of turnkey service implementation IAT innovations will provide a royalty perpetual license of its proprietary technology to Unity Infra Transit Project Implementers for such equity rights. All assets, infrastructure, marketing agreements, leases and easements will remain the property.

Maglev Magnetic Double Decker Monorail decreasing energy consumption through the use of new techniques that increase portal to portal speeds that allow improved service with less vehicles that are interchangeable to carry standard containers or a new high capacity public passenger capability that allows shorter elevated service platforms for the same amount of passengers lines of new transit as a transportation mode which has an automatic system with independent routes

Maglev Magnetic Double Decker Monorail based entity focused on zero-emission, self sustaining operations, with core competencies in urban planning, passenger transportation, and smart growth. With the support of world-class strategic partners, IAT has the potential to spawn a new, global high-tech industry with compelling appeal from both a financial and environmental perspective.

Date: 29<sup>th</sup> of February 2016



Malta Headquarter

Anabel, Triq George Zahra, Luqa, Tel: 356 2527

Coral Microfinancing Holding Ltd

*[Handwritten Signature]*  
1/3/2016

**P. KARUPPIAH, M.A.,B.L.,**  
ADVOCATE & NOTARY PUBLIC  
GOVT OF INDIA  
70, AVVAI NACAR, CHENNAI-50.





## 23 - ENVIRONMENTAL IMPACT ASSESSMENT

### Introduction

With rapid economic development, particularly in urban areas, the need for rationalizing and upgrading the transport system is imperative. The travel demand of people has been increasing tremendously. This calls for planning for mass transport system which provides the city with a fast, reliable, convenient, efficient, modern and economical mode of public transport and would reduce vehicular traffic on the roads.

The increase in population in the Chennai Metropolitan Area is particularly notable. In the future, it is expected that in line with progress in urban development in the southern part of Chennai City, the population will expand in the southern area. Therefore, resolving traffic congestion especially along the IT corridor has become a problem. Project **MTC TRANS**, which is a target of this study, is located in OMR to Thiruvamiyur of the state of Chennai Tamil Nadu.

### Transport

The city has a reasonably well-developed transport infrastructure. A large number of buses, predominantly run by individual owners, ply on the major routes within the city and to nearby locations. The city has three bus stands.

### Regulatory Framework

**Environmental Framework:** Various environmental standards, specifications and guidelines of Central Pollution Control Board (CPCB) and state level agencies will also be applicable. The Government of India's EIA Notification of 2006 (replacing the EIA Notification of 1994) attracts new/expansion or modernization of any activity falling within the eight specified categories of developmental and industrial activities undertaken in any part of India. Neither railways projects nor urban transport projects are part of specified eight activities. The proposed Double Decker MMDDRTS System project will not attract this notification and therefore environment clearance including conducting of EIA study or carrying out public hearing is not mandatory.

The proposed alignment runs parallel to the seacoast at an aerial distance of about 1.5 km. locations such as crossing may be significant during construction. Since the alignment is away from sea shore it may not require Coastal Regulation Zone (CRZ) Clearance from MoEF.

**Social Framework:** The Land Acquisition (LA) and Resettlement & Rehabilitation (R&R) of the proposed project would be governed by two Central legislations: (i) Land Acquisition Act, 1894 (amended in 1984), which is an enabling legislation for land acquisition, and (ii) the National Policy on Resettlement and Rehabilitation for Project Affected Families, 2007 (NPRRP). Recently, Govt. Of has issued Resettlement and Rehabilitation Guidelines vide.





### **Alternate Alignment Analysis**

Three alternative alignments were studied to establish the final Double Decker MDDRTS System covering Main Station, Poonjeri Entrance, Paynoor, Karunguzhipallam, Paynoor Road, Omega City, Thandalam-1, Thandalam-2, Thandalam-3, Kakiyamma Kovil St, Thandalam Road, Esser Bunk stop, Thirupour Temple, Kanagapattu, Ssn Colage, Senganmal, Ramalingapuram, Madha Kovil St, Padur Road, Padur Angalamman Kovil, Kannathur Reddy Kuppam, Kazhipathur, Mettu St Eagttur Bus Stop, Navallur Main Road, Semmancheri, Thiruvalluvar Salai, Kazhipattur, Model School Road, Karapakkam, Okkiyam Thuraipakkam, Gangai Amman Kovil St, Sakthi Nagar Main Road, New India Colony Perungudi, Senthil Nagar Thuraipakkam, Ramalinga nagar Periyar Nagar. This alignment makes use of the existing traffic corridor and connects to major traffic hubs of the city. Station locations have been recommended based on existing dispersal facility (existing bus stops) in order to facilitate intermodal transfers and convenience of commuters, and also availability of the required right-of-way for stations. There are 36 stations suggested. The maximum distance is 1.2Km between the stations and the average distance is 0.90 km. Service depot is near Mahabalipuram near Poonjeri Town Entrance.

### **Proposed Depot Location**

Depot will have the provisions for heavy maintenance, overhaul capability and sub-station will be provided. The depot will cater to store trains, clean them and provide inspection and light maintenance capability. The depot will also house administrative and operational offices as well as facilities for the maintenance of the track, structures and systems along the guideways.

### **Environmental Baseline Data**

The compilation of environmental baseline data is essential to assess the impact on environment due to the project activities. Majority of data on water quality, soil, vegetation, air and noise quality was collected during field studies in April 2015.

### **Water Resources and Quality**

Chennai receives its water supply from surface flow and groundwater. The water is available from surface water source and municipal supplies for domestic use after primary treatment of adding bleaching powder. Although the river is perennial and water is available throughout the year, the supply to the public is not adequate and people have supplemented it by open wells and hand pumps. Four samples have been taken and analyses for essential parameters for drinking water quality.



### Study Area

Perungudi is situated about 20 kilometres from the heart of the Chennai city and 4 kilometres away from the coast (Figure 1). It is surrounded by the old Mahabalipuram Road and the Perungudi lake. The neighbouring areas include Kandhan Chavadi to the north, Thoraipakkam to the south and Palavakkam the east side. The natural landscapes such as Perungudi Lake and Pallikaranai marsh land are situated on the western part. The study area is elevated 9m from the mean sea level and the population in and around is highly increasing each year. It is roughly said that there was population around 2000 before two decades, and now it is estimated around more the 50000 residents live in it. Data and Methods:

### Insitu Data

The water samples were collected from fifteen different open and tube wells in the summer of 2012. During sampling care was taken as told in the standard procedures of measurement (APHA 1994). Ten parameters such as pH, electrical conductivity, turbidity, total hardness, total dissolved solids, dissolved oxygen, total alkalinity, sodium, chlorides and iron were analyzed to find the water quality index.

Determination of Water Quality Index:

Water Quality Index (WQI) is a most efficient method for assessing the quality of water. Water Quality Index (WQI) is a tool for communicating the information on overall quality of water and rates the quality of each sample locations. It acts as the perfect indicator of the quality of the water. It was first proposed by Horton (1965) to determine the suitability of the groundwater for drinking purposes. Analyzed groundwater sample data are tabulated in Table I. WQI is computed adopting the following formula.

$$WQI = \frac{\sum_{i=1}^n W_i q_i}{\sum_{i=1}^n W_i}$$

Where, W is the unit weightage factor computed using the following equation,  $n \sum W_i = K / S$  and K is the proportionality constant derived from,

$$K = \left[ \frac{1}{\sum_{i=1}^n \left( \frac{1}{S_i} \right)} \right]$$

where  $n S$  and  $i S$  are the Bureau of Indian Standard values of the water quality parameter (Table 2). Quality rating is calculated using the formula,



$$q_{ni} = \left[ \frac{(V_{actual} - V_{ideal})}{(V_{standard} - V_{ideal})} \right] \times 100$$

Where,  $ni q$  is the quality rating of  $i$ th parameter for a total of  $n$  number of water quality parameters. *Actual V* is the value of the water quality parameter obtained from laboratory analysis. *ideal V* is the value of the water quality parameter can be obtained from the standard tables. *ideal V* for pH is 7, and Dissolved Oxygen is 14.6 mg/lit and for other parameters it is equivalent to zero. *s dard V tan* is the BIS standard of the water quality parameter. Based on the WQI values, the water quality is rated as excellent, good, poor, very poor, and unfit for human consumption

### Spatial distribution of the water quality parameters

Spatial distribution is a graphical display that summarizes the data in two or more axes that is used to draw many conclusions. Spatial distribution of water quality parameters is a model representation of the water quality parameters distributed in the study area. The spatial distribution is done here by the Geographical Information system (GIS) software Arc GIS 9.3.

The GIS is the sophisticated tool to describe the spatial analysis of the distribution of the water quality on the two or more axes. Inverse Distance Weighting (IDW) is used in the spatial analysis of the groundwater. IDW is a type of deterministic method for multivariate interpolation with a known scattered set of points. The assigned values to unknown points are calculated with a weighted average of the values available at the known points.

### Results

The study area has pH as low as 6.6 and high up to 8.8. Stations 1 & 2 are spotted with high pH and station 15 has low pH (Figure 2). Station 3 to station 11 has more alkaline pH greater than 8 mainly at the verge of fit for drinking. Stations 12, 13 and 14 fall under the range of normal pH. It is also noted that pH alone cannot be the ultimate factor which is fit for drinking but also many other parameters contributes to it to state whether the water is fit or not. Stations 11 to 15 are under low conductivity range and stations 1 to 6 has high conductivity even exceeding more than 2500 micro-mhos/cm. Stations 7 to 10 having moderate conductivity varying between 1500 to 2150 micro-mhos/cm. The east zone of the study area is comparatively good when compared with the west zone

Turbidity varies from as low as 0.1 to the maximum of 12.3 NTU. The stations 13 to 14 have very low turbidity and stations 1 to 6 have high turbidity. Stations 7 to 12 are spotted with moderate turbidity varying within 3 to 9.7 NTU (Figure 4).



Station 1 has the highest amount of hardness as 750 and the station 15 has the lowest of 150 mg/l. Stations 2 to 14 are in moderate range of 630, 610, 600, 600, 550, 470, 400, 385, 385, 330, 160, 215 and 160 mg/l respectively TDS varying within the range of 100 to 750 mg/l. Stations 13 to 15 are within the range of 100 and 150 mg/l. Station 1 has the high TDS content of 750mg/l and stations 2 to 12 are decreasing as 600, 550, 450, 400, 350, 350, 300, 300, 250, 200 and 200 mg/l respectively (Figure 6). Stations 1 to 5 have very low dissolved oxygen ranging 10.5, 11.5, 12.5, 14 and 15 whereas stations 11 to 15 have high as 51, 56, 57.5, 62 and 77.5 mg/l. Stations 6 to 10 have 17.5, 18, 20, 27.5 and 27.5 mg/l respectively

Alkalinity of the study area varies from 50 to 390 mg/l whereas the stations 1 to 5 are found to have high alkaline nature and stations 13 to 15 have very low alkaline. Rest of the stations is moderate and ranges between 300 to 350 mg/l (Figure 8). Sodium in the study area is found to be higher than the permissible limit (>100 mg/l). Stations 13 to 15 have normal sodium range and the other stations vary from 200 to 370 mg/l (Figure 9). Similarly chlorides also have high values and are greater than the permissible limit (250 mg/l). Stations 12 to 15 are normal and the other stations vary from 800 to 1029.5 mg/l (Figure 10). Thus the level of the high sodium and chlorides portrays that the sea water has been intruded in this region. Iron content in this region is very low and all the stations come under the bar limit of 0.3 mg/l (Figure 11). The water quality index of the study area varies from 25 to 45. This range falls under the category of good (Table 3). The station 15 has the highest WQI and very close to the poorer range the study area groundwater is capable for the human consumption.

Location	RSPM ( $\mu\text{g}/\text{m}^3$ )	SO <sub>2</sub> ( $\mu\text{g}/\text{m}^3$ )	Nox ( $\mu\text{g}/\text{m}^3$ )	HC (ppm)	CO ( $\mu\text{g}/\text{m}^3$ )
<b>Near Addyar Bus Stand</b>					
1 <sup>st</sup> 8 hourly	45	3	5	<0.01	348
2 <sup>nd</sup> 8 hourly	46	3.5	5	<0.01	298
3 <sup>rd</sup> 8 hourly	43.5	3	4.5	<0.01	287

**Trees**

Tree survey was carried out along the proposed alignment. No forest area exists along the alignment. Most of the trees are along the proposed depot area and some are along either at the centre of the roads or on roadsides at locations of proposed stations. In case where the alignment passes through the green area tree count has been done by quadrature method. The main species are Coconut etc. No rare or endangered species of trees have been noticed during field studies.



### **Air Quality**

As a part of this study ambient air quality monitoring (AAQM) has been carried out by setting up ambient air quality monitoring stations at four locations for six parameters viz. RSPM, CO, HC, SO<sub>2</sub>, and NO<sub>x</sub>. The results so obtained are reported in the below table. The ambient air quality data indicates that all the parameters are within the permissible limits established by CPCB at all the monitoring stations.

### **Geological conditions**

Most of the soil consists of medium to low plasticity clay (CI, CL). The thickness is reported to be between 3m-6m. Soil samples that were collected indicated swelling properties.

### **Wastewater situation**

There is a drainage path running south to north along the proposed location. This drainage path crosses OMR and ends up joining the Buckingham Canal. Rainwater from heavy rains in this area run into existing wells and therefore has to flow into this drainage path. The study did not find routes taken by pollution substances.

### **Situation of ground water**

The groundwater table has been confirmed to be (an average of) 1.5m below the EGL. It has a tendency to fluctuate according to seasons. In the case of potable water, if hydrosulfate content exceeds the permissible amount, there are potential health hazards. According to BIS, recommended value (limit) of hydrosulphate in potable water is 150 mg/l, with the maximum allowable value at 400 mg/l. In 25% of the samples, nitrate concentrations in excess of 45 mg/l were detected. In addition, with regard to the total hardness of CaCO<sub>3</sub>, values exceeding 7% of the permissible level were detected.

### **Water supply**

The residents living near Project MTC TRANS proposed location use wells as their source of water for drinking and other needs. According to topographical studies, near the proposed location are 106 functional wells and watering holes for livestock.

### **Wastewater treatment**

Existing domestic wastewater treatment systems basically use septic tanks. However, there are cases in which wastewater is simply released into rivers.





**Physico-Chemical Parameters of Groundwater Samples**

Water Quality Parameters	Pre-monsoon		Post-monsoon		BIS standard Desirable	Samples exceeding desirable limit	
	Range	Mean	Range	Mean		Pre-monsoon	Post-monsoon
pH	6.3 - 8.1	7.2	6.7 - 7.9	7.3	6.5	15	Nil
Total Dissolved Solids	256 – 3584	1120	218 - 3373	867	500	1, 2, 4, 5, 6, 8, 10, 11, 12, 13, 14, 15, 16, 17, 18, 19, 20, 21	1, 5, 6, 10, 11, 12, 13, 14, 15, 16, 19, 21
Total Hardness	58.9 - 645.1	270	42.3 - 500.3	167.6	300	1, 2, 10, 13, 15, 16, 19	5, 13, 19
Calcium	17 – 158	67.5	13 - 84	37.6	75	1, 2, 6, 10, 15, 16	13, 19
Magnesium	4 – 61	24.7	2.4 - 70.8	17.9	30	1, 2, 10, 13, 15, 16, 19	5, 13
Sodium	36 – 2305	316	9.6 - 2045.2	273.3	200	1, 2, 5, 6, 10, 13, 15, 19, 21	5, 6, 13, 14, 15, 19, 21
Potassium	1 – 39	10.9	0 - 36	6.8	-	-	-
Chloride	36.3 - 1098.3	315	8.86 - 1248.4	208.4	250	1, 2, 5, 6, 10, 14, 15, 18, 19, 21	5, 6, 14, 15, 19, 21
Bicarbonate	27.6 – 788	276	12.2 - 982.1	241.1	300	1, 5, 8, 10, 13, 14, 15, 19	5, 10, 12, 19
Nitrate	0.6 - 34.7	13.6	0.38 - 32.6	11.6	45	Nil	Nil
Sulphate	35 - 341.7	111	29.1 - 379.5	122.5	200	12, 13, 19, 21	5, 13

**Soil Quality**

Most of the soil consists of medium to low plasticity clay (CI, CL). The thickness is reportedly 3m-6m.

Soil Characteristics of the Plan's Proposed Location:

According to the “Environmental Baseline Study (EBS)2” prepared by Global Marine Infra-Tech Pvt Ltd. For Tata Consulting engineers limited, which were commissioned for the task by Ascendas, the geological strata are generally comprised of the four following strata.



### **Horizon 1: Surface Stratum**

The surface stratum is comprised of medium to low plasticity clay. The thickness is reported to be between 3m-6m. Soil samples that were collected indicated swelling properties.

### **Horizon 2: Medium Density to High Density Sand (SM)**

This surface is comprised of silt, small quantities of clay, and gravel. The surface layer is comprised in the following manner. The stratum has been confirmed to be a depth of 3m-9m. This layer is comprised of bedrock matter and soil. According to Standard Penetration Tests (SPT), clay of cohesive soil is classified as rigid to very rigid. The main granules of the soil that comprises the land is medium to high density.

### **Horizon 3: Completely Weathered Rock**

Rock that is completely weathered has been confirmed to be below sand that is medium to high density. This stratum is comprised of material derived from a complete fragmentation of bedrock matter, but a portion of it maintains the mass structure of the original bedrock.

### **Horizon 4: Extremely to Considerably Weathered Rock**

Bedrock that is extremely to considerably weathered has been confirmed to be below the completely weathered bedrock. The stratum's Rock Quality Designation (RQD) has been confirmed to be between 10%-75%.

### **Drainage Situation**

There is a drainage path running south to north along the proposed location. This drainage path crosses OMR and ends up joining the Buckingham Canal. The average depth is 2.5m. The drainage path is located at the mouth of a water area approximately 1km from the proposed location. Rainwater from heavy rains in this area run into existing wells and therefore has to flow into this drainage path. The study did not find routes taken by pollution substances.

### **The Situation of Groundwater**

The groundwater table has been confirmed to be (an average of) 1.5m below the EGL. It has a tendency to fluctuate according to seasons. In order to inspect the suitability for potable water, a study was conducted by collecting (10) water samples from wells. Parameters for substances confirmed in the field included EC, PH, and ORP. In addition, the following were detected: iron, lithium, sodium, NH<sub>4</sub>, potassium, calcium, magnesium, dissolved salt, sodium, total hardness, bicarbonate, hydrosulphate, ferrous substance, acetate, chloride, nitrites, sodium ammonium phosphate, silica (silicon dioxide), phenol (carbolic acid), and insecticide. The parameters for the above-mentioned list applied standard techniques stipulated by APHA.



In general, the groundwater of the aquifer near the surface is colourless and odourless. It indicated slightly alkaline properties. The electrical conductivity of the groundwater in the area studied was 425~2,383 $\mu$ S/cm.

The groundwater of areas with a conductivity exceeding 2,383 $\mu$ S/cm, which is not suited for use around the house or potable water, was confirmed to be at conductivity below 425 $\mu$ S/cm. Areas with chloride levels below 800mg/l are considered by BIS to be the limit for potable water.

If potable water contains hydrosulphates, there is a possibility that exceeding the acceptable amount will present health hazards. BIS considers 150mg/l to be the (limit of the) ideal amount of hydrosulphate to be included in potable water. The maximum acceptable limit is 400mg/l. Other than water that includes total hardness and nitrate salt, all of the substances, to a certain degree, are considered to be suited for potable water and for use around the house.

While an excessive amount of nitrate salt, 45mg/l, was detected from 25% of the samples, a figure exceeding the acceptable amount by 7% was detected when it came to the total hardness of CaCO<sub>3</sub>. This case of high levels of total hardness is unique to the aquifer of this area and is thought to be a result of litho unit's compounds. Furthermore, the contamination by nitrous acid is said to be a result of insecticides and fertilizers used agriculturally. As for the suitability of irrigation based on specific conductivity levels and the Sodium Absorption Ratio (SAR), the groundwater of the aquifer near the surface is considered to cause high to extremely high levels of chloride damage and alkaline damage.

The area of the proposed location uses agricultural phenol (carbolic acid), but what was detected was a density below the BDL (Below the Detectable Level). Insecticides were detected at a level below the level possible to be detected. Climate

In order to analyze the climate of the proposed location, climatologically data from the area surrounding Nungambakkam IMD station (1951-1980) was obtained. The following table was prepared based on the results from observing the area surrounding Nungambakkam IMD station and shows data concerning strongest wind directions and wind speeds.

Most of the land is used for agricultural purposes. During the study, no surplus soil (remnants of mounds) or illegal disposal was observed. Moreover, no solid waste was seen. A small amount of solid waste is generated during the processing of the existing garbage from farms.

### ***Environmental changes expected to accompany this project***

#### ***Environmental improvement effects***

- Improvement in living standards in areas surrounding the project site as a result of mixed-use urban development including residential, industrial, and commercial facilities
- Resolution of traffic congestion as a result of decentralization of residential areas and work places



- Easing of traffic congestion and reduction of pollution substances due to improvement of the road environment
- Use of ground water as potable water and water for household uses as a result of purification of ground water

**Environmental deterioration**

- Increase in industrial waste, wastewater, and domestic wastewater

While this project will not immediately lead to environmental deterioration, it is necessary to take appropriate steps and promote development, while taking environmental consideration measures because the project site is located near areas that have been historically preserved and used.

Major portion of the land within the region is utilized for agricultural purposes. No evidence of surplus soil (traces of mounding) or unauthorized dumping was found for the duration of the survey/study. Therefore, Omega target sites will not be subject to waste material surveys.

The potential for soil contamination arises from such actions as inadequate wastewater processing including the discharge of untreated water and open dumping of waste material. Prevention of soil contamination requires the regulation of waste processing, concurrently with the implementation of a suitable waste control/management system and infrastructure development. As soon as land appropriation is completed, suitable waste control/management system is to be installed and infrastructure development is to be undertaken.

**Wind Data**

<b>Month</b>	<b>Average Wind Speed (km/h) (annual)</b>	<b>Notable Wind Directions</b>
January	5.6	NE (33%) E (18%) N (17%)
February	5.4	E (24%) SE (16%) NE (14%)
March	6.6	SE (27%) SW (16%) S (14%)
April	8.2	SE (32%) S (28%) SE (22%)
May	10.1	SE (27%) S (23%) SW (22%)
June	10.3	W (34%) SW (21%) SE (18%)
July	8.7	W (30%) SW (29%) SE (13%)
August	8	W (33%) SW (22%) SE (15%)
September	7.2	W (25%) SW (22%) SE (17%)
October	4.9	NE (15%) W (14%) SW (11%)
November	6.3	NE (32%) N (21%) E (12%)
December	7	NE (38%) N (28%) NW (11%)



## Noise

Noise levels have been measured at five places in Chennai as per standard practice. The noise levels so obtained are summarized. The locations of Noise level monitoring sites have been shown in the following figure.

Traffic noise pollution studies of the three cities Chennai

1. MTL Thousand Lights
2. MTLN Thousand Lights Side line
3. MHIC High court
4. MCEN Central Railway Station
5. MUSR Usman Road T. Nagar
6. MANN Annasalai
7. MADY Adayar
8. MPON Pondy Bazar

Noise Measurements: Traffic noise mainly comprises of vehicular traffic sound that is emitted by heavy transport vehicles (of higher sound intensity}, lighter motor vehicles (of medium sound intensity}, taxis/cars and mini-vans (of low sound intensity), auto trishaws and two wheelers (both of fairly high sound intensity). Since the traffic noise is also proportional to the number of vehicles passing per unit time duration, the speed of the vehicle, and the condition of the vehicle. A model can be developed for each location or the traffic density (and noise) can also be statistically predicted.

All measurements associated with the sound and noises are to be standardised. As cited already, the concerned institutions stipulate international standards for measurement and control of noise IOC R.131 stipulates the subjective magnitudes of sound and noise [1] while section 3 of ISO R.140 deals with the field measurements required for traffic. The sound pressure level is expressed by ISO R.1683 ( $=20 \log (p/p_0)$ ), where  $p$  is the pressure associated with the measurement and  $p_0$  the reference pressure (20 micro bar) [1], It is necessary to express the noise levels in terms of perception characteristics of human ear. To accomplish this three-weighted networks (A, B, or C type) [1] are conventionally used. A-weighted network is preferred because its attenuation behaviour is close to that of a normal human ear.

The measurements made on using an A-weighted network are expressed in dbA. For measurement of noise emitted by vehicles ISO R.362 is recommended. This recommendation is based on a moving vehicle test using a precision sound level meter with a A-weighted network under ‘Tast response” mode. An open space of 50 m radius with an inner 20 m concrete/asphalt (or other equivalent material) platform is desirable.





The measuring instrument is placed at the centre of the platform, the microphone being located at a height of 1.2 m pointing outwards. The vehicle has to move in circular path around the 10 m central platform.

The vehicle is to be driven at a % of the maximum engine speed or 50 km/h (which ever is lower) in the second gear for a 3-gear vehicle or in the third gear for a 4-gear vehicle (geared at the last but one of the forward gears). Neither the road is circular with respect to measuring location nor the vehicles move with constant speed and hence the conditions of measurement do not comply to the ideal stipulations. Our measuring locations usually lie at height of 1/1.3 m from the ground/ pavement and at a distance of (at least) 5m away from any vehicle. Usually no intervening building or wall is present on the back side. The microphone is placed pointing vertically upwards. The vehicles are moving in both the directions if the road traffic is not restricted as one way. Since it is usually open on the roadside, the recorded sound is an integral estimate of total vehicular traffic noise, reflected noise (after absorption) from the buildings on both sides, reverberations if any and the background noise established by the surroundings. It could be concluded that the noise levels recorded are higher than prescribed permissible levels of 65-dBA (day) at all the locations however in night, noise levels are within the prescribed limit of 55-dBA (night) at all locations.

**Socio – Economic Assessment**

A socio-economic survey was undertaken for the proposed corridor to assess the socio-economic conditions of project-affected families/people and to examine the impacts of the proposed Double Decker MMDDRTS System alignment on their conditions. On the basis of alignment drawings and field survey work during April and May 2012, it is observed that there are two types of impacts on the PAFs. If there may be displacement of residential/commercial establishments due to acquisition of land etc, employees employed in the working commercial establishments all over the alignment affected due to the acquisition of the shops for the construction and operation of the Double Decker MMDDRTS System will be taken care of. The PAFs/PAPs are dependent on the properties either as land owners or as lessees/ tenants or employees of establishments. These families need to be relocated/ compensated properly.

There is a proposal to widen the road from university to ECR round turn a distance of 10 kms, under the city improvement scheme by acquiring lands to have a right of way of 24 meters for which land has been frozen for about 20 year back. The socio-economic problems arising out of this road widening has not been covered in the above assessment. This will have to be taken care of in the city improvement scheme itself.



**Type of Effects**

It is evident from the collected data; houses are not going to be affected. However shops are going to function as usual and no effect will be there on their earnings in case any shopkeepers are prone to lose their property, will be compensated at Market rates. Moreover, employees are also deriving their subsistence from the affected shops. There will be requirement of providing them alternative job opportunities as per the Resettlement and Rehabilitation guidelines of Government of Tamil Nadu.

**Negative Environmental Impacts**

The main aim of the project is to decongest the road traffic. The project is designed keeping in view population growth, future traffic demands and environmental protection aspects. Attempts have been made to quantitatively predict the impacts due to proposed project. For non-quantitative impacts, qualitative assessment has been made. Potential impacts have been considered, while recommendations for mitigating measures have

**Impacts Due To Project Location**

**Project Affected People (PAPs)**

Rehabilitation and Resettlement (R&R) of displaced families is an important issue. The main point to be addressed is the extent to which the “land for land” policy can be maintained for those who have their own land/house and suitable compensation to those who fall in the category of unauthorized occupants.

**Loss of Forests/Trees**

The proposed Double Decker MMDDRTS System line is in urban/ city area and will not pass through any forests. Hence no loss to forest is anticipated due to the project. However, planted trees do exist at places in the corridor selected for the project. There are 65 trees along the alignment Trees are major assets in purifications of urban air, which by utilizing CO<sub>2</sub> from atmosphere, release oxygen into the air. However, with removal of these trees, the process for CO<sub>2</sub> conversion will get effected and the losses are reported below:

i)	Total number of Mature Trees	:	71
ii)	Decrease in CO <sub>2</sub> absorption @ 21.8 Kg/ year/ tree for 8 years	:	1508.12 kg
iii)	Oxygen production @ 49 kg/ year tree		
	For 8 years	:	47816 kg



### **Utility/Drainage Problems**

Double Decker MMDDRTS System line is planned to run through the urban area at grade and elevated. The alignment will cross river system, and number of sub-surface, surface and utility services, viz. sewer, water mains, storm water drains, telephone cables, overhead electrical transmission lines, electric pipes, traffic signals etc. Since these affect construction and project implementation time schedule/costs for which necessary planning/ action needs to be initiated in advance.

### **Impacts Due To Project Construction**

Although environmental hazards related to construction works are mostly of temporary. Appropriate measures should be included in the work plan and budgeted for.

The most likely negative impacts related to the construction works are:

- Soil erosion, pollution and health risk at construction site.
- Traffic diversion and risk of existing building.
- Excavated soil disposal problems.
- Dust Generation.
- Increased water demand.
- Impact due to Construction of Bridge.
- Impact due to Supply of Construction Material.
- Impact due to Construction near Archaeological Structures, and
- Noise Pollution.

### **Soil Erosion, Pollution and Health Risk at Construction Site**

Run off from unprotected excavated areas can result in excessive soil erosion, especially when the adorability of soil is high. Mitigation measures include careful planning, timing of cut and fill operations and re-vegetation. Problems could arise from dumping of construction spoils (Concrete, bricks) waste materials (from contractor camps) etc. causing surface and ground water pollution. However, it is proposed to have mix concrete directly from batching plant for use at site. Batching plants will be located away from the site and from human settlements. The other construction material such as steel, bricks, etc. will be housed in a fenced stored yard. The balance material from these yards will be removed for use/disposal.

### **Traffic Diversions and Risk to Existing Buildings**

During construction period, complete/partial traffic diversions on road will be required, as most of the construction activities are on the road but most of the roads are double lane. Hence, wherever possible, rather than completely blocking the roads it will be advisable to make these roads as one way to allow for operation of traffic together with construction activities.



Moreover, on both sides of the roads, a clear passage shall be maintained for smooth operation of traffic, emergency and local movements. Advance traffic updates/information on communication systems will be an advantage to users of affected roads. The mono rail corridor does not pose any serious risk to existing buildings.

### ***Problems of Excavated Soil Disposal***

The excavation will be limited to piling activities for foundation for pillars. There will not be major excavation since the corridor involves only elevated section.

### ***Increased Water Demand***

The water demand will increase during construction phase. Sufficient water for construction purpose is made available by digging borehole/bore well within the vicinity of the project site during the construction phase. Hence, there will be no negative impact on the residents living in the vicinity of tube wells whose water demand is met by municipal water.

### ***Utility/Drainage Problems***

Double Decker MMDDRTS System line is planned to run through the urban area at grade and elevated. The alignment will cross surface and utility services, viz. sewer, water mains, storm water drains, telephone cables, overhead electrical transmission lines, electric pipes, traffic signals etc. Since these affect construction and project implementation time schedule/ costs for which necessary planning/ action needs to be initiated in advance.

### ***Impact due to Construction on Ground Water***

Ground water contamination can take place only if chemical substances get leached by Precipitation of water and percolate to the ground water table. This is not the case with the present project, as the activity does not use any harmful ingredients, which could leach down to water table. Therefore, no impact on ground water quality is anticipated from the project during the construction phase. Proposed project will not alter the existing water.

### ***Impact due to Supply of Construction Material***

Double Decker MMDDRTS System construction is a material intensive activity. Different quantity of construction material will be required for construction of the corridor. Quarry operations are independently regulated activities and outside the purview of the project proponent. It is nonetheless, appropriate to give consideration to the environmental implications in selection of quarry sources since poorly run operations create dust problems, contribute noise pollution, ignore safety of their employees, or cause the loss of natural resources.



A case study of noise pollution in crowded localities in Chennai is presented. Noise level were measured at two very important locations situated on OMR, a software hub of the State, i.e., one near the Toll Plaza and the other at an intersection near SRP Tools. None of the places recorded the day time permissible value of below 45 dBA. The maximum recorded value was 105 dBA. Such a high noise pollution can seriously affect the health of the people as well as their functions. In order to reduce the noise level noise barrier has to be erected. One possible solution to tackle noise pollution is growing more number of trees in the surroundings..

### **Noise Pollution**

Construction noise in the community may not pose a health risk or damage to people’s hearing, but it can adversely affect people’s quality of life. To some degree, construction noise can be a contributing factor to the degradation of someone’s health in that it can cause people to be irritated and stressed and can interrupt their ability to sleep - all of which may lead to higher blood pressure, anxiety, and feelings of animosity toward the people or agencies responsible for producing the noise. Construction noise may disturb people at home, in office buildings or retail businesses, in public institutional buildings, at locations of religious services depending upon their vicinity to construction site. Construction noise is unwelcome during night time in residential areas during sleep; it can be equally unwelcome during the daytime in commercial areas if it interferes with people’s ability to conduct business. The major sources of noise pollution during construction are movement of vehicles for transportation of construction material to the construction site and the noise generating activity at the construction site itself. The Double Decker MMDDRTS System construction is equipment intensive. A noise prediction is carried out for Lmax and Leq for different combinations of construction equipments working simultaneously at a site. The Result of the noise prediction is presented in

### **Impacts Due To Project Operation**

Along with many positive impacts, the project may cause the following negative impacts. During operation of the project due to the increase in the number of passengers and trains at the stations:

- Noise pollution,
- Water supply and sanitation at Stations,
- Refuse disposal and sanitation, and
- Pedestrian movement and visual issues.





**Noise Level Prediction during Construction**

Distance in m	Concrete Batch Plant+ Concrete Mixer Truck		Auger Drill Rig +DumpTruck + Generator +Slurry Plant		Dump Truck +Excavator + Pneumatic Tools	
	Lmax	Leq	Lmax	Leq	Lmax	Leq
10	97	91.8	98.3	96.8	99.2	97.6
25	89	83.8	90.4	88.9	91.2	89.6
40	84.9	79.7	86.3	84.8	87.1	85.5
50	83	77.8	84.4	82.9	85.2	83.6
75	79.5	74.3	80.8	79.3	81.7	80.1
100	77	71.8	78.3	76.8	79.2	77.6

**Noise Pollution**

During the operation phase the main source of noise could be from running of mono rail cars. Noise radiated from train operations and track structures generally constitute the major noise sources. Airborne noise is radiated from elevated structures. However, as per manufacturers of mono rail cars, noise generated from its operation is not significant.

**Water Supply and Sanitation**

Public Health facilities such as water supply, sanitation and wash rooms are very much needed at the stations. The water demands will be on station for drinking, toilet, cleaning and also for other purpose like AC, chillers and other purposes. In addition, water will be required for contractor’s camps during construction. The water requirement for the stations will be met through the public water supply system after taking necessary approvals. However as an environmental conservation measure, rainwater harvesting will be also carried out at stations.

**Station Refuse**

The collection and removal of refuse from MMDDRTS System stations in a sanitary manner is of great importance for effective vector control, nuisance abatement, aesthetic improvement and fire protection. The refuse from railway station includes;

- Garbage,
- Rubbish, and
- Floor Sweepings.

Since, MMDDRTS System is a new system in India and there is no past experience in Indian cities, no data is available for station refuse for MMDDRTS System projects in India. Thus, taking data for metro stations in Delhi and other places it can be assumed that the solid waste generation will be about 0.2 – 0.3 cum/day at each stations.



Thus about 2.6- 3.9 cum of solid waste will be generated from all the stations. The maintenance of adequate sanitary facilities for temporarily storing refuse on the premises is considered a responsibility of the operator of MMDDRTS System.

### **Impacts Due To Depot**

Depot is planned for **MTC TRANS** Depot will be near MAHABALIPURAM at Poonjeri. The area here is barren and with no habitation. In order to develop these areas as depot, it will need filling by earth brought from outside. The depots will have following facilities:

- Washing Lines.
- Operation and Maintenance Lines.
- Workshop, and
- Offices.

Problems anticipated at depot sites are Water supply, Oil Pollution, Cutting of trees, Sanitation, Effluent Pollution, Noise Pollution, Impact due to filling of area and Surface drainage.

### **Positive Environmental Impacts**

Based on project particulars and existing environmental conditions, potential impacts that are likely to result from the proposed development have been identified and wherever possible these have been quantified. This Section deals with the positive impacts of the project. The introduction of the project will also yield benefits from no tangible parameters such as saving due to equivalent reduction in road construction and maintenance, vehicle operating costs, less atmospheric air pollution and socio-economic benefits of travel time, better accessibility, better comfort and quality of life. However, all benefits cannot be evaluated in financial terms due to non-availability of universally accepted norms.

The parameters such as economic growth, improvement in quality of life, reduction in public health problems due to reduction in pollution, etc have not been quantified.

Various positive impacts have been listed under the following headings:

- Employment Opportunities.
- Enhancement of Economy.
- Mobility.
- Safety.
- Traffic Congestion Reduction.
- Reduced Fuel Consumption.
- Reduced Air Pollution.
- Carbon Dioxide and Green House Gases (GHG) Reduction.
- Reduction in Number of Buses, and
- Saving in Road Infrastructure.



### Checklist of Impacts

The impact evaluation determines whether a project development alternative is in compliance with existing standards and regulations. It uses acceptable procedures and attempts to develop a numeric value for total environmental impact. A transformation of the review of multiple environmental objectives into a single value or a ranking of projects is the final step in impact assessment. There are about hundred methods for carrying out impact assessment, which can be grouped into the following categories:

S. No.	Parameter	Negative Impact	No Impact	Positive Impact
A.	Impacts due to Project Location			
i.	Displacement of People	*		
ii.	Change of Land use and Ecology	*		
iii.	Loss of Cultural and Religious Structures	*		
iv.	Drainage & Utilities Problems	*		
B.	Impact due to Project Design			
i.	Platforms - Inlets and Outlets		*	
ii.	Ventilation and Lighting		*	
iii.	Railway Station Refuse	*		
iv.	Risk due to Earthquakes		*	
C.	Impact due to Project Construction			
i.	Soil Erosion, Pollution and Health risk	*		
ii.	Traffic Diversions and Risk to Existing Buildings	*		
iii.	Problems of Soil Disposal and Seepage Risk	*		
D.	Impact due to Project Operation			
i.	Oil Pollution	*		
ii.	Noise	*		
iii.	Water Demands	*		
iv.	Pedestrian Issues		*	
v.	Visual Impacts		*	
vi.	Employment Opportunities			*
vii.	Enhancement of Economy			*



Network,  
 \_ Overlays,  
 \_ Environmental Index and  
 \_ Cost Benefit analysis.

Each of the methods is subjective in nature and none of these is applicable in every case. Of the 7 methods listed above, checklist has been used and presented. Checklist is a list of environmental parameters or impact indicators which encourages the environmentalist to consider and identify the potential impacts. A typical checklist identifying anticipated environmental impacts is shown in .

S. No.	Parameter	Negative Impact	No Impact	Positive Impact
viii.	Mobility			*
ix.	Safety			*
x.	Traffic Congestion Reduction			*
xi.	Less fuel Consumption			*
xii.	Less Air Pollution			*
xiii.	Carbon dioxide Reduction			*
xiv.	Reduction in Buses			*
xv.	Reduction in Infrastructure			*

**Environmental Management Plans**

The MTC TRANS project in Chennai will provide employment opportunity, quick mobility service and safety, traffic congestion reduction, less fuel consumption and air pollution on one hand and problems of muck disposal, traffic diversion, utility dislocation etc. on the other hand, management of Environment by provision of necessary safeguards in planning of the project itself can lead to reduction of adverse impacts due to a project.

The most reliable way to ensure that the plan will be integrated into the overall project planning and implementation is to establish the plan as a component of the project.

**Mitigation Measures**

The main aim of mitigation measures is to protect and enhance the existing environment of the project. Hence mitigation measures have been suggested to include:

- Compensatory A forestation.
- Construction Material Management.
- Labor Camp.
- Energy Management.
- Hazardous Waste Management.
- Housekeeping.



- Utility Plan.
- Air Pollution Control Measures.
- Noise Control Measures.
- Vibration Control Measures.
- Traffic Diversion/Management.
- Soil Erosion Control.
- Muck Disposal.
- Water Supply, Sanitation and Solid Waste management.
- Management Plans for Depot, and
- Training and Extension.

Today there is no organized public transport system in the city except a auto, call taxi, private office busses plying at erratic schedule with the result the city's narrow streets are cluttered with private vehicles particularly 2 wheelers during peak hours. Traffic survey has brought out that the per capita transit trips in the city would be and the total transit trips 63,240 lakhs per year. Therefore a reliable and safe public transport system is essential for the very survival of the city itself and also to accelerate its economic recovery. The public transport system has to be either a bus Rapid transit system, or a light elevated metro or a Monorail system. BRT will need a dedicated bus corridor. This would require widening of the streets to accommodate lanes of traffic in each direction which is impossible in this city due to its heavily built up nature and stiff resistances to land and property acquisition. Therefore a BRT system has to be ruled out. The narrow streets, steep gradients, and very sharp curves also eliminate the possibility of adopting an elevated light metro system. The overhead deck required for such a Metro line would completely block air and light to the streets below. A light Metro has a carrying capacity of 10,000 to 20,000 PHPDT. Such a high capacity public transport system is not sustainable in a city like Chennai. Therefore the only option in the city for a public transport system is which can have sharp curves, steep gradients and which will not block air and light. **MTC TRANS** trains with two coaches running at 6 minutes interval is more than enough to cater to the transportation needs of the city till the year. Therefore a **MTC TRANS** system, starting from *Mamallapuram to Thiruvanmiyur Bus Stand* of end for a Length of 42km with 36 stations at an estimated cost of Rs 4078 Corers is recommended for Chennai city as Phase I of the project.

UITPI has the required technical manpower and experience for executing a project of this magnitude. If UITPI is handling the project there is a reasonable possibility of the project getting completed within a period of 3 years.





The State Government after approval had taken a decision to engage UITPI as consultants for **MTC TRANS** Double Decker maglev magnetic light rail system project. If UITPI is to handle both the projects together, economy of scale is possible reducing the overall time and costs for both the projects. This will also promote indigenization and vendor development in the country.

UITPI can also hand-hold the UITPI for recruitment and training of O&M staff and over see the operational system for a year or two by which time UITPI should develop confidence and expertise to run the system themselves. It is also recommended, UITPI should introduce feeder services with air-conditioned mini buses from important areas of the city to the stations to improve the overall public transport system in the city as also to improve ridership on the Trans system. An MMDDRTS needs discipline and orderliness on the part of commuters for its smooth functioning. The public have to be constantly educated as to how to use the system and keep the trains and premises clean. This should call for an effective public relation department with UITPI.

The system ideally should not depend upon the Government for any subsidy for its operation and maintenance, as also for servicing and paying back the loans taken. For this, it is necessary to ensure that the capital cost is kept to the minimum. State taxes generally accounts for 6 to 8% of the project cost. It is recommended that the State Government gives complete remission of State taxes and duties to this project. Similarly, being a pioneering project in the country and to make popular to the medium sized cities, Government of India should also extend duty and tax concessions to this project which will also help to bring down the capital cost further by about 10%. Government of India has given similar concession to Delhi Metro Rail Corporation for the 1st and 2nd phase of the Delhi Metro. A similar treatment and encouragement is necessary for the projects in the country, at least in the initial stages.

To make the project financially sustainable it is also necessary to reduce the O&M costs. Cost of energy for running trains and the various systems account for 40% of the O&M cost. The State Government should treat the services as a special category and recommend to the electricity regulatory authority a special power tariff to this project on “no loss no profit” basis. Delhi Metro enjoys such a special electricity tariff. The manpower cost accounts for 25 to 30% of the O&M costs. As strict control on the manpower yard stick is therefore necessary right from the beginning. Further, the work culture, ethics and values of the organization should ensure maximum productivity and excellent customer satisfaction. This has to be ingrained in the organization right from the beginning.

Since the project is being implemented mostly through loans and UITPI will have the responsibility to service and pay back the loans, no fare concession to any section of society is to be allowed till all the loans are paid back. All efforts to augment the fare collections from advertisements, parking fees and commercial exploitation of surplus lands and station spaces



should be attempted. If all the above steps are taken the **MTC TRANS** System can be made self-supporting.

### **Way Forward**

We would suggest the following actions to take the project forward for its early completion. The State Government should approve the Detailed Project Report and authorize to hand over the project to an organization like UITPI for implementing on a turn-key basis and under deposit terms. The State Government should approach Ministry of Urban Development, Government of India, Ministry of finance, Government of India and Planning Commission for

- To part fund the project with a grant of 20% of the cost.
- To exempt the project from all central taxes and duties for a period of 3 years and to bring the project under the legal cover of Delhi Metro Railway Act. 3) Set up a Special Purpose Vehicle to own and operate this project. Government should also select an outstanding technocrat with impeccable integrity to head the SPV.
- Government should give guarantee for the loans raised for the project.
- Government should set up an empowered Committee of Secretaries under the Chairmanship of the Chief Secretary to monitor the land acquisition work on a fortnightly basis and also for interdepartmental coordination.
- In addition, Government should also set up a group of Ministers to monitor the project and accord all necessary sanctions at Cabinet level.

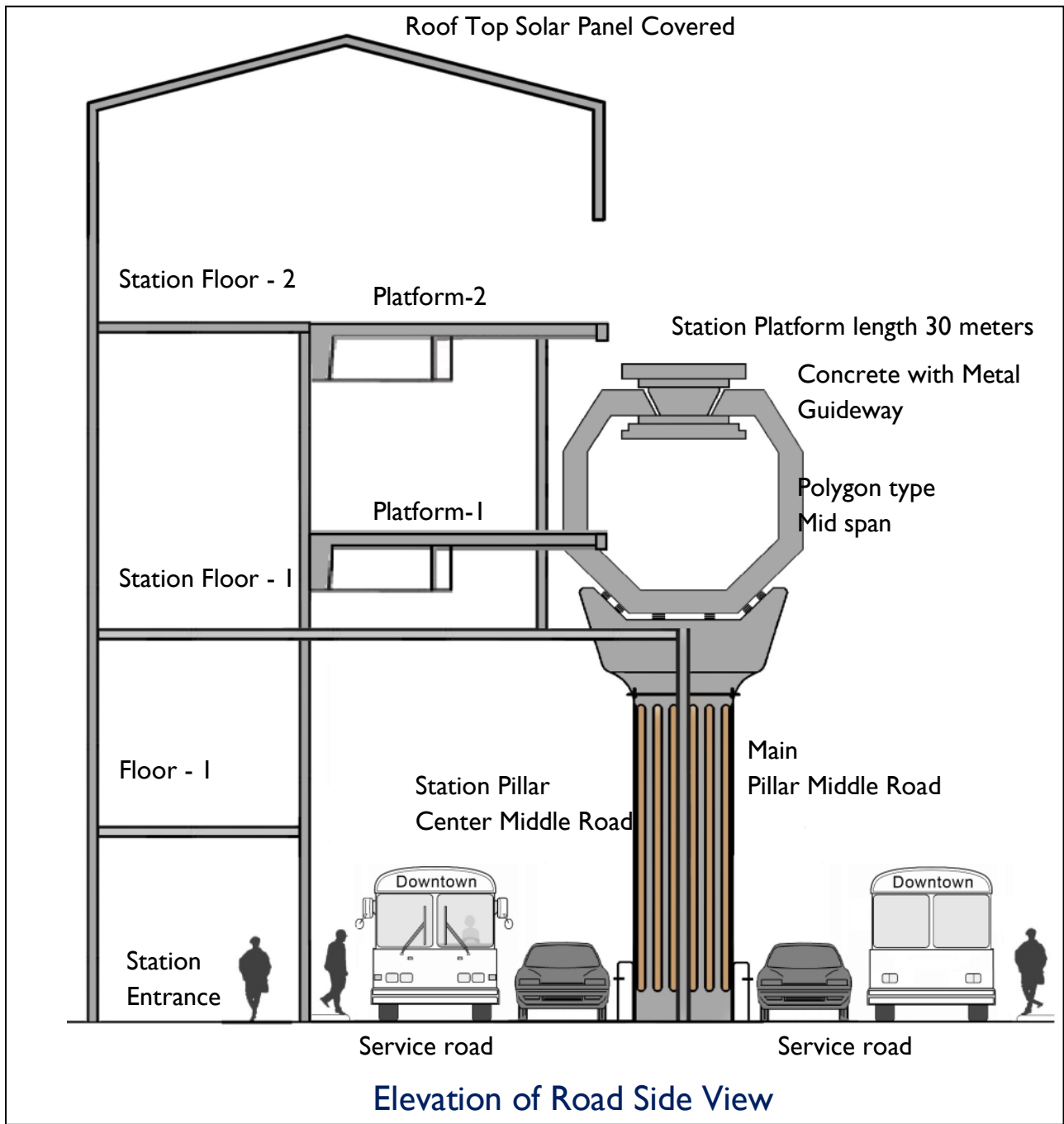



## **24 - GLOBAL MULTI NATIONALS AND MTC TRANS SYSTEM**

Most of these civil works or supply of equipments are made by global multinational companies or major civil contractors in the Country list of the major contractors/suppliers of MTC Trans.

### ***Design & Construction of Civil Works***

Hindustan Construction Company, India.

Larsen & Turbo, India.

Samsung Corporation.

IRCON International, India.

### ***Rolling Stock***

Siemens.

Bombardier.

Mitsubishi Corporation, Japan.

KORES, Korea.

Mitsubishi Electric Corporation, Japan.

### ***Signalling***

Alstom Transport Ltd India

Alstom Transport, France

Alcatel Portugal SA

### ***Power Distribution/Traction etc***

ABB India

Best & Crompton

### ***Automatic Fare Collection***

Alcatel CGA Transport, France

### ***ABB solutions for solar energy Solar technologies for power generation***

Environment friendly energy is one of the biggest global challenges we face today and major companies are at the heart of this issue. This is because the world expects them to come up with new technologies and systems to produce energy with reduced pollution and greenhouse gas emissions, widely recognized as one of the main causes of global warming.

Solar energy can be used to generate electricity either directly using photovoltaic panels, or indirectly using solar thermal panels to produce heat which is then converted into electrical power. In both cases, maximum yields can only be achieved by adopting equipment and components that guarantee the highest levels of quality with a range of products wide enough to meet the needs of every kind of plant.



**Boallttasgeo Marine Consultant**

To introduce ourselves as one of the leading Geotechnical consultants based in Chennai. We have been in continuous operation since 1994 and have carried out various geotechnical engineering works for the projects of Government Organizations and for the private sectors throughout India. Our work has been carried out in full co-operation with our clients and to their entire satisfaction

- Topographic / Hydrographic Survey.
- Site Investigations.
- Soil sampling using rigs on land in marine condition, river beds, back water, reservoir and in Open sea.
- Rock core drilling,
- Offshore Drilling.

Drilling & Grouting field test such as standard penetration test, Static cone penetration and dynamic cone penetration test, Plate load test and the like,

- Laboratory test on soil and rock.
- Analysis and collation of test results.
- Foundation designs such as for pilling etc.
- Design for ground improvement works (rammed stone columns and drains etc).
- Reports on investigation Mobile:
- +91-9444773802, +91-8124095900 Phone: 044- 42134581, 044 - 43548791, 044-32425113

**Valecha Engineering Ltd**

Valecha Engineering Ltd., is an ISO 9001:2000 certified company presently lead by Mr. J.K. Valecha and engaged in civil engineering. Established in 1957, Valecha Engineering Ltd is a significant beneficiary of the infrastructure thrust witnessed by the Indian sub-continent, mainly in the road development sector. The company listed in the Bombay stock Exchange has created some of the most prominent civil engineering infrastructure landmarks of India and has positioned itself as a globally accepted construction and infrastructure development company Valecha Engineering, a leading player in the construction industry having a Group Turnover of Rs.3000 Million, is engaged in the construction of major infrastructure & engineering projects such as Irrigation Dams, Reservoirs & Canals, Roads, Highways & Expressways ,Bridges & Tunnels Railways, Airports, Foundation & Piling Works.





## WORKING MODEL- SNAPSHOTS

SNAP SHOT PICTURES OF THE WORKING MODEL FOR THE IAT- MAGLEV

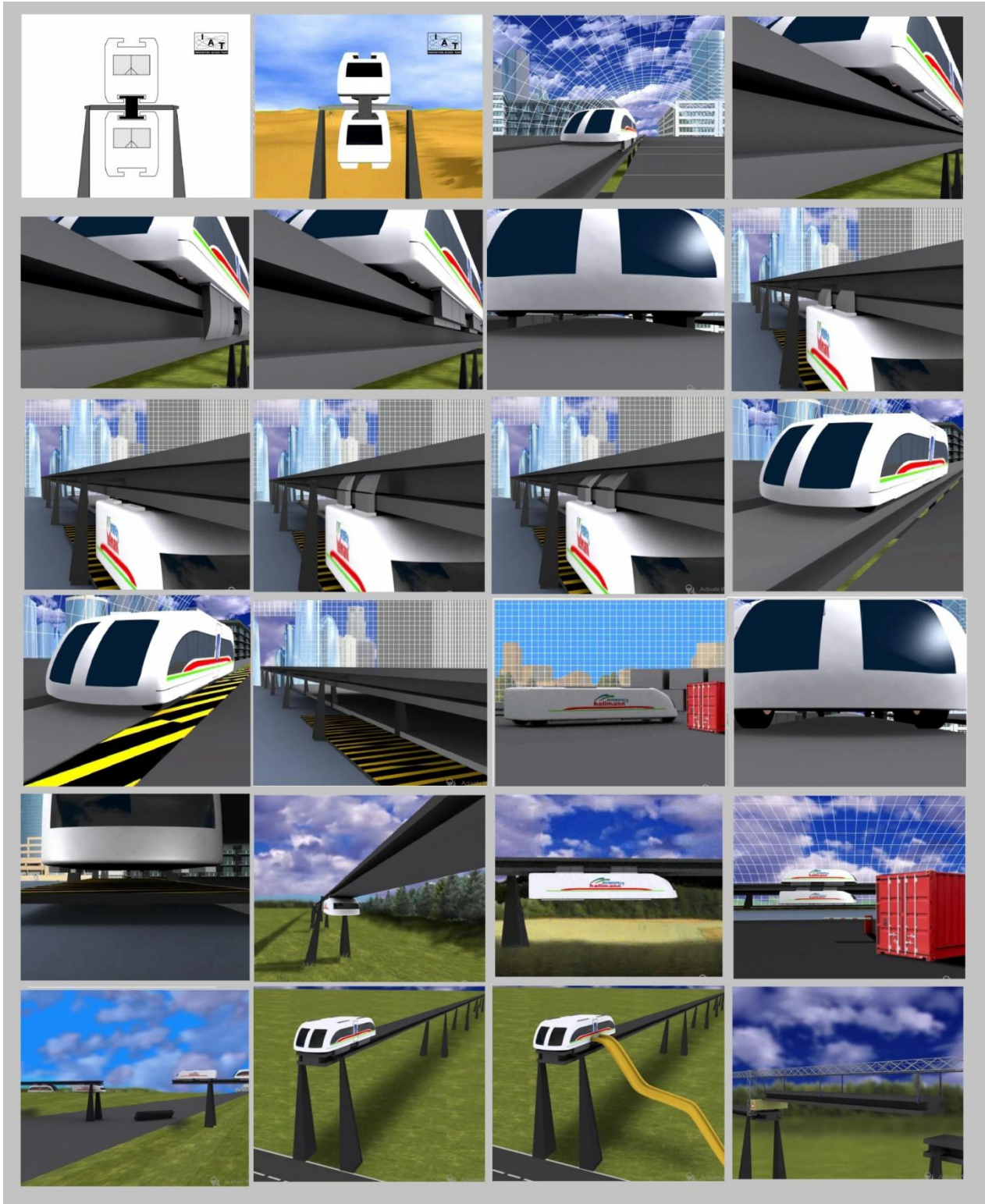

<https://youtu.be/csaSJVUxk9Y>



# NEW MAGLEV MAGNETIC DOUBLE DECKER-SYSTEM

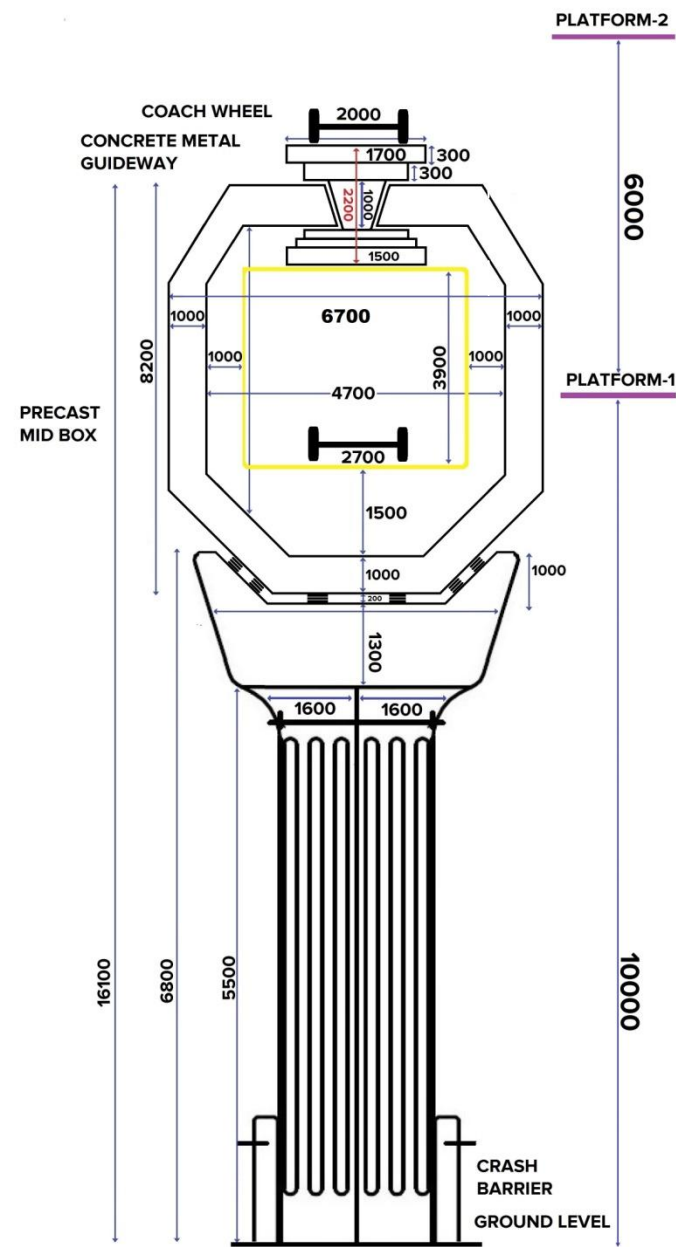

**MTC TRANS RAPID SYSTEM MAIN PILLAR**

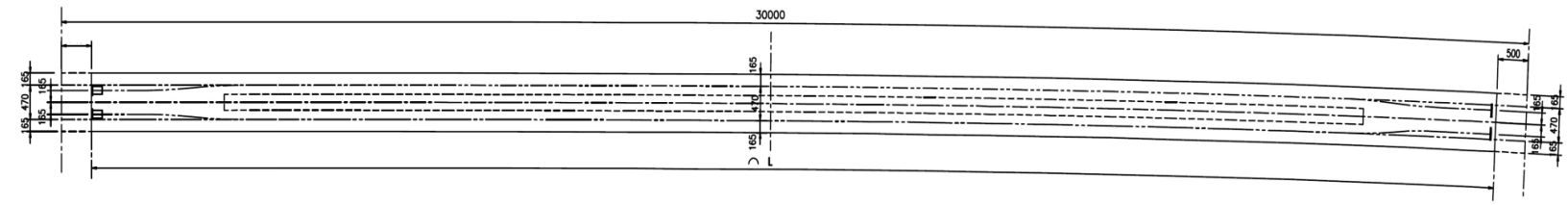

**Concrete maglev Magnetic Guidway 25**

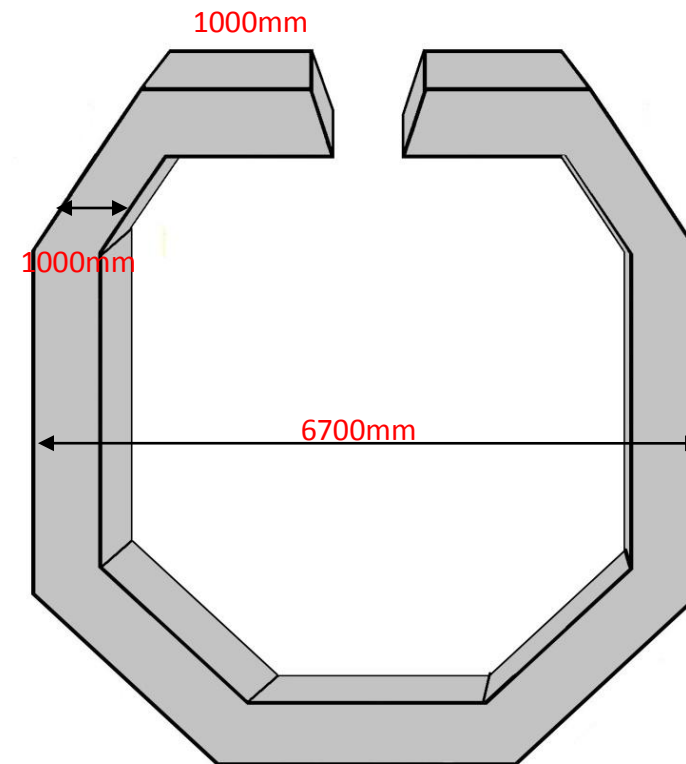

**POLYGON TYPE CONCRETE MID SPAN**

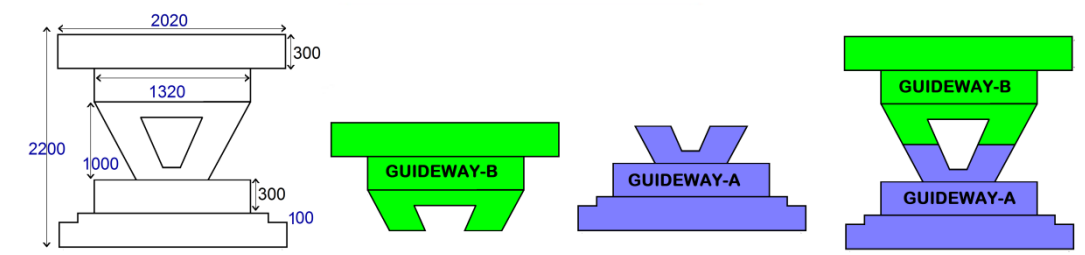

**GUIDEWAY PARTS-A AND B**

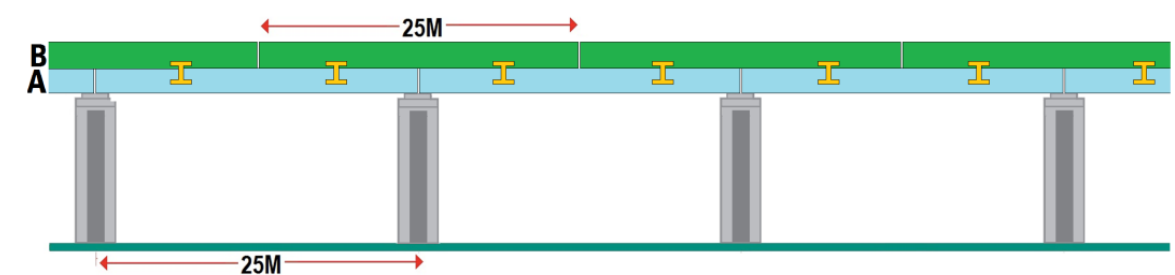

**CONCRETE PILLAR WITH GUIDEWAY**

All Dimension Are In Millimetres  
 All Dimensions Are To Be Read and Not Measured  
 Any Discrepancies Must Be brought to the notice architect before  
 executions of work at site

## MTC TRANS Rapid System Main Pillar

MTC TRANS RAPID SYSTEM			
Main Pillar Plan			
Drawing number	Scale nts	Date	Sheet size A-3



THE COACHES WILL REST ON WHEEL SUPPORT AT STATION AREA

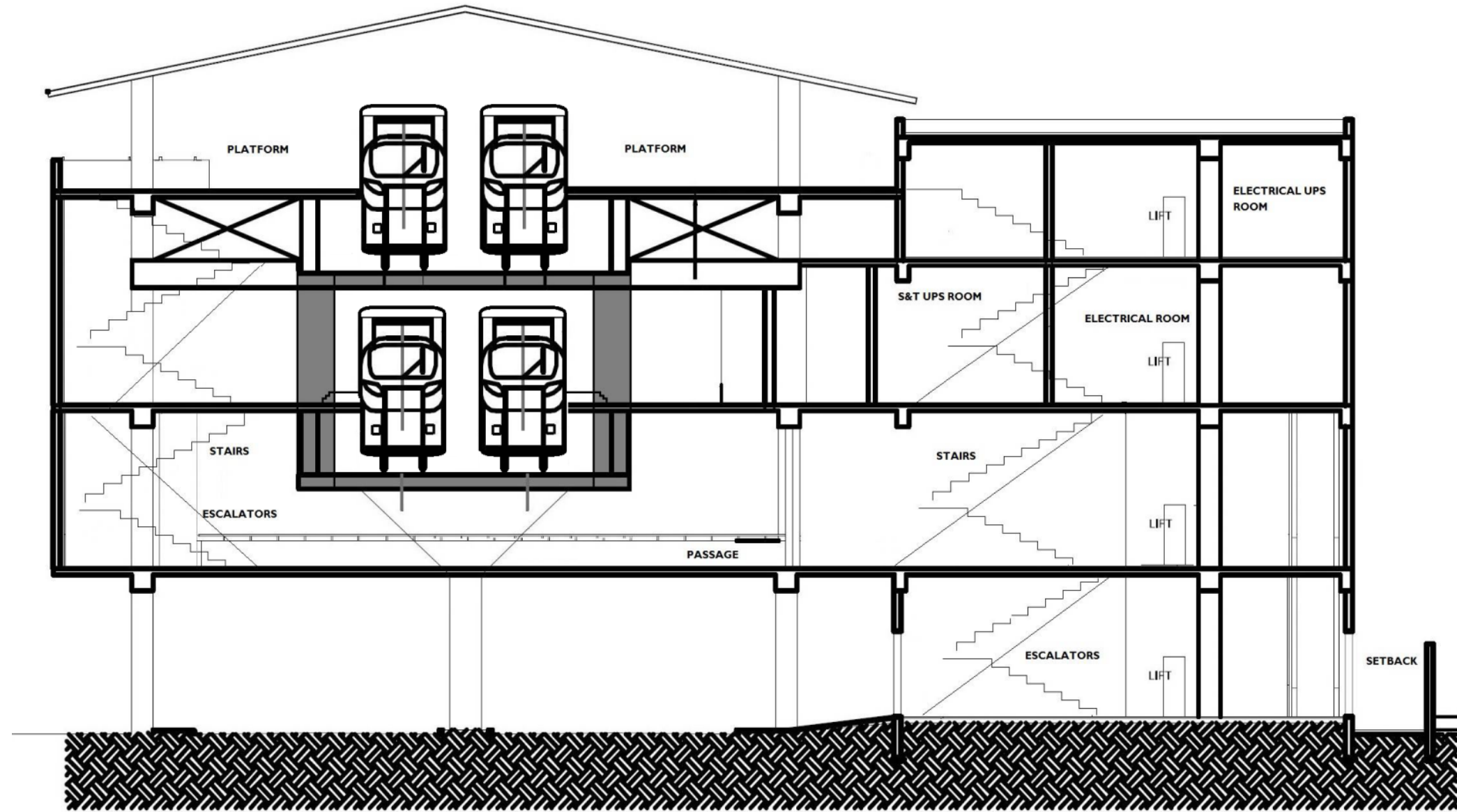

All Dimension Are In Millimetres  
 All Dimensions Are To Be Read and Not Measured  
 Any Discrepancies Must Be brought to the notice architect before  
 executions of work at site

### MTC Trans Main Station Plan

MTC TRANS RAPID SYSTEM

TYPE-A

Drawing number	Scale NTS	Date	Sheet size A-3
----------------	-----------	------	----------------

THE COACHES WILL REST ON MAGNETIC GUIDEWAY SUPPORT AT STATION AREA

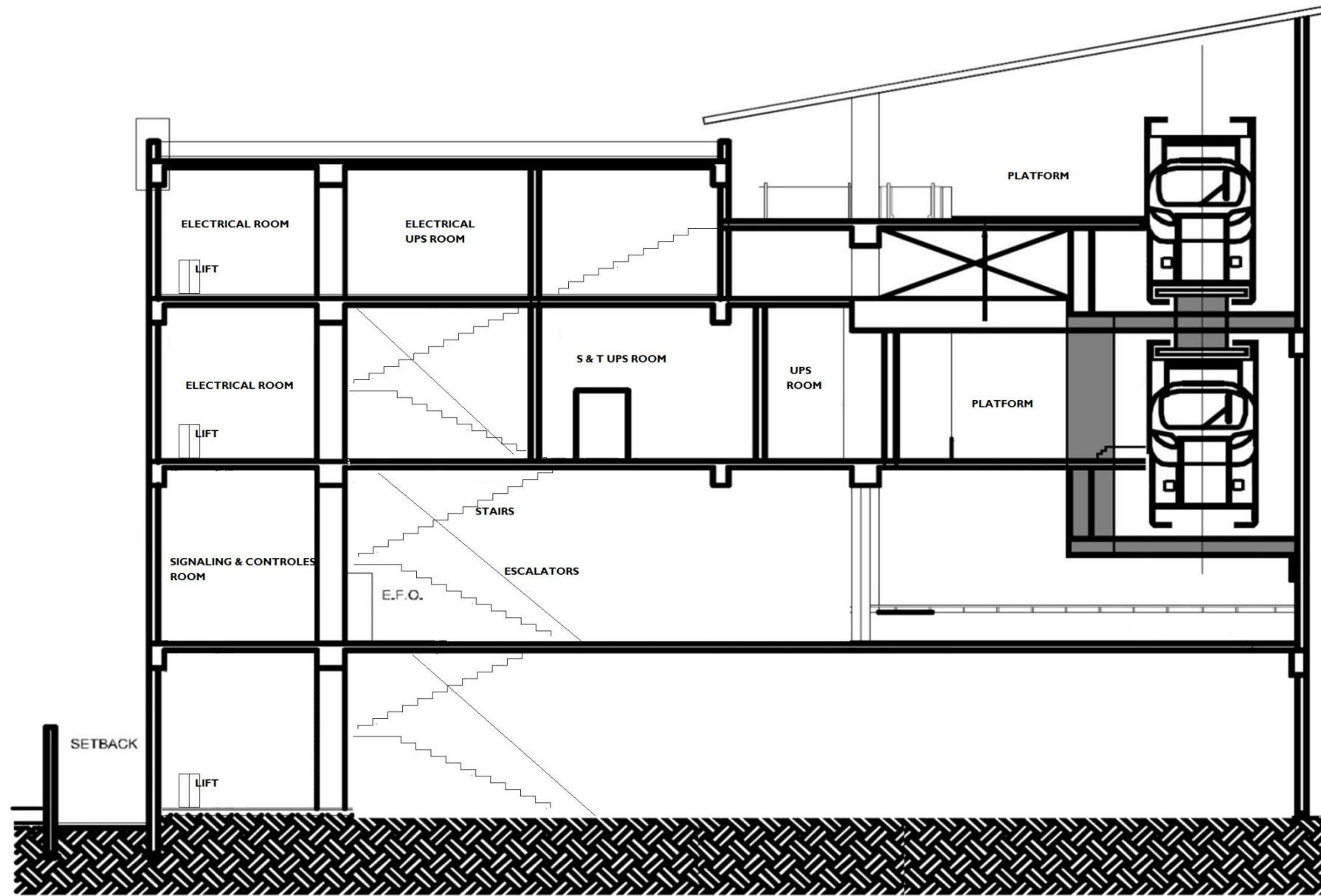

All Dimension Are In Millimetres  
 All Dimensions Are To Be Read and Not Measured  
 Any Discrepancies Must Be brought to the notice architect before  
 executions of work at site

### MTC Trans Internal Station Plan

MTC TRANS RAPID SYSTEM

TYPE-B

Drawing number	Date	Scale NTS	Sheet size A-3
----------------	------	-----------	----------------

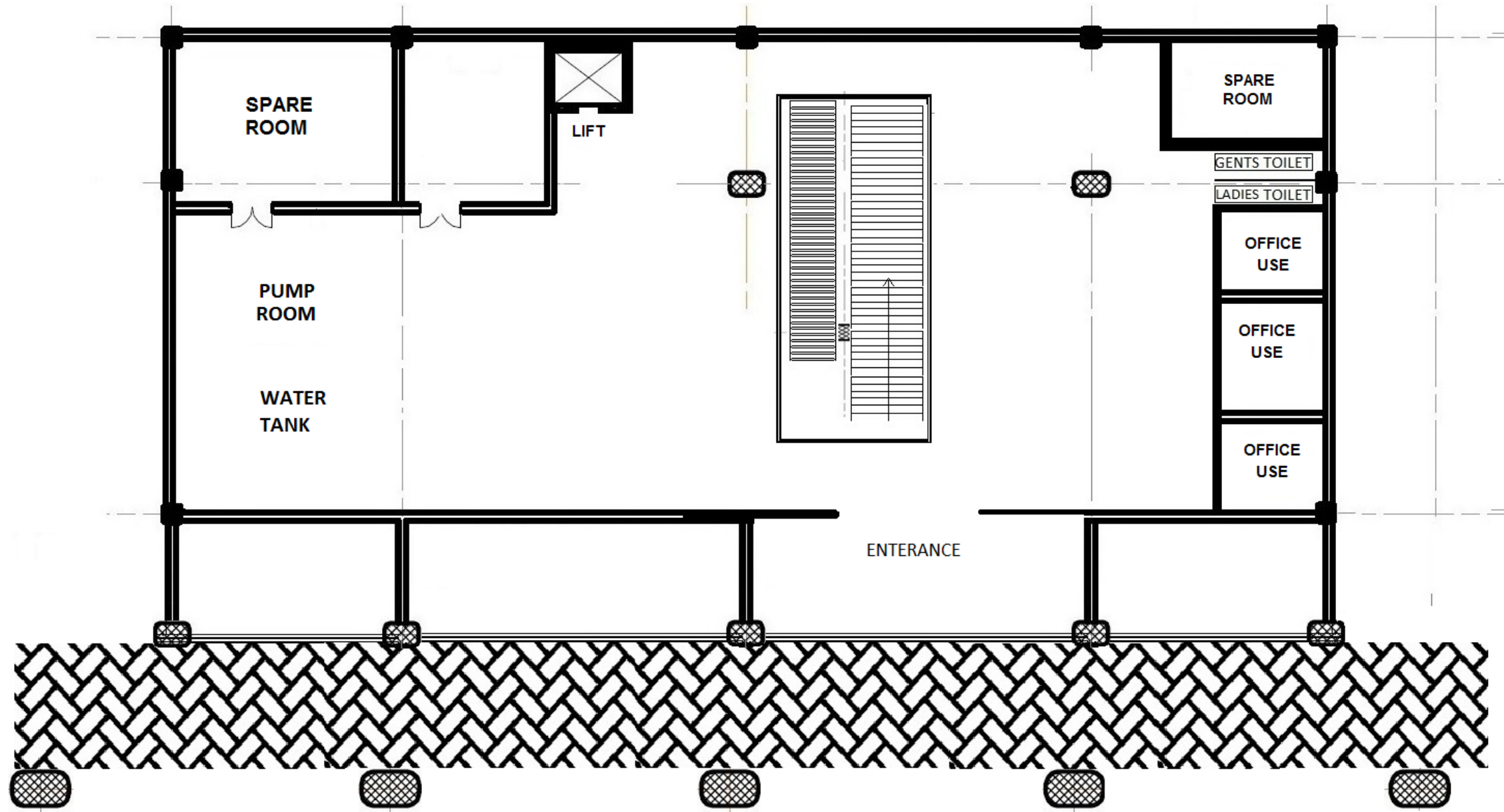

All Dimension Are In Millimetres  
 All Dimensions Are To Be Read and Not Measured  
 Any Discrepancies Must Be brought to the notice architect before  
 executions of work at site

### MTC TRANS Station Ground Floor Plan

MTC TRANS RAPID SYSTEM

Ground Floor plan Type-B

Drawing number	Scale NTS	Date	Sheet size A-3
----------------	-----------	------	----------------



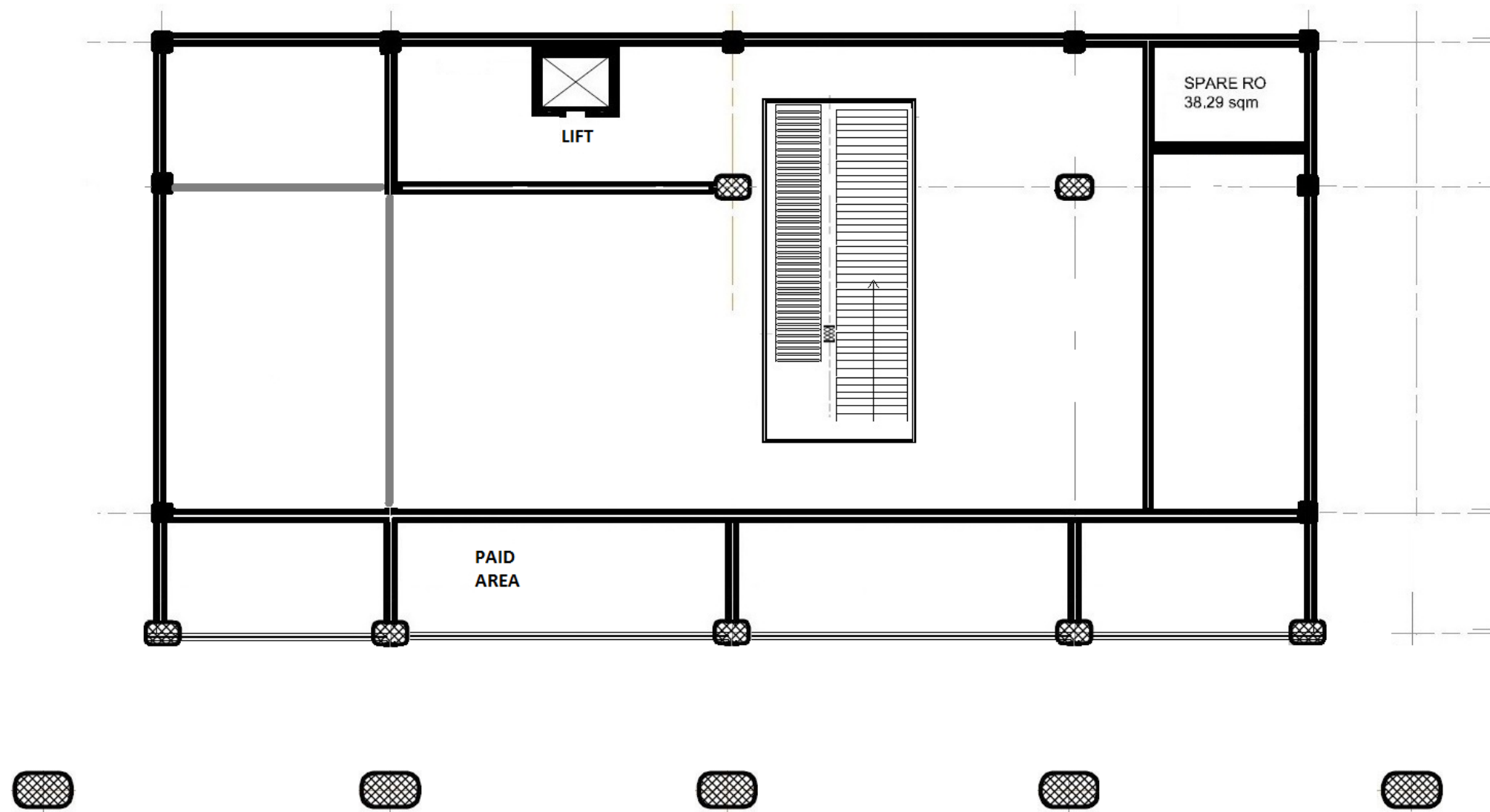

All Dimension Are In Millimetres  
 All Dimensions Are To Be Read and Not Measured  
 Any Discrepancies Must Be brought to the notice architect before  
 executions of work at site

### MTC Trans Platform 1 Floor Plan

MTC TRANS RAPID SYSTEM

Platform Level 1 Plan Type-B

Drawing number	Scale NTS	Date	Sheet size A-3
----------------	-----------	------	----------------

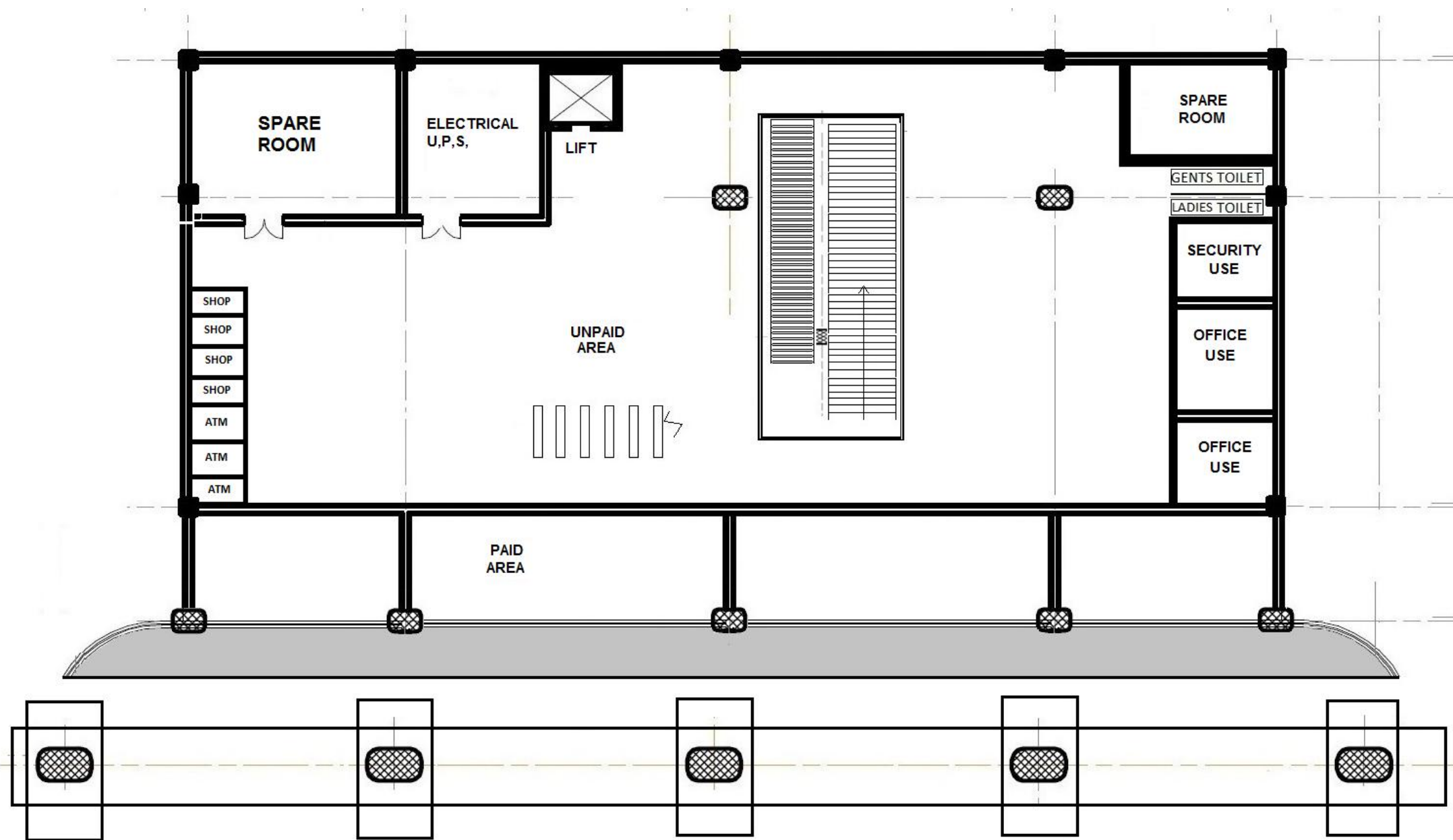

All Dimension Are In Millimeters  
 All Dimensions Are To Be Read and Not Measured  
 Any Discrepancies Must Be brought to the notice architect before  
 executions of work at site

### MTC Trans Station Platform 1 Floor Plan

MTC TRANS RAPID SYSTEM			
First Floor Plan Type-B			
Drawing number	Scale NTS	Date	Sheet size A-3

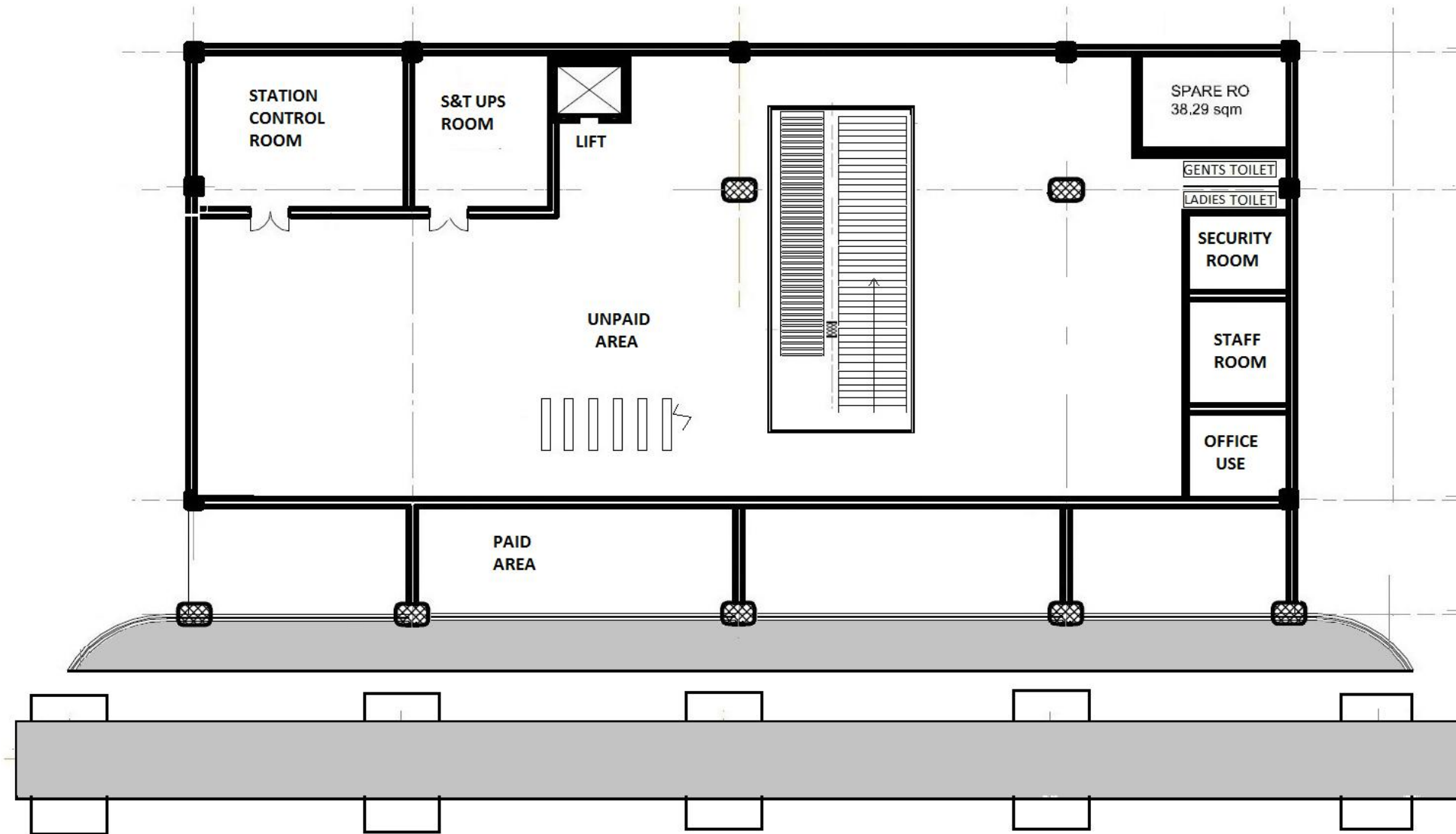

All Dimension Are In Millimeters  
 All Dimensions Are To Be Read and Not Measured  
 Any Discrepancies Must Be brought to the notice architect before  
 executions of work at site

### MTC Trans Station Platform 2 Floor Plan

MTC TRANS RAPID SYSTEM

Station Platform 2 Plan Type-B

Drawing number	Scale NTS	Date	Sheet size A-3
----------------	-----------	------	----------------

# MTC TRANS RAPID SYSTEM

## Depot Plan 2 Acre Land

1, MOVABLE PART THUS  
2, APPROXIMATELY DEPOT HEIGHT IS 9.5 M ABOVE THE NATURAL GROUND.

Work shop and bay

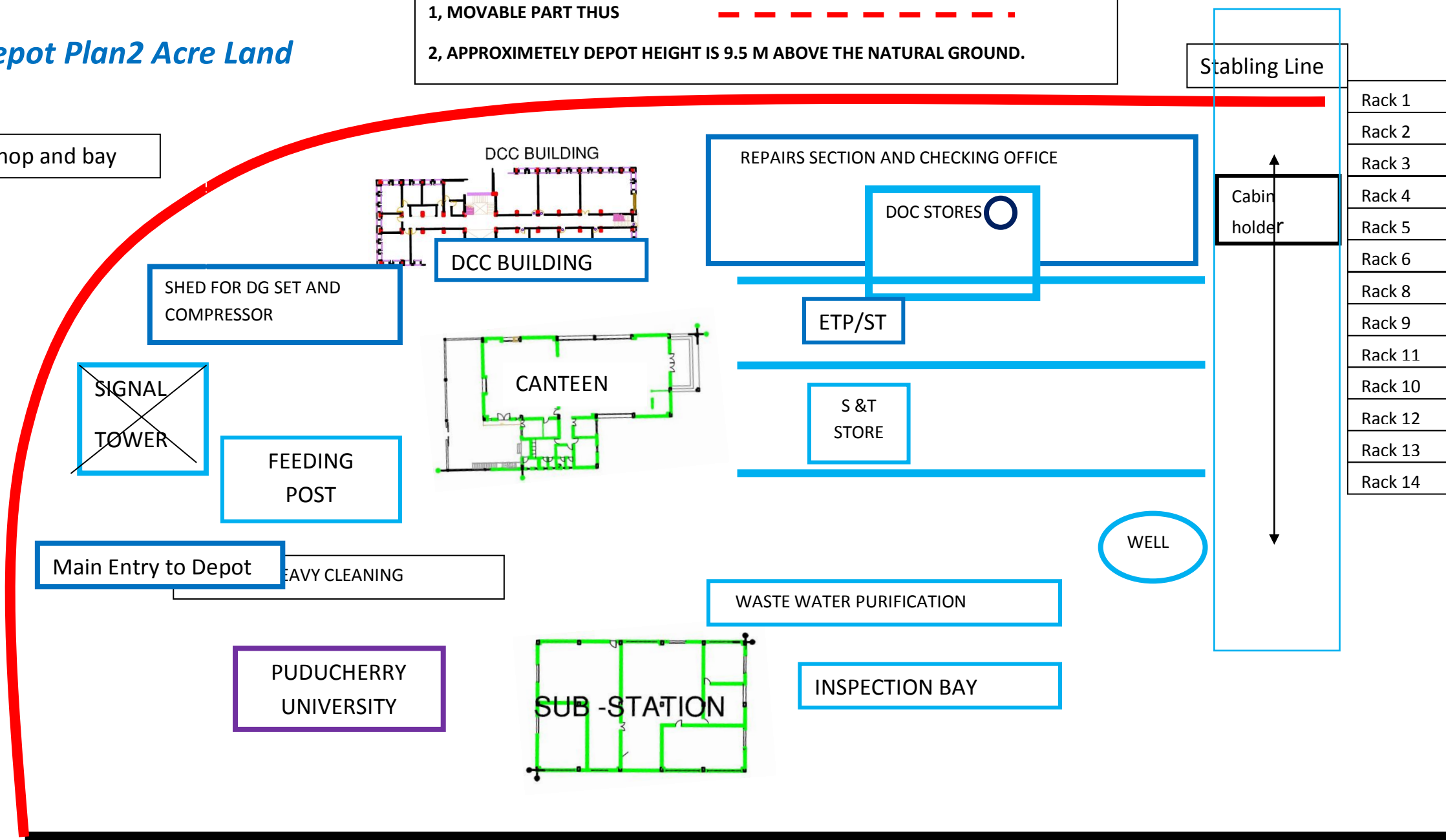

- Rack 1
- Rack 2
- Rack 3
- Rack 4
- Rack 5
- Rack 6
- Rack 8
- Rack 9
- Rack 11
- Rack 10
- Rack 12
- Rack 13
- Rack 14

20 MEGWATT SOLAR POWER PLANT 100 ACRE





Prepared by  
**FEASIBILITY REPORT & BUSINESS PLAN**  
**UNITY INFRA TRANSIT PROJECT IMPLEMENTERS**  
M. Dhoulat Sah  
38, Ibrahim Sahib Street  
Chennai-600001,  
TamilNadu,India  
044-25272030, 9025035771,  
dhoulatsah@gmail.com, pssrts@gmail.Com